

THERE IS **LIGHT**
AT THE END OF THE TUNNEL

LET'S FIND THE SOLUTION TOGETHER.





INSECT CONTROL

INSECTICIDES & PESTICIDE FREE	4-12
INSECT BAIT	13-16
SMOKE GENERATORS & AEROSOLS	17-19
INSECT TRAPS & TREATMENTS	20-36
RURAL & GRAIN STORE HYGIENE	37-40
INSECT, WEED & WOOD TREATMENTS	41-45
LED EFK's & REPLACEMENT PARTS	46-49
INSECT SAMPLING	50-51

RODENT CONTROL

RODENTICIDES	52-72
RODENT MONITORING & INDICATOR PRODUCTS	73-74
RODENT BAIT STATIONS & FIXINGS	75-85
SENSORY TECHNOLOGY	86-87
SNAP & LIVE CATCH TRAPS PLUS LURES	88-98
RODENT PROOFING	99-109
FUMIGANTS, REPELLENTS & DRAINAGE SYSTEMS	110-116
RODENT HYGIENE & DISINFECTANTS	117-122
DECANTING, TOOLS, PAPERWORK & LABELS	123-125

BIRD CONTROL

BIRD REPELLENTS & GUANO CLEANING	126-128
BIRD NETS	129-133
BIRD NET FIXINGS & ACCESSORIES	134-145
BIRD SPIKES, FIXINGS & SURFACE PREPARATION	146-149
BIRD WIRE, POSTS & FIXINGS	150-152
AVISHOCK & ACCESSORIES	153-155
BIRD MESH, PROOFING & TRAPS	156-159

APPLICATION EQUIPMENT

FOGGERS / THERMAL FOGGERS	160-163
SPRAYERS, ACCESSORIES & POWDER APPLICATION	164-171
DUSTERS	172-175
BAIT GUN APPLICATORS	176-177
DECANTING, MIXING & STORAGE	178-179
TORCHES, TOOLS & LADDERS	180-183
INSPECTION & MOTION CAMERAS	184-187
TECHNICAL MANUALS	188

PPE & SAFETY

PROTECTIVE CLOTHING	189-195
MASKS & FILTERS	196-200
BEE & WASP PROTECTION	201-203
BAGS & CARRY CASES	204-205
CHEMICAL SPILLAGE KITS & FIRST AID	206-207
HYGIENE, DISINFECTANTS & CLEANING TOOLS	208-212
TORCHES TOOLS & LADDERS	213-216
TECHNICAL INFORMATION	217-251

SUPPORTING YOUR BUSINESS.

SALES & TECHNICAL

Telephone 0117 967 2222

Email beh@barrettine.co.uk

ORDER & PAY ONLINE

www.barrettineEnv.co.uk

CUSTOMER SERVICE

support@barrettine.co.uk

REQUEST ACCOUNT

Contact our sales office by email or via our online website account form.

Please be aware you will be required to provide proof of your stewardship certification for compliance purposes.

CATALOGUE KEY



BPR and other restrictions may apply for Northern Ireland at time of shipping. These products have a PCS or BPD number and may therefore also be cleared for use in Southern Ireland.



Can be sprayed on mattresses.



Video demo available at www.barrettineEnv.co.uk

GENERAL CUSTOMER INFORMATION

The information and pricing in our catalogue is correct to the best of our knowledge at the time of print but maybe subject to change. We cannot accept any responsibility for loss or damage arising from any error or omission. Certain pictures, charts and text are copyright protected. You should seek permission/approval before copying or using any of the information provided within this catalogue. European Biocides Directive (BPD)/REACH & CPL: Certain products within our catalogue may not be supported fully by the manufacturer through the future stages of the biocides directive/REACH, as such may have to be removed from the market, but we will endeavour to inform all our customers of news as we get it but please check at the time of order if you have any concerns.

For the most up to date information, please regularly visit: www.barrettineEnv.co.uk. Alternatively, contact the Sales Office and ask to be added to our news mailing list.

NEW
2021

PRODUCTS

NEW
2021

PRODUCTS

NEW
2021

PRODUCTS



01
**Deadline
PyDust**
Insecticide

Page: 9



02
**Maxforce
Pushbox**
Ant control

Page: 13



03
**Cimetro
Super RTU**
Insecticide

Page: 19



04
CL-TRAC
Pre-baited
Clothes Moth
control

Page: 32



05
LED EFK's
Fly control

Page: 46

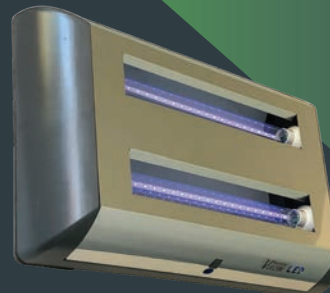

06
LED EFK's
Fly control

Page: 46/47

NEW 2021 PRODUCTS

NEW
2021

PRODUCTS

NEW
2021

PRODUCTS

NEW
2021

PRODUCTS

07

**Protecta
Evo Tunnel**
Rodent control

Page: 77

A grey plastic rodent control tunnel device with a bait station and a trigger mechanism.

08

Rat Tape
Rodent control

Page: 105

A box of Rat Tape and a roll of the adhesive tape, which is yellow with a black strip.

09

**Cable Ferret
Pro**
Rodent control

Page: 184

A yellow and black handheld rodent control device with a lens and a trigger.

10

**DuoMax
Disinfectant
Wipes**
PPE & Safety

Page: 208

A white plastic container of DuoMax disinfectant wipes with a label showing the brand name and product details.

11

**Alcohol
Hand
Sanitiser**
PPE & Safety

Page: 208

Two bottles of alcohol hand sanitiser: a smaller spray bottle and a larger jug-style bottle, both with blue labels.

12

**Alcohol
Surface
Cleaner**
PPE & Safety

Page: 208

Two bottles of alcohol surface cleaner: a smaller spray bottle and a larger jug-style bottle, both with blue labels and a yellow stripe.

NEW 2021 PRODUCTS



INSECTICIDES & PESTICIDE FREE

INSECT BAITS

SMOKE GENERATORS & AEROSOLS

INSECT TRAPS & TREATMENTS

BED BUG CLEANING & ELIMINATION

AGRICULTURAL & AMENITY

GRAIN STORE HYGIENE

WEED CONTROL

WOOD CARE TREATMENTS

ELECTRONIC FLY KILLERS

INSECT control

PRODUCTS 

PEST CONTROL CATALOGUE 2021

ALPHA SCT®



Combining the synergy of two pyrethroid molecules (10 % (w/w) Cypermethrin & 0.9 % (w/w) Tetramethrin), Alpha SCT offers the knockdown effectiveness of Tetramethrin and the well-known residual characteristics of Cypermethrin into a single product giving effective control of both flying and crawling insects.

For use on flies, moths, red poultry mite, beetles, fleas, ticks, bed bugs, cockroaches, crickets, silverfish, booklice, mites, ants, mosquitoes, wasps and centipedes. For use in and around domestic properties, public and municipal areas, refuse tips, poultry houses, slaughterhouses and manure heaps.

BUY 3 GET 1 FREE
25% OFF

1 x 500 ml

ORDER CODE: BALPSCTA

£68.41

CIMETROL SUPER EW



Contains Cypermethrin 25% w/w, Tetramethrin 10% w/w, Piperonyl Butoxide 20% w/w & Pyriproxyfen 1% w/w. Cimetro Super EW is the next generation of product for the control of insect pests (not spiders). Formulated as an oil-in-water emulsion containing a very high loading of active ingredient, it allows rapid access of the active ingredient to the insect while providing long-lasting and predictable residual control.

1 x 500 ml

ORDER CODE: BCIMESUP

£147.24

K-OTHRINE® PARTIX™



K-Othrine® Partix™ is a suspension concentrate containing 2.49% (2.45% pure) Deltamethrin, with broad-spectrum insecticidal activity. K-Othrine® Partix™ can be used indoors in domestic, commercial and industrial premises to control crawling insects (including cockroaches and bedbugs), house flies at rest and spiders and for the outdoor control of wasps in free hanging nests. K-Othrine® Partix™ gives pest controllers the power to control a broad spectrum of pests on any surface whilst significantly reducing active substance levels in the environment.

1 x 250 ml

ORDER CODE: BKOPT250

£51.43

AQUAPY® & AQUAPY® MICRO

IR



Contains 30 g / litre of pyrethrins synergised with 150 g / litre Piperonyl Butoxide. AquaPy is a water-based formulation ideal for space treatments against flies, mosquitoes, moths, tobacco beetles on the wing and other stored product insects. AquaPy micro bottle can attach directly to certain ULV machines, Accepted for Use in Organic areas/sites. (Requires PA1 and PA9 certificate for fogging grain stores and agricultural applications). IR (93571) Standard outer 12

1 x 1 Litre

ORDER CODE: BAQUA001

£95.35

1 x 1 Litre Micro

ORDER CODE: BAQUAMIC

£108.65



International

Stop bedbugs becoming a nightmare

Avoid costly call backs with PelGar's award winning Cimetro Super. The unique blend of active ingredients, including the insect growth regulator pyriproxyfen, deliver rapid and long lasting control of bedbugs and other crawling insects.



NEW
RFU SPRAY BOTTLE

www.PelGar.co.uk

▶ Rodent Control ▶ Insect Control ▶ Plant Protection ▶ Insect Repellents ▶ Decontamination Kits

Concentrate Contains: cypermethrin 25% w/w, tetramethrin 10% w/w, piperonyl butoxide 20% w/w and pyriproxyfen 1% w/w.
Use biocides safely. Always read the label and product information before use.



We've made it
SUPER EASY

TO ORDER ONLINE

BarrettineEnv.co.uk



BIOPREN 6 EC



A highly effective formulation containing the insect growth regulator s-methoprene 6.74 % (w/w), as well as a flushing agent and knock-down insecticide pyrethrins 4.81 % (w/w). Suitable for both bed bugs and fleas.

1 x 500 ml

ORDER CODE: BBIOPREC

£82.67

FLYMAX® G3



Flymax® Super G3 is a novel polymer formulation combined in a water-based delivery system that gives rapid knockdown of flies, ants, fleas, bed bugs and small insects. This product can be used in a wide array of environments. Due to its physical mode of action, Flymax® Super G3 is effective against insect strains that are resistant to organophosphate and pyrethroid insecticides. Use in Public Health / Refuse Tips: Effective in controlling most types of common flying & crawling insects, including flies, ants, fleas, mosquitoes, moths and bed bugs etc. Use in Agricultural Situations: Effective in controlling stored product insects including grain pests, litter beetle, flying insects such as house fly, cluster fly, mosquitoes, etc. (can be applied as surface spray while livestock is present but avoid direct contact with livestock/animals).

1 x 5 Litre

ORDER CODE: BFLYMAX3

£30.45

PERMOST UNI FLY



An effective ready to use surface and space treatment (Fog or ULV) for flying and crawling insects offering rapid knockdown. For use against flies, mosquitoes, moths, wasps, ants, cockroaches, earwigs, bristletails, fleas, beetles, mites, ticks and lice. Contains Permethrin and Tetramethrin with Piperonyl Butoxide as a synergist.

For application as space or surface treatment to hard porous and non-porous surfaces. Space treatment: applied through a fogging machine at a rate of 1 ml of product per cubic metre.

Surface treatment: applied through a hand sprayer or boom and nozzle sprayer apparatus as a medium or coarse spray. An application rate of 10 ml/ m².

1 x 5 Litre

ORDER CODE: BPERRTU

£28.21

The new approach

to protecting absorbent surfaces



Suspension concentrate



Most of the Active Ingredient falls into the cracks of the surface.

PARTIX™



The Active Ingredient is incorporated into large, solid particles to stay on top.



K-Othrine®
PARTIX™

 @BayerPestUK

pestsolutions@bayer.com | 00800 1214 9451 | www.es.bayer.co.uk

USE BIOCIDES SAFELY AND SUSTAINABLY. ALWAYS READ THE LABEL AND PRODUCT INFORMATION BEFORE USE. PAY ATTENTION TO THE RISK INDICATIONS AND FOLLOW THE SAFETY PRECAUTIONS ON THE LABEL. K-Othrine® Partix™ is a suspension concentrate containing 2.49% (2.45% pure) Deltamethrin, with broad spectrum insecticidal activity. K-Othrine® Partix™ can be used indoors in domestic, commercial and industrial premises to control crawling insects (including cockroaches and bedbugs), house flies at rest and spiders and for the outdoor control of wasps in free hanging nests. © Copyright of Bayer 2019 - All rights reserved. Bayer CropScience Ltd, 230 Cambridge Science Park, Milton Road, Cambridge CB4 0WB Tel: 00800 1214 9451 www.es.bayer.co.uk

FICAM D

IR



A ready to use odourless insecticide dust for the control of ants, wasps and hornets (nests), including Asian Hornets. Active ingredient is Bendiocarb (1.25 %). FICAM D is particularly recommended for the treatment of inaccessible areas such as roof voids and service ducts where spraying is impractical and around electrical installations where spraying is undesirable. FICAM D is for use indoors.

Standard outer 4.

Approval no. UK 2018-1136

1 x 3 Kg

ORDER CODE: BFICD008

£35.74

CYTROL FORTE WP JAR OR SACHETS



CYTROL FORTE WP JAR

Contains 40 % (w/w) Cypermethrin in a 250 g pot with a measuring scoop. The standard rate of use is 10 g product diluted in 5 litres water. Standard outer 24

CYTROL FORTE SACHETS

Contains 40 % (w/w) Cypermethrin. Available both in handy 10g soluble sachets. The product can be applied by a standard compression sprayer. Standard outer 6

1 x 250 g Jar

ORDER CODE: BCYTRFJR

£78.21

10 x 10 g Sachets

ORDER CODE: BCYTRFOR

£48.69

VULCAN P5



Formulated as a dust for use in voids or around electrical installations where liquid sprays may not be appropriate. For the general control of crawling or resting insects, it can be applied by hand or powered dusters and offers excellent wasp control.

1 x 4 Kg

ORDER CODE: BVULDP4K

£29.23

NEW

DEADLINE PYDUST



For the control of flying and crawling insects such as flies, mosquitoes, ants, cockroaches, wasps, silverfish, fleas, beetles, woodlice, carpet beetle and moths such as clothes moths in public hygiene and domestic situations. Broad-spectrum dust product, ideal for use both internally and externally when controlling insect infestation. Can be applied using a handheld or motorised duster. The formulation provides superior control of flying and crawling insects whilst minimising environmental hazard impact. An ideal product for treating wasp nests externally.

FOR PROFESSIONAL USE ONLY.

Read the label fully before use and carefully follow the instructions. Use only as part of an Integrated Pest Management System.

1 x 3 Kg

ORDER CODE: BPYDUST3

£25.99

PESTICIDE FREE

INSECT control

PRODUCTS

INSECT CONTROL - PESTICIDE FREE

OA2KI® CONCENTRATE



Oa2Ki® Concentrate is a novel polymer technology formulation combined with a water-based delivery system and functions solely by physical means as a liquid sticky trap. Oa2ki® is pesticide-free and is effective in suppressing most types of common flying and crawling insects such as ants, cockroaches, flies, fleas, wasps, and stored product insects.



1 x 500 ml	ORDER CODE: BOA2KI.5	£30.60
6 x 500 ml	ORDER CODE: BOA2KIBP	£149.56

OA2KI® POWDER



Oa2Ki powder is produced from fossilised diatoms (Diatomaceous Earth). The powder is able to desiccate most areas where it is applied. Oa2Ki powder can be applied as dust up to 10 to 30 g/m² of hard surface. Do not breathe powder and wear a mask (P2 filter DIN EN 143).
 • 400 g Puffer Pack • 4 Kg Bucket • 25 Kg Bag.



1 x 400 g	ORDER CODE: BDIAM500	£7.80
1 x 4 Kg	ORDER CODE: BDIAM4KG	£17.95
1 x 25 Kg	ORDER CODE: BDIAM020	£40.17

OA2KI® READY TO USE



Oa2Ki® Ready to Use is the ideal product to use or leave behind with your customer as a backup. For example, if you've just treated for ants, fleas or bed bugs, you can leave this behind so the customer can suppress any stragglers that are still appearing, thus reducing call-backs.



6 x 500 ml	ORDER CODE: BOA2KITRI	£30.60
------------	-----------------------	--------

OA2KI® AEROSOL (POLYMER LIQUID)



The latest addition to the Oa2Ki® insecticide free range: A highly effective knockdown spray for crawling and flying insects. Contains a cellulose polymer effective in rapidly immobilising the insect once sprayed. There is no residual action of this spray, which makes it ideal for sensitive accounts and an ideal sell-on to customers following a bed bug treatment to tackle any remaining insects.



6 x 400 ml	ORDER CODE: BOA2KPOL	£30.20
------------	----------------------	--------

ANTS



FLEAS



BED BUGS



FLIES



POULTRY RED MITE



Oa2ki®

IMPROVED FORMULA

FAST KNOCKDOWN FOR CRAWLING & FLYING INSECTS

Available in four formulations

Product attributes vary within the Oa2ki® brand.
Please read the label for scope and usage.

FOR USE WITHIN
KITCHENS



FOR USE WITHIN
BEDROOMS & BEDS



FOR USE WITHIN
BATHROOMS



FOR USE WITHIN
CRACKS & CREVICES



Barrettine
Environmental Health

USE BIOCIDES SAFELY. ALWAYS READ THE LABEL
AND PRODUCT INFORMATION BEFORE USE.

Unit 4 Caxton Business Park, Crown Way, Warmley, Bristol BS30 8XJ.
Tel: 0117 967 2222 Fax: 0117 961 4122 Email: beh@barrettine.co.uk www.barrettine.co.uk

PESTICIDE FREE

INSECT control

PRODUCTS

INSECT CONTROL - PESTICIDE FREE

OA2KI® AEROSOL (SILICON DIOXIDE)



Very effective in controlling insects by desiccation- apply a light dust to cracks and crevices to insect harbourage areas. Ideal for direct spray application onto vertical surfaces, and under the bed and in crevices where bedbugs are harbouring.

1 x 500 ml

ORDER CODE: BOA2KIAR

£16.49

MITEMAX®



MiteMax® is highly effective against poultry red mite (*Dermanyssus gallinae*). MiteMax® is a patented formulation that has been optimised to penetrate the dusty layers typically found within hen houses and grain stores to spread deep into the cracks and crevices that harbour mites.

MiteMax® contains an advanced food-grade cellulose polymer that acts on-contact with the mite. MiteMax® functions as a sticky trap rendering mites irreversibly immobile providing rapid knockdown. MiteMax® has a physical mode of action by trapping and the death/ killing effect is the consequence of this, which means it both falls outside the scope of the biocide directive (exempted from EU Reg. 528/2013) and also is effective against mites resistant to chemical insecticides.

1 x 500 ml

ORDER CODE: BMITE500M

£30.60

SIRIUS



A physical pesticide for use on a wide variety of insect pests in crops and fields. Application Rates: 250 ml to 1litre/ha.

1 x 1 Litre

ORDER CODE: BSIRI1LT

£64.85

AQUATAIN AMF



Aquatain AMF is a unique silicone-based liquid for mosquito control. Aquatain is applied to the surface of standing water - even large water bodies and forms a very thin film that rapidly spreads across the water. As silicones have a very low surface tension, the film prevents pupae and larvae from attaching themselves at the surface, resulting in rapid death of larvae and pupae as the insect's respiration is affected. Effective for up to four weeks. Apply 1 ml of Aquatain per square metre of water.

Standard outer 6

1 x 1 Litre

ORDER CODE: BAQUA1LT

£POA

NEW

MAXFORCE PUSHBOX



Maxforce Pushbox is a ready to use insecticidal bait station containing 0.03% Imidacloprid, for the rapid control of a variety of ant species indoors and outdoors. Maxforce Pushbox is a colourless, highly viscous gel bait, which contains a food-based formula which is particularly palatable to ants. Maxforce Pushbox also contains the bittering agent Bitrex to prevent accidental ingestion.

- Highly palatable Maxforce™ Quantum formulation
- Controls all major ant species including Pharaoh, Argentine & Ghost ants
- Formulated for nest eradication
- Suitable for indoor and outdoor use
- Convenient, discreet, long term control

20 x 2 g

ORDER CODE: BMAXPUSH

£34.80

MAXFORCE® QUANTUM

IR



Contains 0.03 % Imidacloprid for the control of Black/garden (2-3 weeks), Pharaoh (1-2 weeks), Argentine and Ghost ants. Exclusive Bayer bait matrix for attract-ability and durability in use. Recommended to apply via a B & G applicator gun. Remains attractive for up to three months (Non drying formulation). One 30 g cartridge will treat 150m2 (approx 15 apartments). IR(95547)

Standard outer 10



1 x 30 g

ORDER CODE: BMAXQU30

£46.67

4 x 30 g

ORDER CODE: BMAXQUAN

£174.41

FORMIDOR®



Contains 0.05 % (w/w) Fipronil, Formidor is a highly effective ant bait for complete colony control. Based on fipronil its honeydew formulation is very active at low dose by both contact and ingestion. Quick and easy to use both indoors and outdoors.

Standard outer 4

1 x 25 ml

ORDER CODE: BFORMI25

£33.42

BIOPREN BMS



Containing the insect growth regulator S-Methoprene (0.5 %). Biopren BMS acts by preventing reproduction and blocking growth of larvae in Pharaoh's ant colonies. This granular bait formulation is contained in a ready-to-use container with a food attractant, which can simply be cut open and stuck to a suitable surface.

12 x 2.5 g

ORDER CODE: BBIOPBMS

£44.88

The multi-talented *cockroach gel*



- ✓ *Remains active and effective for up to 12 months*
- ✓ *Contains BlueBead taste enhancing technology*
- ✓ *100% new formulation*
- ✓ *Consistent in all temperatures*
- ✓ *New active ingredient*
- ✓ *Controls cockroaches and grey silverfish*



Maxforce[®]
PLATIN

Together, we protect public health

Contact the Pest Solutions Team at pestsolutions@bayer.com or on **00800 1214 9451**

USE BIOCIDES SAFELY AND SUSTAINABLY. ALWAYS READ THE LABEL AND PRODUCT INFORMATION BEFORE USE. PAY ATTENTION TO THE RISK INDICATIONS AND FOLLOW THE SAFETY PRECAUTIONS ON THE LABEL.

Maxforce® Platin™ is a ready to use insecticidal gel bait containing 1.026% (1.0% pure) Clothianidin UK-2019-1216-001, IE/BPA 70689-001.

Maxforce® Platin™ is a Registered Trade Mark of Bayer © Copyright of Bayer 2020 - All rights reserved. Bayer CropScience Ltd, 230 Cambridge Science Park, Milton Road, Cambridge CB4 0WB
Tel: 00800 1214 9451 www.es.bayer.co.uk

All information contained herein was deemed correct at time of print. Published January 2020. © Bayer Crop Science Ltd

MAXFORCE® PLATIN



Maxforce® Platin has been developed to aid pest controllers foster healthier environments where people live, work and play. Key features and benefits: Remains active and effective for up to 12 months. Contains BlueBead taste-enhancing technology. 100 % new formulation. Consistent in all temperatures. New active ingredient. Controls cockroaches and grey silverfish. Maxforce® Platin is Hypoallergenic and perfect for sensitive environments. The new active ingredient Clothianidin, alongside a new BlueBead feeding stimulant, tackles this problem head-on to give pest controllers a unique tool in combating cockroaches and grey silverfish.

4 x 30 g

ORDER CODE: BMAXPLAT

£82.42

GOLIATH® GEL IR



Contains 0.05 % Fipronil. A ready to use insecticidal gel bait for indoor control of cockroaches. Fipronil based products have a potent effect on target species & are not classified under E.C. regulations based on it's toxicity. IR(94727) 1 cartridge = 1660 spots

Standard outer 5

4 x 35 g

ORDER CODE: BGOLI.35

£203.16



Goliath® Gel



Commercial kitchens



Warehouse



CONFIDENT
FOR
21
YEARS



House kitchen



Food industry



Bakery



2000 // 2021

Thank you for over two decades of confidence! During this time, Goliath Gel offered :

- Great efficacy due to an extremely palatable bait formulation and its cascade effect
- Its micro-dose rate allows to achieve a very cost-effective solution

Goliath Gel, copied but never equalled.

Use insecticides safely. Always read the label and the product information before use. Goliath Gel is a registered BASF trademark. Goliath Gel contains fipronil.



SMOKE GENERATORS

INSECT control

PRODUCTS

Save time, place your order any time.

PAY ONLINE

BarrettineEnv.co.uk



USER FRIENDLY



EASY TO SIGN UP



LATEST PRODUCTS & PROMOTIONS



COOPEX MAXI SMOKE GENERATORS

IR



Contains 13.5 % (w/w) Permethrin. Each generator treats up to 1,000 m³ (approx. 35,310 cu.ft.) Kills insects exposed at time of treatment. (Requires PA1 and PA9 certificate for use in agricultural applications). IR(93409)

Standard outer 6

1 x 12

ORDER CODE: BCOMAXSG

£154.69

COOPEX MINI SMOKE GENERATORS

IR



Contains 13.5 % (w/w) Permethrin. Each generator treats up to 120 m³ (4,250 cu.ft.) Kills insects exposed at time of treatment. IR(93408)

Standard outer 6

1 x 35

ORDER CODE: BCOMINSG

£143.14

FORTEFOG JUMBO FUMER



Contains Permethrin. The Fortefog Jumbo Fumer has been designed for those really big jobs on the farm or in warehouses. One fumer will treat up to 4000 cubic metres.

Standard outer 4

Each 100 g

ORDER CODE: BFORTJUM

£26.31

INSECT CONTROL - SMOKE GENERATORS

AEROSOLS

INSECT control

PRODUCTS

BAYER® FLYING INSECT KILLER



Bayer Flying Insect Killer contains D-Tetramethrin 0.15 % (w/w) and D-Phenothrin 0.15 % (w/w) for Flying insect control. Can also be used for controlling ants, bed bugs, cockroaches and fleas.

BUY 3 GET 1 FREE
25% OFF

12 x 400 ml

ORDER CODE: BPRCOFLY

£71.66

WASP NEST DESTROYER FOAM



The Wasp Nest Destroyer Foam is designed to exterminate wasps within their nest from a two-metre distance. Use this product when entire nests are visible in a loft, shed, garage, tree etc. Do not use for underground nests. This fast-acting product contains D-Phenothrin and Tetramethrin and is effective within 24 Hours.

1 x 300 ml

ORDER CODE: BDEADWAS

£3.74

DETHLAC INSECTICIDAL LACQUER



Active ingredient 0.02 % (w/w) Deltamethrin & natural pyrethrums. Dethlac insecticidal lacquer kills ants, cockroaches, woodlice and other crawling insects. May be applied to any firm non-absorbent surface for both indoor and outdoor use. Dries to a hard clear film & one application remains active for months even when it rains or if the surface is washed. Approved for both amateur and professional use.

12 x 250 ml

ORDER CODE: BDEAE.25

£37.47

ACCLAIM 2000



Contains 0.018 % Methoprene and 0.567 % (w/w) Permethrin for control of fleas. When applied as a fine mist to pet bedding, carpets and soft furnishings can give continuous protection for seven months.

Amateur use. 1 x 500 ml treats up to 140 m².

1 x 500 ml

ORDER CODE: BACCLAIM

£22.02

NEW

CIMETROL SUPER RTU



Cimetro Super RTU is a professional ready for use, water-based spray to control bedbugs, fleas and other crawling and flying insects. Approved for use on mattresses and soft furnishings, the unique 300ml bottle delivers a fine and continuous spray at any angle and even upside down.

Standard outer 12.

1 x 300 ml

ORDER CODE: BCIMERTU

£8.95

PROTECTOR 1 SHOT



Contains 0.25 % (w/w) Pyrethrins. Water-based aerosol with special lock nozzle enabling the spray to be used as a full release aerosol. An ideal alternative to smoke generators, e.g. cluster flies in a loft, offering a rapid knockdown.

Organic option.

1 x 530 ml

ORDER CODE: BPRISHEA

£9.52

12 x 530 ml

ORDER CODE: BPRISHBU

£100.14

PROTECTOR NATURAL



Contains 0.25 % (w/w) Pyrethrins. 100% natural active ingredients. Water-based aerosol with no solvent smell. Rapid knockdown activity against a wide range of pests. Amateur use approval.

12 x 530 ml

ORDER CODE: BFORTFOG

£95.87

PREVENT SPRAY



Contains 1.0 % (w/w) Pyrethrins & 5.0 % (w/w) Piperonyl Butoxide. A compact personal insecticide and insect repellent, particularly useful to environmental health officers and pest control officers who, on a daily basis visit infected premises.

1 x 25 ml
Prevent Spray

ORDER CODE: BPREVENT

£5.14

24 x 25 ml
Prevent Spray

ORDER CODE: BPREVBUL

£110.13

1 x 250 ml
Prevent Auto Can

ORDER CODE: BSWAKIEA

£7.37

INSECT/MICE TRAPS

INSECT control

PRODUCTS

MoBe® MOAT



MoBe® Moat has been designed and successfully used by professional pest controllers in conjunction with some of the industries leading food manufacturers.

The MoBe® Moat consists of 18 metres of siliconised paper with adhesive applied to one surface and has been manufactured as an aid to trapping mice and insects around problem, high-risk areas. In addition to physically trapping pests, the strip is wide enough to act as a barrier to help prevent mice or insects from crossing over. The paper comes with pre-printed hazard warning lines so to warn others of the tape as well as usage instructions. The tape can be cut to the desired length giving a great number of potential applications. If trapping/monitoring insect pests, additional lures can be added along the tape's length.

Primarily the MoBe® Moat has been designed as a 'quarantine' barrier working in two ways:

- To stop potential movement by pests into previously infestation-free areas/products
- To cordon off known infested areas or products to prevent the spread of an infestation.

Some of the many potential applications:

- 1) To quarantine contaminated pallets of product and prevent cross-contamination to other stock, e.g. peanuts, rice, pet food.
- 2) To act as a barrier to known clean products, e.g. post fumigation commodities or finished product awaiting dispatch.
- 3) Using tape to glue the underside, MoBe® Moat can be stuck to the inside of silos to prevent migration of grain pests.
- 4) Act as a single large overnight trap in sensitive infested areas e.g. around the perimeter of commercial kitchens against cockroaches.

Please be aware the start of the roll contains no glue.

Standard outer 15

Please note that whilst the glue has been designed and tested successfully against both mice and insects, as with other similar devices, we cannot guarantee that it will successfully retain all pests under all environments and conditions. When using primarily against mice, it should be seen as an aid to protecting goods rather than the only method of control or monitoring. Always use in accordance with the Pest Management Alliance Glue Boards guidelines. The MoBe® Moat is sold as a professional only product.

1 x 18 m

ORDER CODE: BMOBMOAT

£28.83

ROMAX® INSECT 'FLOOR' CLEAR & BLACK

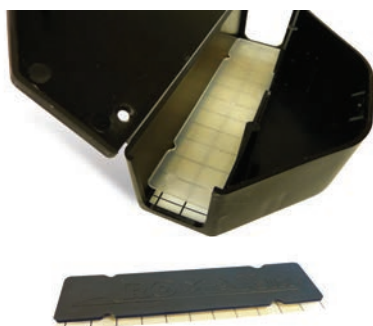

An insert to convert the award-winning Romax® mouse box, into a convenient and cost-effective insect monitor. The clear design allows easy identification at a glance to determine if there are any (larger) insects on the pad below.

1 x 10
Clear

ORDER CODE: BBBROMFC

£4.28

1 x 10
Black

ORDER CODE: BBBROMFL

£5.28

ROMAX® GLUE SOLVENT



A responsible and essential component of a Pest Technicians toolbox, the Romax® Glue Solvent solubilises the non-drying glue. This is ideal for removing insects from the Romax® Glue Boards for identification and cleaning hands or surfaces covered in glue. It is also key in the responsible use of glue boards and traps to release non-target pests quickly.

1 x 50 ml

ORDER CODE: BMOBGLUS

£7.76

MoBe[®] Moat

A Multi-purpose Adhesive Barrier

For temporary quarantine, pest monitoring and product protection.

Protects against
Rodents & Crawling Insects



KEY FEATURES:

- /// Isolate suspected and infested products.
- /// Ideal for use as a temporary monitor trap & entry barrier.
- /// Chemical free protection for food storage, production & handling materials.
- /// Special non-dry glue technology - stays sticky for long periods.
- /// 18 metres on every roll - special siliconised paper.
- /// Easy to tape down for greater security.



Attach food or pheromone lures to attract target pests.



MoBe Moat can be cut to fit any situation.

INSECT/MICE TRAPS

INSECT
control
PRODUCTS

PLASTIC INSECT MONITOR

Insect monitor for either standalone use or with the Quicklock Microbait - the monitor can house the Pre-Baited Replacement glue pads below.



1 x 10

ORDER CODE: BTRQLINB

£39.53

PRE-BAITED REPLACEMENT GLUE PADS

Pre-baited glue pads for use in reusable plastic insect detectors such as the "Plastic insect monitor" (above) or similar trap.



Standard outer 20

1 x 100

ORDER CODE: BTRPBRGB

£19.24

INSECT
control
PRODUCTS

BED BUG TRAPS & TREATMENTS

TRAPPIT BB DETECTOR



Agrisense have developed and refined a formulation that has resulted in a trap that is both sensitive and efficient in trapping and monitoring both the instar developmental stages as well as adult Bed Bugs. The trap allows effective and discreet monitoring of the presence of Bed Bugs, and when used with the lure the catch rate is greatly improved.

(Lure not included).

2 x 10

ORDER CODE: BTRBBMON

£9.87

TRAPPIT BB DETECTOR PLUS



The Agrisense bed bug lure significantly improves the catch rate when used with the trap. Excellent detection of Bed Bug nymphs.

(Includes trap and lure).

2 x 10

ORDER CODE: BTRBBLUR

£56.92

CIMEX ERADICATOR STEAMER



The Eradicator is the latest solution for the elimination of bed bugs. Lab and field tests show that the flow of superheated steam generated by the unit can eliminate 100 % of the eggs and an extremely significant proportion of the mobile stages in a single pass. Dimensions (included wheels): 36 x 42 cm. Easily portable at just: 4.9 Kg.

Each

ORDER CODE: BCIMERAD

£569.23

REPLACEMENT HP MED

1 x 50 ml

ORDER CODE: BCIMEHPM

£12.81

REPLACEMENT KALSTOP

1 x 2 ml

ORDER CODE: BCIMEKAL

£0.69

CLEANBRANDS MATTRESS COVERS



10 YEAR WARRANTY

The pre-emptive CleanRest Pro is waterproof, allergen-impermeable, fully breathable fabric giving maximum sleeping comfort. This encasement will significantly reduce your treatment costs and keep Bed Bugs away from mattresses. Enquire for sizes and pillow options.

Single

ORDER CODE: BMATCOVS

£24.49

Double

ORDER CODE: BMATCOVD

£30.47

King

ORDER CODE: BMATCOVK

£32.48

Super King

ORDER CODE: BMATCOSK

£39.70

WATER SOLUBLE BAGS



Water-soluble bags are designed to hold any contaminated clothing or linen so they can be transferred from point of infestation without the risk of transfer. The water-soluble bags will dissolve in water, so there is no need to remove contaminated clothing or linen before placing in a washing machine. All bed bug life stages are killed when treated in a 60°C wash cycle.

1 x 25

ORDER CODE: BSOLBAGS

£POA

COCKROACH TRAPS

TRAPPIT CR LO-LINE RTU



Research proves that the Lo-line is one of the most effective cockroach traps on the market. The insects are drawn to the trap by the odours, climb in, over the specially angled ramps and are held fast on the glue floor. The Lo-Line has a large sticky floor area allowing many insects to be caught before replacement is necessary. Lo-line has now been reformulated to utilise a specific food lure within the glue (rather than just a flavouring used in many other traps).

Standard outer 20

1 x 10

ORDER CODE: BTRTRLLR

£5.94

TRAPPIT CR CORNER RTU



A smaller size detector for detection and location of cockroaches and other crawling insects. Detector traps have now been reformulated to utilise a specific food lure within the glue (rather than just a flavouring used in many other traps).

Standard outer 20

1 x 30

ORDER CODE: BTRINMON

£8.78

TRAPPER MONITOR & INSECT TRAP



Each is perforated to be split into 1/3 rd size. The underside has a self-adhesive strip. Every pack comes with 300 cockroach lures and is now blank, thus enabling more discreet positioning of the product.

Bell Products are imported from America, therefore exposed to currency exchange rate fluctuation. Please call our Sales team to confirm prices.

Standard outer 12

1 x 300

ORDER CODE: BTRMONIN

£56.92



Mint Members enjoy
UP TO
20% OFF
PLUS PROMOTIONAL SAVINGS

TRAPPIT
CR Range

The Detectives



If you think you have a cockroach problem forget about calling Kojak, Columbo or Quincy. You need the real detectors Trappit Lo-line, Winged and Corner from Agrisense.

They will do all the dirty work for you. With their dry touch glue and food grade attractant, they are ready to lure in any nuisance cockroaches in your neighbourhood.



WASP
SPIDER
COCKROACH
MOTH
BEETLE
ANT

Find out more at
www.agrisense.co.uk

AGRISENSE

a Pelsis Group Brand  **pelsis**

ANT STATIONS

'ANT-CAFE' BAIT FEEDING STATIONS



These excellent feeding stations are ideal for use with insecticide baits and gels. The triangular station can be placed and secured out of children and pets' reach whilst targeting specific areas to be treated. Please note these stations are supplied empty and are used in conjunction with insecticide baits and gels.

1 x 30

ORDER CODE: BANTCA30

£5.30

GEL CANTEEN



Can be quickly filled with gel baits through the small hole on the top of the station the gel canteen is suitable for applying cockroach and ant gels. The entire station rotates, allowing the user to restrict the size of the opening dependent on species (and prolong the bait life) and completely close the aperture. Please note these stations are supplied empty and are used in conjunction with insecticide baits and gels.

1 x 30

ORDER CODE: BINSGELC

£21.08

TECHNICIANS FIELD GUIDE

A complete and essential guide for the professional.

The Barretttine's pocket-size A6 Pest Technicians guide contains detailed information to assist in the daily routine of a Professional Pest Control Operator: A 'how to' guide covering topics of insect and rodent information and identification, equipment calibration, non-chemical insect control measures, pesticide application and product safety, dealing with waste: Triple rinsing as well as detailed information on LD₅₀.

PRICE: £23.03
ORDER CODE: BPIDBOOK



FLYING INSECTS

CRAWLING INSECTS

SPI, AGRICULTURE & AMENITY PESTS

RODENT PESTS

BIRD PESTS

TRAPPIT WASP BAG



Effective, safe and easy to use. Each trap has a generic print, with instructions for use in six languages. For the wasp bag, use 500 ml of ready to use wasp bait (sold separately, see below) and hang. Once the trap is full of dead insects, close the screw cap and dispose of in household waste.

Standard outer 25

Each

ORDER CODE: BTRWASPB

£2.81

TRAPPIT LIQUID WASP BAIT



Just add water: a single trap can catch and kill up to 20,000 flies. For outdoor use, ideal for farms, stables, gardens and around bins and refuse areas. Clean and easy disposal.

1 Litre - Standard outer 4
5 Litre - Standard outer 2

1 x 1 Litre

ORDER CODE: BTRDWFL1

£11.11

1 x 5 Litre

ORDER CODE: BTRDWFL5

£39.83

TRAPPIT WASP DOME



Wasp Dome Trap: the original wasp trap developed over 30 years ago. Tried, tested, reliable and reusable. To be used with the Trappit liquid wasp bait. Available individually or in packs of 40.

BUY 4 GET 1 FREE
20% OFF

Each

ORDER CODE: BTRDOMNL

£6.50

NEW

VESPULURE WASP BAIT



A highly effective monitoring liquid to be placed within wasp monitoring traps to monitor the presence of wasps and hornets, including Asian hornets (*Vespa velutina*). The use of the Vespure monitoring liquid can draw wasps away from areas and can also be used as an effective feeding station to identify the location of wasp and hornet nests for areas that subsequently, need to be cleared of these stinging insects.

The monitoring liquid is formulated with carbohydrates and volatile solvents that assist in expanding of the monitoring area. The formulation contains a bee repellent.

1 x 5 Litre

ORDER CODE: BVESPUL5

£36.75

FLY TRAPS

INSECT CONTROL - FLY TRAPS

TRAPPIT FLY BAG



Disposable outdoor fly trapping system for use in any location with a high fly population. Water-soluble fly bait is contained within the bag - just add water! Highly effective with a capacity for thousands of flies when full, close the cap and dispose of in normal waste.

Standard outer 25

Each	ORDER CODE: BTRFLYBG	£3.19
------	----------------------	-------

FLY TRAP



Just add water: a single trap can catch and kill up to 20,000 flies. For outdoor use, ideal for farms, stables, gardens and around bins and refuse areas - clean and easy disposal.

BUY 4 GET 1 FREE
20% OFF

Each	ORDER CODE: BTRFL332	£6.42
------	----------------------	-------

REDTOP FLY TRAP



A highly effective, easy to use, non-toxic outdoor fly trap. Each trap can potentially catch up to 20,000 flies. The bait that is included with the trap is especially appealing to female flies, thus breaking down the breeding cycle. Bait lasts for up to 12 weeks.

BUY 4 GET 1 FREE
20% OFF

Each	ORDER CODE: BTRREDFT	£9.80
------	----------------------	-------

TRAPPIT FRUIT FLY LEMONS



A ready to use fruit fly trap that dramatically reduces fly populations by using a sweet smelling lure to attract the flies. Very safe, can be used in homes, pubs, cafes, restaurants etc.

1 x 12	ORDER CODE: BTRFRNFL	£23.82
--------	----------------------	--------

YELLOW STICKY TRAPS



Coated both sides with non-drying / non-drip insect glue and water-resistant. Yellow sticky traps are effective for Whiteflies, Aphids and Sciarids. Medium Yellow Sticky Trap 4 x 8 inches (One hole) with green ties - Flow wrapped in clear film in 10's.

1 x 10

ORDER CODE: BTRYELST

£3.07

STICKY FLY CATCHERS



Made from natural products, these are non-toxic sticky flycatchers coated with a special fly attractant. A useful aid where minimal or no insecticide is allowed. Also an ideal product to leave with your customer.

Each

ORDER CODE: BAFLYCAT

£1.54

BARN & STABLE FLY CATCHER



Sticky roll trap with integrated pheromone lure. Large Trapping Area - 10sq.ft. Insecticides free and odourless.

Each

ORDER CODE: BABARNST

£13.65

STANDARD FLY MESH ROLL

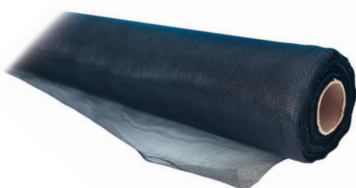

A 1.2 m wide x 30.5 m long fly mesh. Make up your own fly screens.

Per roll

ORDER CODE: BSTDFLME

£81.96

STORED PRODUCT INSECT TRAPS

INSECT
control
PRODUCTS

TRAPPIT BEETLE (PITFALL)



An easy to use continuous insect monitor for use in stored cereals, pulses and feedstuffs. It is used to detect mites, weevils and beetles.

Standard outer 6

1 x 10

ORDER CODE: BTRPITFA

£48.57

GENERAL GRAIN BEETLE ATTRACTANT



The lure has been formulated to be particularly effective in attracting: *Sitophilus granarius* (grain weevil, wheat weevil, or granary weevil) a serious pest of oats wheat, barley, rye, corn and rice. *Sitophilus oryzae* (lesser grain weevil or rice weevil) pests of stored cereals such as barley, maize, rice and wheat, split peas and pasta. *Oryzaephilus surinamensis* (saw-toothed grain beetle) a pest of damaged cereal grains.

1 x 10

ORDER CODE: BGRBTATT

£23.00

TRAPPIT EASISSET DELTA



A stored product moth trap. A kit consists of one trap plus ten sticky inserts. Plastic construction for use in non-dusty areas. Insects are caught on a replaceable sticky insert. See chart for available lures on page 34.

1 x Kit

ORDER CODE: BTRDELTA

£9.39

EASISSET DELTA STICKY INSERTS

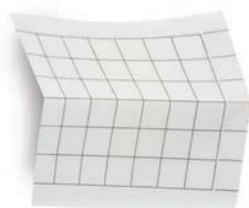

Replaceable cardboard sticky liner for the delta trap.

1 x 10

ORDER CODE: BTRDESTI

£6.16

TRAPPIT SPM LOCATOR

A low profile trap for detection of stored product moths in difficult access areas. Twenty dispensers and twenty sticky traps.

Standard outer 10

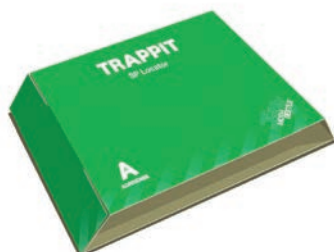

10 x 2

ORDER CODE: BTRSPLOC

£16.26

TRAPPIT SPM BLACK STRIPE FUNNEL KIT

A stored product moth trap (includes four Ephestia / Plodia lures). Robust plastic construction for use in dusty areas. Other lures may also be used with this trap.

Standard outer 16
(Bulk pack does not include lures)



Each

ORDER CODE: BTRFUMOT

£14.23

1 x 50
Bulk Pack

ORDER CODE: BTRFUMOB

£439.65

FUNNEL TRAP LURE HOLDERS & STICKY INSERTS

For use with Trappit SPM Black Stripe moth trap.

Lure holders - Standard outer 5
Sticky inserts - Standard outer 10

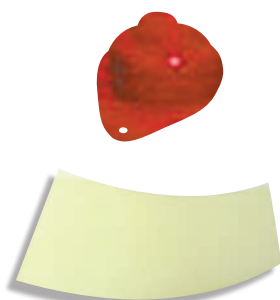

1 x 10
Lure Holders

ORDER CODE: BTRFLCAP

£4.68

1 x 10
Sticky Inserts

ORDER CODE: BTRFUSTR

£11.93

ENTRAP - GRAIN STORE INSECT MONITOR

For use in empty grain stores to monitor insect levels. Easy to assemble sticky trap with luring agent - lure contains no grain or nuts.



1 x 4
Traps & Lures

ORDER CODE: BENTRAPS

£9.92

CLOTHES MOTH TRAPS

INSECTRAC CL PHEROMONE & DISPENSER



Insectrac CL Tab is a unique, pesticide-free, pheromone-based monitoring trap for clothes moth. Using Entostat powder, combined with the pheromone specific to the female clothes moth (*Tineola bisselliella*) to create an intelligent and pesticide-free system for use on clothes moth.

The Insectrac CL Tablet Dispenser is designed specifically for the CL tab for discreet application in homes, museums etc.

1 x 24 Tablets	ORDER CODE: BEXOSCLT	£179.61
1 x 24 Dispenser	ORDER CODE: BEXOCLPD	£51.53

TRAPPIT WCM BLACK STRIPE DELTA KIT



Tineola bisselliella, more commonly known as the Clothes Moth, is the most important moth pest of natural fabric materials. This trap and lure make it possible to have an early warning system for the pest.

Standard outer 10

1 x 10	ORDER CODE: BTRCLOTH	£31.31
--------	----------------------	--------

NEW

CL TRAC PRE-BAITED CLOTHES MOTH & HOLDER



CL-Trac Clothes moth holder and lure – Highly effective monitoring of clothes moth infestations and necessary when natural materials such as woollen clothing, upholstery and carpets, as well as other animal-based material, such as silk, hair or fur need to be monitored. Pheromone lure has an optimised release rate over a 12 week duration.

CLOTHES MOTH KIT (10 holders and lures)

1 x 10	ORDER CODE: BLPBCLOT	£15.50
--------	----------------------	--------

REPLACEMENT LURE PADS (10 glue pads and pheromone lure)

1 x 10	ORDER CODE: BLPBLURE	£6.25
--------	----------------------	-------

RENTOKIL CLOTHES MOTH KILLER PAPERS



Contains transluthrin. Kills moths, their larvae and eggs with an odourless insecticide-impregnated on a paper strip. One strip will cover one cubic metre and last up to six months. Each pack has two strips.

1 x 10	ORDER CODE: BREMOKS2	£3.33
--------	----------------------	-------

LURES



Other lures available are on request including Lesser Grain Borer, Carpet Beetle. Call the sales office for details. Minimum order quantity may be required.
All pack sizes: 1 x 10

PRODUCT	ORDER CODE	PRICE
Stored Product Moth <i>Ephestia / Plodia</i>	BLEPPLD	£10.21
Almond Moth <i>Ephestia cautella</i>	BLEPCAUT	£POA
Clothes Moth <i>Tineola bisselliella</i>	BLTINBIS	£11.76

STORED PRODUCT MOTH LURES

January - March



April - June



July - September



October - December



Four coloured lures for Stored Product Moth monitoring and detection. Helps improve pest management practice making change of lures more visible to both technicians and customers alike. Effective for *Ephestia* species and *Plodia interpunctella*.

Lures can be used in any rotation and in any season. All lures will work equally effectively at all times of year. Can be used in all moth monitoring traps such as Funnel Traps, "Easiset" and Black Stripe Delta Traps. Each pheromone dispenser is supplied in labelled and vapour proof sachets.

Please order 5 - 10 working days in advance of required delivery date.

Blue	ORDER CODE: BLSPECBL	£11.04
Green	ORDER CODE: BLSPECGR	£11.04
Red	ORDER CODE: BLSPECRE	£11.04
Yellow	ORDER CODE: BLSPECYL	£11.04

Join our exclusive Mint Membership
it's 100% free.

Register today online or contact our sales office
Email: beh@barrettine.co.uk
www.barrettineEnv.co.uk

AMENITY MOTH LURES



The Pine Processionary (*Thaumetopoea pityocampa*) is a moth of the family *Thaumetopoeidae*. It is an abundant species of pine woods in central and southern Europe, and as such, has been an important economic pest to Forestry. This is increasing concern, especially in more urban areas due to both the severely irritating hairs that protect the caterpillar larvae. The Oak Processionary Moth is an invasive pest relatively new to England, being found in London in 2006. The Oak processionary Moth is a serious health risk to humans and animals, predominantly from the urticating hairs that cause allergic responses and necrosis on the tongues of dogs that come into direct contact with the caterpillars.

Lures and traps are available to monitor Pine and Oak Processionary Moths in high risk areas. In addition, a number of treatment options are available for both Processionary and Brown Tail Moths, contact the office for more information.

1 x 10

ORDER CODE: BLPINEML

£POA

TRAPS & LURE USAGE



MOTH	COMMON NAME	MOBE TRAP	DELTA TRAP	TRAPPIT SPM	CL TRAC
<i>Cameraria ohridella</i>	Chestnut Leaf Miner		■		
<i>Ephestia/Plodia</i>	Stored Produce Moth		■	■	
<i>Ephestia cautella</i>	Almond Moth		■	■	
<i>Ephestia elutella</i>	Warehouse/Tobacco Moth	■	■	■	
<i>Ephestia figulilella</i>	Raisin Moth		■	■	
<i>Ephestia kuhniella</i>	Mediterranean Flour Moth		■	■	
<i>Plodia interpunctella</i>	Indian Meal Moth		■	■	
<i>Sitotroga cerealella</i>	Angoumois Grain Moth		■	■	
<i>Tineola bisselliella</i>	Clothes Moth		■	■	■



BETLES	COMMON NAME	MOBE TRAP	DELTA TRAP	SPM LOCATOR	PC TRAP
* <i>Lasioderma serricorne</i>	Tobacco Beetle	■			
<i>Rhizopertha dominica</i>	Lesser Grain Borer			■	■
<i>Stegobium paniceum</i>	Biscuit Beetle		■	■	■
<i>Tribolium castaneum</i>	Red Rust Flour Beetle			■	
<i>Tribolium confusum</i>	Confused Flour Beetle			■	

* Also consider Serrico traps.

SLUG & SNAIL TRAP

Portable pesticide free slug & snail trap. Unique design allows for easy emptying. The traps come with a specially formulated bait that will attract slugs and snails from a distance of up to two metres away. The attractant lasts for up to 2-3 weeks.



Each	ORDER CODE: BTRSLUGT	£15.41
1 x 100 g Attractant refill	ORDER CODE: BTRSLUGR	£5.82

COPPER SLUG TAPE

Static charge deters the pests from crossing the tape, easy to use just peel paper backing & stick to protect all areas from slugs and snails safe for children & pets.



1 x 4 m	ORDER CODE: BTRSLTAP	£3.31
---------	----------------------	-------

ELECTRIC FLEA TRAP/KILLER

A heat lamp mimics warm-blooded animals to attract fleas from bedding and carpets. Each trap will cover a 10 metre radius. The sticky pad acts as an early indicator of flea infestation and has three replacement pads. Each trap has three replacement pads. Manufactured to meet UK and European safety specifications.



Each	ORDER CODE: BFLEATRA	£18.56
------	----------------------	--------

FLEA TRAP REPLACEMENT KIT

For use with the Electric Flea Trap/Killer (above).
Contains 2 x Bayonet Bulbs & 3 x Pads



Each	ORDER CODE: BFLEATKI	£9.09
------	----------------------	-------

TOBACCO BEETLE & MOTH TRAPS

MoBe® COMBO TRAP Mk.2



The MoBe® Combo Trap Mk.2 monitoring system has been designed specifically for the Tobacco Industry and is based on the latest in pheromone technology. The MoBe® lure is a combined lure that contains the sex pheromone for both the tobacco beetle (*Lasioderma serricorne*) and tobacco moth (*Ephestia elutella*) thus reducing both product and labour costs.

Standard outer 10

1 x 20
Traps

ORDER CODE: BTRMOBET

£60.19

INSECTRAC SP PHEROMONE



Patented Entostat powder technology, causing confusion and disrupts mating amongst target pests. Effective against *Ephestia elutella*, *Ephestia kuehniella*, *Ephestia figulilella*, *Cadra cautella* & *Plodia interpunctella*.

1 x 24

ORDER CODE: BEXOSSPT

£179.61

INSECTRAC SP PHEROMONE DISPENSER



Specially designed dispenser, in food environment 'blue' and metal-detectable for use with the SP tab.

1 x 24

ORDER CODE: BEXOSPPD

£51.53

SERRICO TRAPS



Folded carton board trap lined with contact adhesive. Attracts Tobacco Beetle through placement on the trap of a food attractant and the Female Sex Pheromone. Each pack contains 10 traps, Pheromone/Food Lures. (One year shelf life).

Standard outer 20

1 x 10

ORDER CODE: BTRSERIC

£55.53

NEPOREX



A larvicide containing the insect growth regulator (IGR) Cyromazine. Ideal for use in a wide variety of applications to prevent larvae from developing into flies, giving longer lasting fly control and greater impact on total fly populations. Neporex kills 80% of flies present in manure as larvae and can be used in dairy, calf, poultry, pig units as well as waste management & landfill environments.

PA1 & PA6 license required for use.

1 x 1 Kg

ORDER CODE: BNEPOR1K

£393.73

DEADLINE INSECTABAN



Contains 0.23% (w/w) Permethrin. For the control of insects such as flies, wasps, moths, bed bugs etc. For use in domestic and commercial premises. A versatile product that can be applied as a surface spray, painted onto a surface, or applied as a fog.

Standard outer 2

1 x 5 Litre

ORDER CODE: BFLYI005

£55.17

PYBUTHRIN 33

IR



Contains 0.38 % (w/w) natural pyrethrins synergised with Piperonyl Butoxide. A ready-to-use high volume space spray for the control of flying and crawling insects. It offers rapid knockdown and kill with no residual activity. Pybuthrin 33 can be applied as a coarse spray via a compression sprayer, or as a mist or fog. IR(93411)

Standard outer 4

1 x 5 Litre

ORDER CODE: BPY33005

£68.87

HARMONIX POULTRY RED MITE



A water-soluble concentrate with a physical mode of action effective against poultry red mite (*Dermanyssus gallinae*) for use in and around avian housing. Harmonix Poultry Red Mite will also trap other small crawling insects. It's dust penetrating formulation breaks through to cracks and crevices where mites harbour, controlling mites up to 48 hours faster than some alternative chemical controls. Birds do not need to be removed before application, but eggs should be removed, and birds should not be sprayed directly.

Standard outer 4

1 x 5 Litre

ORDER CODE: BHARRM05

£81.90

RURAL HYGIENE

INSECT control

PRODUCTS

NEW

X-LARV



X-LARV is an innovative product for the treatment of stagnant and still waters to control mosquito larvae. X-LARV acts by physical-mechanical action ensuring efficacy up to 4 weeks and for use in still and stagnant water such as sewers, drains, manholes, saucers, buckets, tires, gutters, water tanks and septic tanks, etc.

X-LARV is a liquid ready to use which, when applied to the surface of the water, quickly creates a thin film that prevents the development of immature stages of mosquitoes (larvae and pupae).

1 x 1 Litre

ORDER CODE: BXLARV1L

£32.00

SORGENE EXTRA



Sorgene Xtra is a broad-spectrum disinfectant, highly effective in farm conditions against bacteria, viruses and fungal spores. Sorgene Xtra has DEFRA approval for three notifiable diseases (foot-and-mouth, poultry orders and general orders) and lower dilution rates, compared to Sorgene 5, on some diseases.

1 x 5 Litre

ORDER CODE: BSORG005

£54.58

RESIDEX P



Residex P Insect Killing Powder is a surface residual dusting powder containing 0.5% Permethrin and is suitable for the control of crawling insects indoors and out. It should only be used in dry conditions and is ideal for dusting into cracks and crevices to control ants, cockroaches, beetles, bed bugs and any other crawling insects. Can also be used in wasps nests.

1 x 300 g

ORDER CODE: BRES13EA

£4.08

12 x 300 g

ORDER CODE: BRESI300

£48.44

We've made it
SUPER EASY

TO ORDER ONLINE

BarrettineEnv.co.uk



AQUAPY & AQUAPY MICRO

IR



Contains 30 g / litre of pyrethrins synergised with 150 g / litre Piperonyl Butoxide. AquaPy is a water-based formulation ideal for space treatments against flies, mosquitoes, moths, tobacco beetles on the wing and other stored product insects. AquaPy micro bottle can attach directly to certain ULV machines, Accepted for Use in Organic areas/sites. (Requires PA1 and PA9 certificate for fogging application within grain stores and agricultural applications). IR (93571).

Standard outer 12

1 x 1 Litre	ORDER CODE: BAQUA001	£95.35
1 x 1 Litre Micro	ORDER CODE: BAQUAMIC	£108.65

GRAIN-TECT® ULV



A ready-to-use treatment for direct application to grain to control insect pests. Can be applied through most existing ULV applicators capable of dosing in the range of 42 ml per tonne. Gives up to 12 months protection - refer to label for application rates. For Professional use to be applied by persons holding the relevant PA certification. (PA1 & PA12) A highly effective formulation containing 6 g/l Deltamethrin and 54 g/l Piperonyl Butoxide.

Barrettine can supply application equipment and installation advice. Contact us now for all your grain-store hygiene requirements.

1 x 20 Litre	ORDER CODE: BKBIO020	£474.58
--------------	----------------------	---------

Grain-Tect ULV

INSECTICIDE FOR CONTROLLING INSECT PESTS IN STORED GRAIN AND PULSES

- ✓ Provides grain with **12 months protection**
- ✓ **6 x longer protection** than spraying an empty store
- ✓ **478 tonnes** treated with just 1 x 20 litre
- ✓ **Simple** - Ready to use formulation

Application rate to grain: 42 ml per tonne via 'twin fluid nozzle' using compressed air to atomise spray droplets. Nozzle must be positioned at a point where it can mist through grain as it falls by gravity through an enclosed duct.

GRAIN STORE HYGIENE

INSECT control

PRODUCTS

INSECT CONTROL - GRAIN STORE HYGIENE

K-OBIOL EC25



Contains 2.5 % (w/w) Deltamethrin synergised with Piperonyl Butoxide. This pyrethroid grain protectant is an ideal alternative to organophosphorus formulations and can be used to treat the fabric of the building pre-harvest, as well as an add-mix to the grain. Unlike other products, there is no withholding period governing use of the grain. K-Obiol is accepted by NABIM and BRI. (Application in empty grain stores requires PA1 and PA6 certificate, application to grain requires PA1 and PA12 certificate).

Standard outer 12

1 x 1 Litre

ORDER CODE: BKOBIOLE

£77.73

ACTELIC 50 EC



Contains 49.02 % (w/w) Pirimiphos-Methyl. An emulsifiable broad-spectrum insecticide concentrate for use in grain protection.

Standard outer 12

1 x 1 Litre

ORDER CODE: BACD50EC

£214.12

ULV APPLICATOR



A simple robust Ultra low volume applicator for use to apply Grain-Tect ULV and K-Obiol formulations to grain. Kit includes pump, nozzle, air and liquid transfer tubing pressure regulator.

Each

ORDER CODE: BULVAPLI

£POA

MINT
EXCLUSIVE MEMBERSHIP



Mint Members enjoy
UP TO
20% OFF
PLUS PROMOTIONAL SAVINGS

Effective weed control is a combination of choosing the most suitable product and getting the application right in terms of timing, dose rate and application technique. Professional products are powerful chemicals which if misused, can damage non-target plants and potentially contaminate, for example, watercourses, therefore herbicides must only be applied by operators who hold the appropriate pest application certificates (PA1 & PA6). PA1 is the foundation qualification required by all spray operators and then they will also need the certificate relevant to the specific spray equipment they will be using, for example, a PA6 for applications made using a knapsack sprayer.

Terminology used to describe herbicides:

TOTAL	Refers to products that are non selective and within reason will control all vegetation.
SELECTIVE	Most commonly identifies products that control broad leaved weeds without harming turf/grass.
TRANS-LOCATED	Products that, subject to growing conditions, are absorbed by the plant and move within the plant tissue which unlike contact materials the application does need to cover the whole plant/grass.
CONTACT	Do not move around and only kill green leaf they actually hit so good coverage of the whole target is essential for effective control.
RESIDUAL	Products that sit in the top 2 cm of soil and remain active after initial application to control weeds that germinate in the subsequent weeks.

Products containing glyphosate alone (Gallup) would be classed as both a total and a translocated herbicide, but the inclusion of actives such as diflufenican and flufenacet adds residual activity.

Always read the label and ensure the product you intend to use:-

1. Will control the target weeds and that they are within the size range specified.
2. The weeds are actively growing and are not 'stalled' due to for example drought stress.

In addition, ensure that:-

3. Your application equipment is accurately calibrated and has the correct nozzle(s) to deliver the specified spray quality - fine, medium or coarse.
4. You have the correct PPE specified on the label.
5. You do not spray in conditions particularly windy or very high temperatures that could result in drift damage to non-target vegetation.
6. You have made provision for washing out empty pesticide containers and dealing with chemical washings in accordance with your legal obligations taking specific measures to avoid contamination of ditches and watercourses.

GRAZON PRO



A Selective Herbicide for spot spraying weeds in paddocks or pasture, PA1 / PA6 spraying certification is required to apply Grazon Pro.

Active ingredients: 240 g/litre Triclopyr (acid equivalent) present as 334 g/litre of Triclopyr Butotyl and 60 g/litre (5.5% w/w) Clopyralid. Spot treatment for docks, thistles and nettles.

For use in grassland such as paddocks.

1 x Litre

ORDER CODE: BGRAZ1LT

£68.05

DECIS PROTECH INSECTICIDE



Decis Protech is a non-systemic insecticide which acts by contact and ingestion to sucking and chewing insects. Its high lipophilicity provides a high affinity with the insect cuticle.

Active ingredient contains a broad-spectrum pyrethroid (15 g/l Deltamethrin) for control of aphids, caterpillars and other pests in agricultural, horticultural crops and amenity areas.

1 x 1 Litre

ORDER CODE: BDECIS1L

£33.02

INSECT & WEED CONTROL

INSECT control

PRODUCTS

GALLUP XL



Gallup XL is a foliar acting herbicide that controls annual and perennial grasses and most broad-leaved weeds when used as directed. It is translocated from treated vegetation growth to underground roots, rhizomes or stolons. Leaf symptoms, being a reddening then yellowing of the foliage, are first seen on grass weeds but take longer to appear on broad-leaved weeds. To purchase, you must have PA1 and PA6 certification for hand sprayers and PA12 if applied by automatic sprayer.

1 x 5 Litre	ORDER CODE: BGLYFOS5	£24.41
1 x 20 Litre	ORDER CODE: BGLYFO20	£87.23

GALLUP HOME & GARDEN AMATEUR PACK



360 g/l professional strength Glyphosate with 'clean wetting system' for sale to both non PA certified users and professionals requiring small quantities (covers approx. 1600 m²)

1 x 1 Litre	ORDER CODE: BGALHG1L	£12.13
1 x 2 Litre	ORDER CODE: BGALHG2L	£16.87

GALLUP BIOGRADE AMENITY



Gallup Biograde Amenity is a systemic herbicide that goes down to the plants roots and will kill most perennial and annual weeds. It's superior and clean formulation of 360 g/l Glyphosate that contains no hazardous wetting agents making it the product of choice when doing a COSHH assessment. It is ideal for clearing unwanted vegetation from most situations including permeable surfaces such as paths/driveways and to spot treat weeds on hard impermeable surfaces like paving (do not apply as a blanket spray to hard surfaces). Where it is applied to land that will subsequently be replanted a minimum of one week after application, sometimes longer (see label) is required before cultivating and replanting.

It is a professional product and must only be applied by an operator holding the relevant PA certification for the spray applicator to be used, for example PA1 and PA6 for Knapsack/other handheld sprayers.

1 x 5 Litre	ORDER CODE: BGALBIO5	£66.52
-------------	----------------------	--------

GREEN FORCE LAWN, FEED & WEED



Triple Action, high-performance fertiliser and moss killer, covers 435 m² yet only an 8.75 Kg bag, saving time and space. Perfect care for perfect lawns.

1 x 8.75 Kg	ORDER CODE: BGFLW875	£POA
-------------	----------------------	------

TRADITIONAL CREOSOTE



Traditional dark coloured preserver for above ground application.

For Professional Use Only.

APPROVED UNDER COPR/BPR

34 per pallet.

1 x 20 Litre	ORDER CODE: BCRED020	£POA
--------------	----------------------	------

CREOSOLVE LIGHT & DARK



For exterior use only. Similar physical/water repellency/application characteristics of traditional Creosote but contains no biocide/preserver. A bitumen/ wax-based treatment that helps to protect exterior rougher cut timber by repelling water and preventing ingress.

1 x 4 Litre Light	ORDER CODE: BCRSL004	£POA
1 x 4 Litre Dark	ORDER CODE: BCRSD004	£POA
1 x 20 Litre Light	ORDER CODE: BCRSL020	£POA
1 x 20 Litre Dark	ORDER CODE: BCRSD020	£POA

NOURISH & PROTECT WOOD PRESERVER



A high quality low odour solvent based, deep penetrating preserver which is used for the protection against wood destroying fungi (wet rot) , wood discolouring fungi and wood boring insects. Provides a semi-transparent matt / satin finish allowing the natural wood texture to be visible. Also no subsequent topcoat product is required unless for aesthetic purposes. For outdoor use and also for use on windows/frames, external doors/frames (internal & external sections). Other pack sizes and colours available. Contact the sales office for details.

Colour: Dark Brown

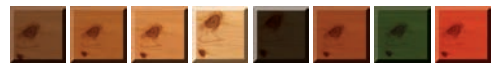

2 x 5 Litre	ORDER CODE: BWOLB005	£POA
1 x 25 Litre	ORDER CODE: BWODB025	£POA

NOURISH & PROTECT WOOD PROTECTIVE TREATMENT



An ideal wood treatment for outdoor timber structures such as Sheds, Fences, Trellis, Pergola and timber Gazebo's. A low build film product that absorbs into the wood with successive coats building onto the surface to give excellent water repellency and beading. Oil / Solvent based for deeper penetration of substrate. Contains water repellent resins and film biocide preserver to prevent surface growth of mould / algae and together this helps reduce decay, swelling, twisting of wood. Pigments have good UV fade resistance. Friendly to beneficial insects when dry. Other pack sizes and colours available.

Colour: Dark Brown



2 x 5 Litre	ORDER CODE: BPTDB005	£POA
1 x 25 Litre	ORDER CODE: BPTDB025	£POA

PREMIER CLEAR UNIVERSAL PRESERVER



Clear Universal Wood Preservative (CUWP) is a solvent-borne ready to use product. It contains active ingredients effective against wood destroying and wood discolouring fungi and against wood-boring insects. CUWP penetrates wood quickly and thereby gets deep into inner layers. It is moisture regulating and provides an adhesive surface suitable for glues, fillers, and solvent or water-based finishing treatments such as paints, varnishes and stains.

2 x 5 Litre

ORDER CODE: BUPCL005

£POA

LIGNUM INSECTICIDE PRO I62.5



Lignum Pro I62.5 is a concentrated professional product containing an insecticide to eradicate and prevent attack by wood boring beetles. It is highly effective against all life stages of wood-boring insects and woodworm. The formulation is water-based, producing a non-flammable, quick drying product containing no volatile organic compounds (VOCs). It has virtually no odour.

1 x 1 Litre

ORDER CODE: BLINING5

£26.53

LIGNUM FUNGICIDE AND INSECTICIDE PRO D156



This professional concentrated dual-purpose product contains an insecticide and fungicide to protect and preserve timber. It is designed to eradicate and prevent attack by wood boring beetles and prevent wood-destroying and discolouring fungi. Lignum Pro D156 is effective against a wide range of wood rotting fungi, including both wet rot and dry rot, whilst the pyrethroid insecticide is effective against all life stages of wood boring insects. It is also effective against fungal staining. The concentrated product is diluted with water and can be used during the drying out period after eliminating the source of damp. It is virtually odourless and can be applied either by brush or low pressure spray to provide long-lasting protection.

1 x 1 Litre

ORDER CODE: BLINGFUN

£34.98

LIGNUM PRO FUNGICIDE AND INSECTICIDE GEL



Ready to use deep penetrating "mayonnaise" type paste for the control and prevention of attack by wood-boring insects and wood rotting fungi. The active ingredients in the gel are highly effective against a wide range of wood-boring insects. The fungicide it contains has excellent efficacy against fungal decay. IPBC is added to protect against a range of wood staining fungi.

1 x 300 ml

ORDER CODE: BLING300

£16.55

1 x 7.5 Kg

ORDER CODE: BLIPRO7K

£152.25

KNOCKOUT® PATHWAY & PATIO CLEANER



Heavy duty acid-based cleaner, removes grime, dirt, leaf stains and is suitable for cleaning brickwork. Not suitable for use on calcareous or polished stone or tarmac. Always wear eye protection. Age-restricted.

18+

Each ORDER CODE: BPCAK004 £POA

KNOCKOUT® DRIVEWAY, DECKING & PATIO CLEANER



For cleaning patios, decking areas, concrete driveways / pathways and block paving. Kills unsightly mould, fungi and algae from decking, patios and other hard surfaces whilst cleaning general dirt and grime from the surface. Ready to use.

4 x 4 Litre ORDER CODE: BDECL004 £POA

PHUSION



A unique formulation of Phosphite and Silicon. To help improve crop health and quality. Analysis: 2.3-28.6-18-8 +3.1% Si (W/V)

1 x 5 Litre ORDER CODE: BPHUSION £75.00

ECOPLUG MAX



Ecoplug Max is a highly effective patented tree stump killer. Each plug contains 300 mg of granular Glyphosate herbicide. Once inserted and hammered in place, Ecoplug Max releases glyphosate through the sides directly into the tree stumps.

1 x 100 ORDER CODE: BECOPLUG £90.54



ROUND UP ECO PLUG DRILL BIT
Each ORDER CODE: BECOPDRI £15.27

LED ELECTRIC FLY KILLERS

NEW

NANO G4 LED

The new Nano G4 fly control unit embraces the latest LED (light-emitting diodes) technology which uses less power consumption when compared to standard electronic ballast machines, resulting in a cost-saving for the customer on all-year-round operating costs. LED technology can save as much as 75-80%* in energy consumption when compared to traditional UV fly units. The Nano G4 LED shatter-proof lamps have an in-built driver that makes for easy tool-free servicing and further cost savings. Nano G4 is the professional UK manufactured glue board fly control unit suitable for restaurants, kitchens, food shops etc., where flying insects pose a problem. (*Dependant upon the comparable fly unit).



Features & Benefits:

1. Long life LED lamps
(Lamps are recommended to be changed every three years)
2. Made for wall mounting, suspending or free standing
3. 'Lift and lock' front guard enables tool free servicing
4. Annual cost savings
5. Competitively priced
6. Available in White or Stainless steel
7. Versatile installation
8. Shatter-proof lamps as standard
9. Dimensions: W 50 x H 35.5 x D 12 cm
10. Coverage: Up to 100sq/m (*Dependant upon the comparable fly unit)

White

ORDER CODE: BBFGNAG4

£144.83

Stainless Steel

ORDER CODE: BBFGNG4S

£172.60

NEW

VULCAN 6 LED

The stylish, contemporary design of the Vulcan 6 with stainless steel front-guard is ideal for virtually any application (front of house or behind the scenes). The new Vulcan 6 fly control unit combines the latest LED (light-emitting diodes) technology which uses less power consumption when compared to traditional fly control units, resulting in a cost-saving for the customer on all-year-round operating costs. LED technology can save as much as 75-80%* in energy consumption when compared to traditional UV fly units. The Vulcan 6 LED shatter-proof lamps have an in-built driver that makes for easy tool-free servicing and further cost savings. (*Dependant upon the comparable fly unit)

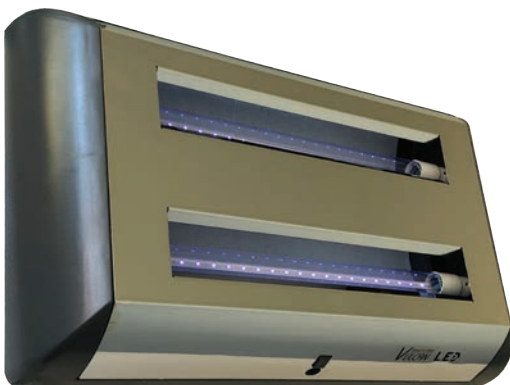

Features & Benefits:

1. Long-life LED lamps
(Lamps are recommended to be changed every three years)
2. Annual cost savings due to low energy operating costs
3. Wall-mounted installation
4. Shatter-proof lamps as standard
5. Dimensions: W 59 x H 35 x D 10.5 cm
6. Coverage: Up to 80sq/m

Each

ORDER CODE: BBFGVUL6

£167.77

NEW

VULCAN 8 IP65 LED

The stylish, contemporary design of the Vulcan 8 with stainless steel front-guard is ideal for areas where wash downs regularly occur, due to the unit being IP65 rated. The new Vulcan 8 fly control unit combines the latest LED (light-emitting diodes) technology which uses less power consumption when compared to traditional fly control units, resulting in a cost-saving for the customer on all-year-round operating costs. LED technology can save as much as 75-80%* in energy consumption when compared to traditional UV fly units. The Vulcan 6 LED shatter-proof lamps have an in-built driver that makes for easy tool-free servicing and further cost savings. (*Dependant upon the comparable fly unit)



Features & Benefits:

1. IP65 Rated
2. Long-life LED lamps
(Lamps are recommended to be changed every three years)
3. Annual cost savings due to low energy operating costs
4. Wall-mounted installation
5. Shatter-proof lamps as standard
6. Dimensions: W 59 x H 35 x D 10.5 cm
7. Coverage: Up to 80sq/m

Each

ORDER CODE: BBFGVUL8

£229.46

NEW

LED EFK REPLACEMENT PARTS

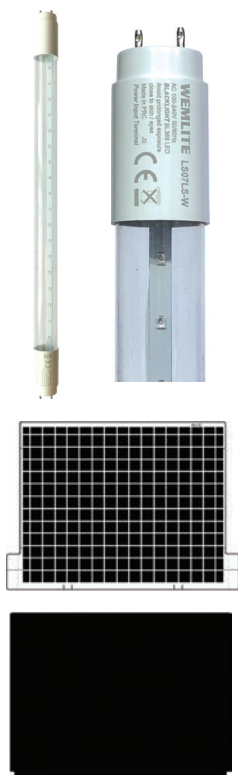

Replacement LED Lamps

7w Wemlite LED shatter-resistant lamp featuring an in-built driver.

Replacement Nano Glue Boards

High strength adhesive glue boards (pack of 6) replacements for the Nano G4 LED fly unit.

Replacement Vulcan Glue Boards

High strength adhesive glue boards (pack of 6) replacements for the Vulcan LED fly units.

REPLACEMENT LED LAMP

Each

ORDER CODE: BBTS7LS-W

£24.06

NANO G4 REPLACEMENT GLUE BOARD (Dims: 479 x 350 mm)

Pack of 6

ORDER CODE: BMGLTR3

£26.63

VULCAN 6 / VULCAN 8 REPLACEMENT GLUE BOARDS (Dims: 415 x 339 mm)

Pack of 6

ORDER CODE: BMGNTR3

£21.86

REPLACEMENT GLUE BOARDS & PARTS



Other boards available on request. Glue strength will last a maximum of 4 months in the field.

REPLACEMENT GLUE BOARDS

*Below boards manufactured for Barretine to match the exact sizes of the common units listed.

ORDER CODE	MODEL	PRICE
BCH12BRD	Chameleon 1 x 2	£31.01
BCH44BRD	Chameleon 4 x 4	£69.36
BFICSFIL	Rentokil FICS MK.1	£19.39
BMGNTR3	Nano G30	£21.86
BBMGCTR3	6 x replacement boards for FlyCheck	£22.07
BBMG2TRA	6 x replacement boards for Fly Shield 2 & 4	£22.07
BBMG1TRA	6 x replacement boards for Fly Shield 1	£10.93
BMG6TRA	6 x replacement boards for Glu-60	£28.86
BBMGPTR5	5 x replacement boards for Plug-In Fly Killer	£3.94
BBMGLTR3	6 x replacement boards for Vulcan	£26.63
BMGVTR2	6 x replacement boards for Vanquish	£30.55
BMGSTR1	6 x replacement boards for Fly Shield Solo	£9.68
BBMGFTR2	6 x replacement boards for Fusion 2	£27.17
BBMGFTR4	6 x replacement boards for Fusion 4	£30.56

FLY CATCH TRAYS



Extension Cluster Fly Tray

An extra-deep stainless steel catchment box with anti-crawl lips that can be fitted to cope with large infestations of cluster fly. Compatible with Nano H30, T35 & T651.

Compact Circline Catch Tray

Made from stainless steel, this extra deep fly catch tray is an essential extra when dealing with cluster flies.



BEXCLUST	Cluster Fly Extension Tray	£70.46
BCIRTRAY	Compact Circline Catch Tray	£59.73

EFK STARTERS

Starter for use in fly control units with fluorescent lighting. Box of 10.



BBSST22X	EFK Starter	£5.62
----------	-------------	-------

BULB REPLACEMENT PARTS / ACCESSORIES

FULL BOX OFFER
25% OFF



ORDER CODE	WATTS	SIZE	BOX QTY	TYPE	PRICE
BBTS8WXX	8	12" x 5/8" dia.	25	Std BL	£3.67
BBTS8WXS	8	12" x 5/8" dia.	25	BL Shatter resistant	£5.68
BBTS14WX	15	12" x 5/8" dia.	25	Std (Wemlite) BL	£4.15
BBTS14WS	15	12" x 5/8" dia.	25	BL Shatter resistant	£10.54
BBTS15WX	15	18" x 1" dia.	25	Std (Wemlite) BL	£3.43
BBTS15WS	15	18" x 1" dia.	25	BL (Wemlite) Shatter resistant	£5.34
BBTS20WX	20	24" x 1 1/2" dia.	25	Std BL - Sylvania	£6.62
BBTS20WS	20	24" x 1 1/2" dia.	25	BL Shatter resistant - Sylvania	£14.24
BBTS40WX	40	24" x 1 1/2" dia.	25	Std BL	£4.09
BBTS40WS	40	24" x 1 1/2" dia.	25	BL Shatter resistant	£11.36
BBTS40QS	40	24" x 1 1/2" dia.	25	Shatter resistant - Quantum BL	£12.27
BBTC22WX	22	8" Circline	12	Std BL	£7.95
BBTC22WS	22	8" Circline	12	Shatter resistant - Wemlite	£16.32
BBTT25WX	25	9 1/2" x 2 1/4"	20	Std BL	£7.63
BBTT25WS	25	9 1/2" x 2 1/4"	20	BL Shatter resistant	£11.31
BBTL11WX	11	9 1/4" x 1 1/4"	20	Std BL - Wemlite	£6.94
BBTL11WS	11	9 1/4" x 1 1/4"	20	BL Shatter resistant - Wemlite	£11.05
BBTL18WX	18	8 3/4" x 1 3/4"	20	Std BL - Sylvania	£13.65
BBTL18WS	18	8 3/4" x 1 3/4"	20	BL Shatter resistant - Sylvania	£13.99



INSECT SAMPLING

BUG JAR



High quality x 4.8 bug jar magnifier.

Each

ORDER CODE: BMAG5837

£6.72

INSECT SAMPLING



Convenient and easy way to collect samples in the field. Simply suck on the tube whilst placing the other straw over the insect (will stop you receiving a mouthful!) and you can professionally collect insects large and small for identification etc, without damaging them.

Each

ORDER CODE: BBUGISPO

£7.90

INSECT SAMPLE CONTAINER



Ideal container to collect insect samples from the field, e.g. for further identification.

1 x 20

ORDER CODE: BBUGSBOX

£4.64

ESCHENBACH x10 SPECIMEN VIEWER

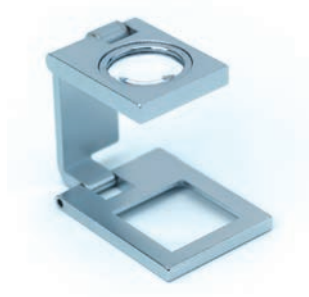

A pocket-size magnifier. Bi-convex, optically ground silicate glass lens. x 10 magnification. High-quality chrome plated brass frame folds neatly away. Ideal for on-site or in the office for a quick analysis of insects etc.

Each

ORDER CODE: BMAG1255

£32.68

RED SPOT DOUBLE ENDED FOLDING LOOP

High-quality chrome plated case. Double-ended magnifier. 10X and 20X magnification.



Each	ORDER CODE: BMAG3003	£19.63
------	----------------------	---------------

ASPIVENIN® BITE & STING RELIEVER

Every Pest controller should have one. Aspivenin is a unique & natural treatment that brings relief from bites & stings. Aspivenin is a special vacuum mini-pump that draws poison from insect stings & insect bites.



Each	ORDER CODE: BASPIBSR	£17.55
------	----------------------	---------------

TECHNICIANS FIELD GUIDE

A complete and essential guide for the professional.

The Barrettine's pocket-size A6 Pest Technicians guide contains detailed information to assist in the daily routine of a Professional Pest Control Operator: A 'how to' guide covering topics of insect and rodent information and identification, equipment calibration, non-chemical insect control measures, pesticide application and product safety, dealing with waste: Triple rinsing as well as detailed information on LD₅₀.

PRICE: £23.03
ORDER CODE: BPIDBOOK

Barrettine Environmental Health

This Pest Field Guide was compiled by the Technical & Marketing staff of Barrettine Environmental Health. © 2019 Barrettine Environmental Health. All rights reserved.

FLYING INSECTS
CRAWLING INSECTS
SPI, AGRICULTURE & AMENITY PESTS
RODENT PESTS
BIRD PESTS

INSECT CONTROL - INSECT SAMPLING & STING RELIEVER



RODENTICIDES

RODENT MONITORING

BAIT STATIONS & FIXINGS

SENSORY TECHNOLOGY

SNAP & LIVE CATCH TRAPS

PROOFING

FUMIGANTS & REPELLENTS

DRAINAGE SYSTEMS

HYGIENE, DISINFECTANTS & TOOLS

DECANTING & STORAGE

RODENT control

PRODUCTS 

PEST CONTROL CATALOGUE 2021

Products marked up as “Professional” can only be used by professional users holding certification demonstrating compliance with UK rodenticide stewardship regime requirements. Read the label before use. Using these products in a manner that is inconsistent with the label may be an offence. Refer to the CRRU UK Code of Best Practice (or equivalent) for guidance. When this product is supplied to a user for the control of rodents, it shall only be supplied to a professional user holding certification demonstrating compliance with UK rodenticide stewardship regime requirements”.

RODENT control

PRODUCTS

COUMATETRALYL

Excellent efficacy against rats and demonstrates reduced risks of secondary poisoning.

PROFESSIONAL

ROMAX® RAT CP (SOFT BLOCK)



Contains 0.0375 % (w/w) Coumatetralyl. Based on a special 100 g 'soft block' formulation, this bait has proved to be particularly attractive to rats. Indeed tests have shown it to be preferred to cereal-based baits. As a block, however, it is 'non-spill' and can be secured in place. It has proved to be effective against both the 'good feeders' and the more difficult to control 'hesitant feeders' in the rat population, and as a multi-feed bait, can be as potent as Brodifacoum.

- Reduced risk of secondary poisoning.
- Unique active ingredient.
- Highly palatable.
- Palatable and securable 'soft bait' formulation.

Approval No: UK-2016-0953-001



1 x 5 Kg

ORDER CODE: BRRATCP5

£38.66

PROFESSIONAL

RACUMIN® FOAM

IR



Contains 0.4 % (w/w) Coumatetralyl. Racumin® Foam is a new, non-bait rodenticide from Bayer, offering an alternative method to control rat and mice infestations. This truly innovative foam formulation works with the rodent's natural grooming habits and is effective as a result. When faced with difficult to access areas, Racumin® Foam is for indoor use and can be applied in known rat runways, passages, entrance points / holes, covered tracks and wall cavities.

Approval No: UK-2014-0860

Supplied with free contact station, pictured below.

FREE ROMAX® CONTACT STATION

6 x 500 ml

ORDER CODE: BRACFO.5

£41.21

ROMAX® CONTACT STATION



The Station was designed to allow contact rodenticides currently available to be applied within the station to allow rodents to come into contact with the active ingredients. Following the rodent control program, the contact stations can be conveniently removed.

The unique design of the Romax® Contact Station incorporates end flaps on either side of the station that has the effect of increasing the transfer area of the active ingredient to the coat of the rodent as the rodent passes through the station.

1 x 4

ORDER CODE: BBBROCT4

£6.06

Save time, place your order any time.

PAY ONLINE

BarrettineEnv.co.uk



USER FRIENDLY



EASY TO SIGN UP



LATEST PRODUCTS & PROMOTIONS





Racumin[®]
FOAM

Expand your rodent control

////// Even in the *hardest to reach areas.*

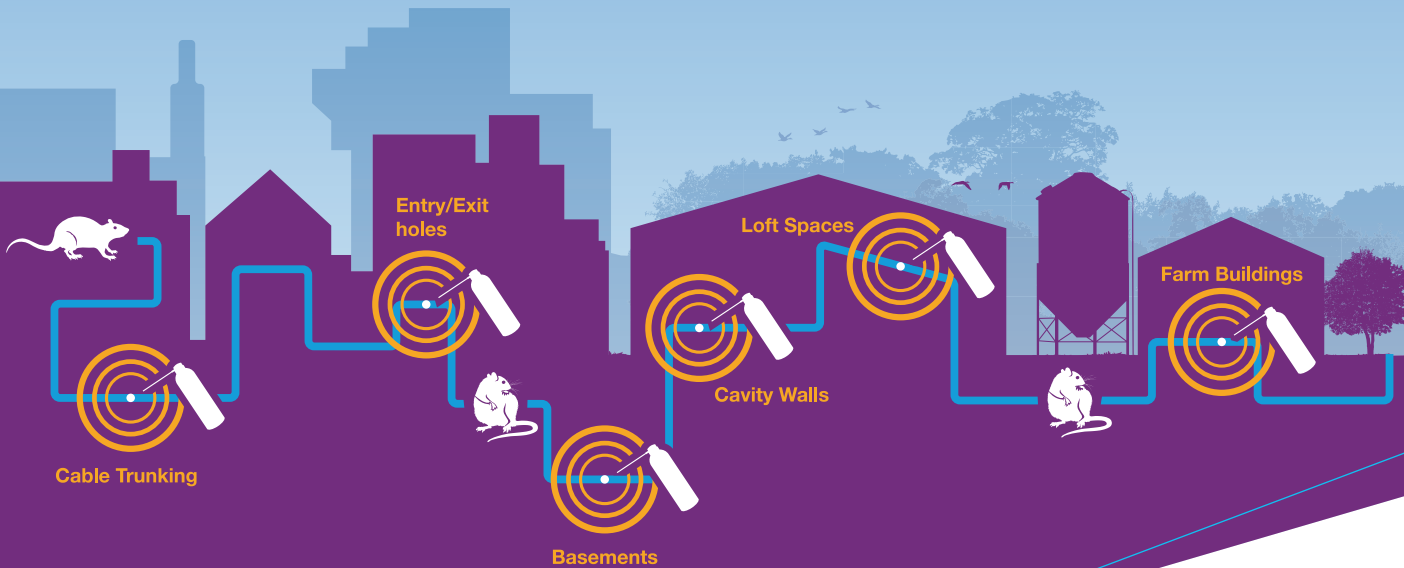

////// **Innovative** *rodenticide.*

Racumin[®] Foam is an innovative, non-bait rodenticide from Bayer. Applied in known rodent runways, the foam sticks to the rodent's coat and is ingested through grooming.

- // Quick and easy to apply; ready to use product
- // Tackles palatability and bait shyness issues
- // Can be placed in areas where traditional baiting methods are not possible

USE BIOCIDES SAFELY. ALWAYS READ THE LABEL AND PRODUCT INFORMATION BEFORE USE. PAY ATTENTION TO THE RISK INDICATIONS AND FOLLOW THE SAFETY PRECAUTIONS ON THE LABEL. For further product information including warning phrases and symbols refer to product label or www.environmentalscience.bayer.co.uk. Racumin[®] Foam contains 0.4% w/w coumatetralyl. BPR:UK-2014-0860, IE/BPA 70160. Racumin[®] Foam is a registered trademark of Bayer CropScience Ltd. © Copyright of Bayer 2021. Product image for illustration purposes only, the design of the product is subject to change.

Bayer CropScience Ltd, 230 Cambridge Science Park, Milton Road, Cambridge, CB4 0WB
Tel: 00800 1214 9451 | Fax: 01223 226635 | Email: pestsolutions@bayer.com | www.environmentalscience.bayer.co.uk



Bayer

RODENT control

PRODUCTS

BROMADIOLONE & DIFENACOU

A combined active demonstrating excellent efficacy against rats and mice. Block and pasta formulation contain FLUO-NP, UV tracking technology.

PROFESSIONAL

ROMAX® MUSKIL® WHOLE WHEAT



Contains 0.0025 % Difenacoum & 0.0025 % Bromadiolone. For use against rats & mice, in and around buildings. Romax® Muskil® is formulated using high-quality food-grade whole wheat, blended with feeding enhancers to improve palatability. The active ingredients are applied using Special Absorption Technology and the wheat is treated to prevent germination which increases the quality of the product without affecting its palatability. Permanent baiting approved. Safety - Contains denatonium benzoate.



Approval No: UK-2012-0661

1 x 4 Kg	ORDER CODE: BMUSW04K	£23.40
1 x 10 Kg	ORDER CODE: BMUSW10K	£38.57

PROFESSIONAL

ROMAX® MUSKIL® WHOLE WHEAT SACHETS



Contains 0.0025 % Difenacoum & 0.0025 % Bromadiolone. For use against rats & mice, in and around buildings. Romax® Muskil® 50 g sachets are formulated using high-quality food-grade whole wheat, blended with feeding enhancers to improve palatability. The active ingredients are applied using Special Absorption Technology and the wheat is treated to prevent germination which increases the quality life of the product without affecting its palatability. Permanent baiting approved. Safety - Contains denatonium benzoate

Contains: 100 x 50 g Sachets

Approval No: UK-2012-0661

1 x 5 Kg	ORDER CODE: BMUSWSA5	£41.36
----------	----------------------	--------

PROFESSIONAL

ROMAX® MUSKIL® BLOCK

FLUO-NP®
UV TRACKING TECHNOLOGY



Contains 0.0025 % Difenacoum & 0.0025 % Bromadiolone. For use against rats & mice, in and around buildings. A 25 g wax block manufactured from high-quality food-grade ingredients with a predrilled hole to facilitate easy securing in bait stations. Romax® Muskil® Fluo NP® is formulated with unique Fluorescent No Phobia technology which significantly improves the primary acceptance of the bait resulting in faster kill whilst also allowing for tracking. Permanent baiting approved. Safety - Contains denatonium benzoate

Approval No: UK-2013-0757

1 x 3.5 Kg	ORDER CODE: BMUSB3.5	£31.39
1 x 7 Kg	ORDER CODE: BMUSBB7K	£58.33

PROFESSIONAL

ROMAX® MUSKIL® PASTA

FLUO-NP®
UV TRACKING TECHNOLOGY



Contains 0.0025 % Difenacoum & 0.0025 % Bromadiolone. For use against rats & mice, indoors and outdoors. A 15 g sachet containing pasta manufactured from high-quality food-grade ingredients that can be secured in bait stations. Romax® Muskil® Fluo NP® is formulated with unique Fluorescent No Phobia technology which significantly improves the primary acceptance of the bait resulting in faster kill whilst also allowing for tracking. Permanent baiting approved. Safety - Contains denatonium benzoate

Approval No: UK-2013-0756

1 x 4 Kg	ORDER CODE: BMUSPA4K	£37.35
----------	----------------------	--------

BROMADIOLONE & DIFENACOU M

RODENT control

PRODUCTS

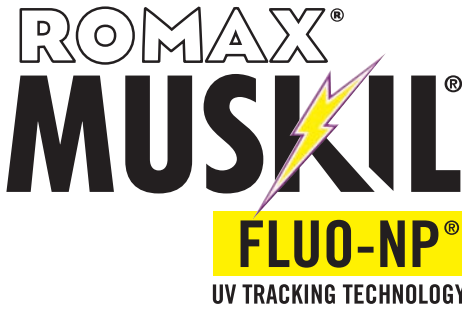

AVAILABLE IN THREE BAIT FORMULATIONS

Romax® Muskil® technology is based on high-grade food ingredients containing natural feeding enhancers. The block and pasta formulations have the FLUO-NP® technology, a fluorescent tracking component that helps monitor rodent activity including routes of travel by using a UV torch on faeces deposited. Fluorescent tracking is also a useful tool to help monitor if the bait is being consumed by the target rodent. Research has also shown Romax® Muskil® FLUO-NP® baits are more attractive than standard baits resulting in accelerated acceptance by rodents. All of these features combined with the patented combination of low dose actives give Romax® Muskil® its superior palatability with rodents exhibiting no signs of bait shyness.

ROMAX® MUSKIL® PASTA – The fastest solution.

Laboratory tests show speed of kill compared with other actives.

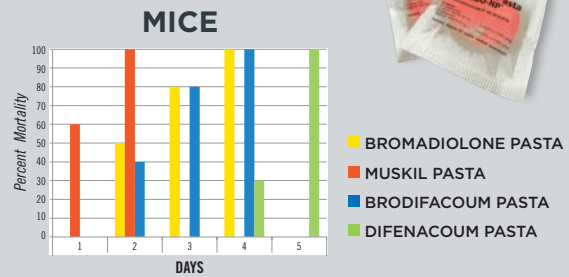
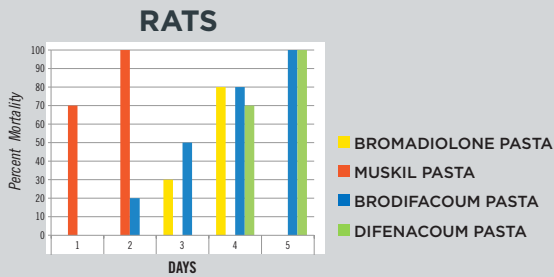

Field tests and commercial usage in Europe has proven that Romax® Muskil® pasta is the fastest solution for controlling both rats and mice. The bait is packed in single dose filter bags which preserves the attracting characteristics effectively maintaining the palatability and performance in a wide range of environments.

ROMAX® MUSKIL® WAX BLOCK – Proven palatability.

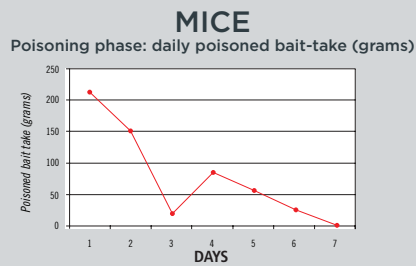
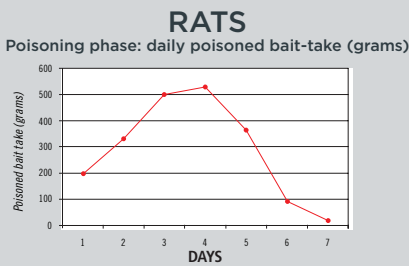

An extruded wax block produced with a central hole for anchoring into bait stations with edges to encourage gnawing. The block which has the unique Romax® Muskil® formulation, makes it highly attractive to both rats and mice while remaining durable in challenging conditions of high humidity and moisture.

ROMAX® MUSKIL® WHOLEWHEAT – Special Absorption Technology

The whole wheat is produced using special absorption technology which ensures an even distribution of the twin active ingredients throughout the grain which means Romax® Muskil® will be equally effective on mice that kibble (dehusk whole wheats).

SPECIAL ABSORPTION TECHNOLOGY



- Treated using special absorption techniques.
- Active ingredients are evenly distributed through to the core of the grain.

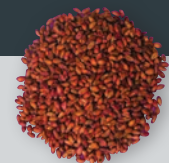

DIFENACOUM

REVOLUTIONARY
TWIN ACTIVE

BROMADIOLONE

ROMAX[®]

BROMADIOLONE 0.0025% (W/W)
DIFENACOUM 0.0025% (W/W)
DENATONIUM BENZOATE 0.001% (W/W)

MUSKIL[®]

FLUO-NP[®]

UV TRACKING TECHNOLOGY

IDEAL FOR USE IN ACCORDANCE WITH
RODENTICIDE STEWARDSHIP CONDITIONS

- ✓ **SPEED OF KILL**
MORE THAN TWICE AS FAST
COMPARED TO OTHER ACTIVES TESTED
- ✓ **RAPID BAIT ACCEPTANCE**
SUPERIOR PALATABILITY
- ✓ **EFFECTIVE AGAINST CERTAIN**
ANTICOAGULANT RESISTANT RATS & MICE
LABORATORY TESTING (Y139S & Y139C)
- ✓ **LESS BAIT PER PROGRAMME**
MORE COST EFFECTIVE
- ✓ **UV TRACKING TECHNOLOGY**

50g SACHETS



Available in three formulations
WHEAT • BLOCK • PASTA

MUSKIL[®] and FLUO-NP[®] are registered trademarks of Zapi S.P.A.
ROMAX[®] is a registered trademark of Barrettine
USE BIOCIDES SAFELY. ALWAYS READ THE LABEL AND PRODUCT INFORMATION BEFORE USE.

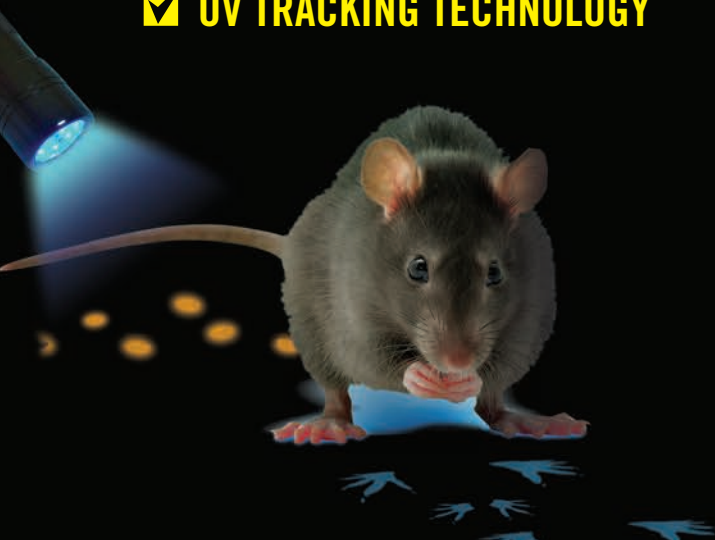

BROMADIOLONE

Bromadiolone is a second generation anticoagulant offering a high degree of potency. Available in many formulations.

RODENT control

PRODUCTS

PROFESSIONAL

ROMAX® B WHOLE WHEAT



Contains 0.005 % Bromadiolone for use against rats & mice. Romax® is formulated using high-quality food grade whole wheat, blended with feeding enhancers and adjuvants to improve palatability. The wheat is also treated to prevent germination which increases the quality of the product without affecting its palatability. Safety - Contains denatonium benzoate

Approval No: UK-2014-0814

BUY 4 GET 1 FREE
20% OFF
Applies to 10 Kg only.

1 x 3 Kg

ORDER CODE: BRBROM3K

£16.77

1 x 10 Kg

ORDER CODE: BRBROM10

£27.46

PROFESSIONAL

ROMAX® BROMABLOCK



Contains 0.005 % Bromadiolone. A highly palatable 25 g block for use against rats and mice.

Approval No: UK-2013-0777

1 x 5 Kg

ORDER CODE: BVBBROM5

£34.48

PROFESSIONAL

CONTRAC ALL-WEATHER BLOX IR



Contains 0.005 % (w/w) Bromadiolone plus Bitrex. A 28 g second generation, multi-edged rat and mouse bait manufactured through a unique extrusion process that yields bait unsurpassed in rodent acceptance and control. Formulated with a special blend of food-grade ingredients and low wax content, Contrac BLOX stays fresh and palatable in wet and dry areas. IR(93432). Permanent baiting approved.

Approval No: UK-2015-0941

Standard pallet of 36

1 x 8 Kg

ORDER CODE: BCOBX008

£68.32

PROFESSIONAL

CONTRAC SUPER BLOX IR



Contains 0.005 % (w/w) Bromadiolone plus Bitrex. A 225 g powerful extruded bait, containing Bromadiolone. Super BLOX has been proven to be particularly effective in sewer baiting. Supplied with hanging wires. IR(96125).

Approval No: UK-2015-0941



40 x 225 g

ORDER CODE: BCOSB.22

£64.90

**#1 CHOICE OF
PEST MANAGEMENT
PROFESSIONALS**



CONTRAC®

- ▶ Most popular rodenticide with superior acceptance
- ▶ Especially good for sensitive areas and general use
- ▶ Available in blox, super-size blox, and pellets



SOLO®

- ▶ Strongest anticoagulant available
- ▶ Highly palatable formula
- ▶ Available in blox and super-size blox



DETEX®

- ▶ Lumitrack is a special additive that makes rodent droppings glow bright green under UV light
- ▶ Quickly and easily identify and track rodent movement
- ▶ Bait & Switch – once rodents feed on Detex, replace with one of Bell's rodenticides
- ▶ Available in blox and soft bait sachets

Use rodenticides safely. Always read the label and product information before use.



THE WORLD LEADER IN RODENT CONTROL TECHNOLOGY®

www.belllabs.com | emea@belllabs.com

BROMADIOLONE

PROFESSIONAL

CONTRAC RODENTICIDE PLACE PACKS



Contains 0.005 % (w/w) Bromadiolone plus Bitrex. Contrac rodenticide is available in handy 50 g place packs. Made of polyglassine. Bait odour can escape so rodents readily gnaw into the packs themselves. The slender packs easily fit down burrows, in bait stations and hard-to-reach places. Standard outer 4

Approval No: UK-2015-0919

100 x 50 g

ORDER CODE: BCORM50g

£43.72

PROFESSIONAL

DEADLINE RAT & MOUSE WHEAT

IR



Contains 0.005 % Bromadiolone on whole wheat. For use in dry and damp locations. Specially treated to remain fresh and palatable when used in damp locations. IR(95181)

Approval No: UK-2014-0827

1 x 10 Kg

ORDER CODE: BDEAD010

£29.06

BUY 5 GET 1 FREE
16.5% OFF

PROFESSIONAL

DEADLINE MOUSE BAIT BLOCKS

IR



Contains 0.005 % Bromadiolone (Double strength). The blocks are made from cereal which is bound in a novel, edible, non wax material. IR(95184)

Approval No: UK-2014-0811

480 x 10 g

ORDER CODE: BDEADMBL

£46.14

PROFESSIONAL

DEADLINE RAT BAIT BLOCKS

IR



Contains 0.005 % Bromadiolone. Deadline bait blocks can be used indoors, outdoors and in damp conditions including sewers. IR(95185)

Approval No: UK-2014-0812

72 x 120 g

ORDER CODE: BDEADRBL

£67.91



PROFESSIONAL

DEADLINE BROMADIOLONE PASTE



Contains 0.005 % (w/w) Bromadiolone plus bitrex. Deadline is a highly palatable caulkable bait formulation, ideal when there are competing food resources and rodents are reluctant to take the bait.

Standard outer 12

Approval No: UK-2013-0750

12 x 300 g

ORDER CODE: BDEADPST

£82.10

DIFENACOU M

Difenacou m is a second generation active ingredient. A high degree of potency - available in a wide range of formulations.

PROFESSIONAL

ROMAX[®] D WHOLE WHEAT



Contains 0.005 % Difenacou m. For use against rats & mice, indoors and around buildings. Romax[®] is formulated using high-quality food- grade whole wheat, blended with feeding enhancers and adjuvants to improve palatability. The wheat is also treated to prevent germination which increases the product's quality without affecting its palatability. Safety - Contains denatonium benzoate

Approval No: UK 2014-0808

1 x 3 Kg

ORDER CODE: BRDIFE3K

£16.77

PROFESSIONAL

ROMAX[®] D WHOLE WHEAT



Contains 0.005 % Difenacou m. For use against rats & mice, indoors and around buildings. Romax[®] is formulated using high-quality food-grade whole wheat, blended with feeding enhancers and adjuvants to improve palatability. The wheat is also treated to prevent germination which increases the product's quality without affecting its palatability. Safety - Contains denatonium benzoate

Approval No: UK 2014-0808

1 x 10 Kg

ORDER CODE: BRDIFE10

£27.46

BUY 4 GET 1 FREE
20% OFF

DIFENACOU M

RODENT control

PRODUCTS

PROFESSIONAL

ROMAX® D 50 g WHOLE WHEAT SACHETS



Contains 0.005 % Difenacou m. Whole wheat packed in 100 x 50 g sachets. The sachets do not need to be opened as the rodents will eat through the packaging material.
Safety - Contains denatonium benzoate

Approval No: UK 2014-0808

1 x 5 Kg

ORDER CODE: BRDIFSA5

£34.55

PROFESSIONAL

ROMAX® D BLOCK

IR



Contains 0.005 % Difenacou m. A highly palatable 20 g block.
Safety - Contains denatonium benzoate

Approval No: UK-2011-0077 & IEIBPA70419



1 x 5 Kg (UK)

ORDER CODE: BRODBLOX

£35.10

1 x 5 Kg (IRE)

ORDER CODE: BRODBLIE

PROFESSIONAL

ROMAX® DP PASTE



Contains 0.005 % (w/w) Difenacou m. Romax® DP is a high-calorie bait that has been specially formulated to offer extraordinary palatability and control problem mice infestations - based on a mixture of oils and attractive food bases.

Approval No: UK-2013-0804

12 x 300 g

ORDER CODE: BRDP300G

£89.32

MINT
EXCLUSIVE MEMBERSHIP



Join our exclusive
Mint Membership
it's 100% free.

Register today online or contact our sales office

Email: beh@barrettine.co.uk

www.barrettineEnv.co.uk

PROFESSIONAL

NEOSOREXA GOLD

IR



Contains 0.005 % (w/w) Difenacou m. Neosorex a Gold panders to rodents natural foraging behaviour and provides a bait that stimulates all the rodents senses. Using a mixture of patented for aging pellets and unique taste and smell, field data demonstrate that rats and mice consume bait quicker and in greater quantities. IR(70053)

Approval No: UK-2012-0304

1 x 3 Kg

ORDER CODE: BNERG003

£24.26

1 x 10 Kg

ORDER CODE: BNERG010

£55.36

PROFESSIONAL

NEOSOREXA GOLD RATPACKS

IR



Neosorex a® Gold Ratpacks are a ready-to-use rodenticide with an active ingredient of 0.005 % (w/w) Difenacou m for the control of brown rats and black rats, including strains resistant to other anticoagulants. Neosorex a® Gold Ratpacks are a mixture of foraging grains and cut wheat contained within the rodent bait. It is the first rodent bait to use Fortec™ technology which improves the palatability for rats and mice. IR(70054)

100 g Sachets.

Approval No: UK-2012-0306

1 x 5 Kg

ORDER CODE: BNEPG005

£52.61

PROFESSIONAL

SOREXA D MOUSE BAIT

IR



Contains 0.005 % (w/w) Difenacou m. Sorex a D is a specialist bait designed for mice control. The bait is based on canary seed, which frequently comes out top in preferred food for mice. IR(70059)

Approval No: UK-2012-0319

1 x 3 Kg

ORDER CODE: BSOCM003

£54.53

1 x 10 Kg

ORDER CODE: BSOCM010

£175.17

PROFESSIONAL

NEOSOREXA BAIT BLOCKS

IR



Contains 0.005 % Difenacou m in a 26 g oval block form. Purposely developed to be effective as loose bait without the risk of wastage. IR(70051)

Approval No: UK-2012-0360

1 x 5 Kg

ORDER CODE: BNEBL005

£42.93

1 x 10 Kg

ORDER CODE: BNEBL010

£78.08

DIFENACOU M

PROFESSIONAL

DEADLINE RAT & MOUSE WHEAT



A high quality whole-wheat based anticoagulant rodenticide to control rats and mice in both indoor and around buildings. Specially formulated to resist the growth of mould and remain highly palatable.

Approval No: UK-2012-0591

BUY 5 GET 1 FREE
16.5% OFF

1 x 10 Kg

ORDER CODE: BDEDIF10

£29.06

PROFESSIONAL

DEADLINE DIFENACOU M PASTE



A very attractive wheat-based paste formulation for the control of mice in tamper-resistant bait boxes. Easy to apply with little wastage.

Approval No: UK-2011-0148

12 x 300 g

ORDER CODE: BDEADDPS

£82.10

KNOCKOUT® D PASTA SACHET 29ppm



A highly palatable ready-to-use pasta formulation for the control of rats and mice. Authorised for 'Non-Certified' users. Contains Difenacou m 0.0029 % (w/w). Proven to be a fast and effective, potent rodenticide.

Approval No: UK-2013-0722

24 x 150 g

ORDER CODE: BKNOCKPA

£46.65

KNOCKOUT® D BLOCK 25ppm



A highly palatable ready to use block formulation for the control of rats and mice. Authorised for 'Non-Certified' users. Contains Difenacou m 0.0025 % (w/w). Proven to be a fast and effective potent rodenticide.

Approval No: UK-2016-0994-0005

12 x 300 g

ORDER CODE: BRODBL25

£51.03

PROFESSIONAL

RODILON® WHEAT TECH 25ppm

IR



Ideal for rat control, Rodilon® Wheat Tech uses the highest quality whole wheat grain making it extremely palatable and increases consumption. It is perfect for difficult to control infestations throughout a wide range of baiting situations.

Approval No UK: UK-2011-0051
Approval No IRELAND: IE/BPA 70569-001

1 x 10 Kg

ORDER CODE: BRODWT10

£78.09

PROFESSIONAL

RODILON® TRIO 25ppm



Developed specifically for the control of mice, Rodilon® Trio incorporates oats, sunflower seeds and maize, which are known to be particularly palatable to mice. Despite mice removing the husk of the grain before eating, the process of 'Turbo Impregnation' ensures that the core still contains the active ingredient.

Approval No: UK-2011-0050

1 x 3 Kg

ORDER CODE: BRODTR.3

£45.63

PROFESSIONAL

RODILON® SOFT BLOCK 25ppm



Rodilon® Soft Blocks are suitable for mice and rats and are an excellent choice where there are other food options available. Containing high food-grade ingredients in pre-measured 10 g sachets, Rodilon® Soft Blocks offers the added benefits of no direct contact to the farmer and ease of handling.

Approval No: UK-2011-0043

1 x 5 Kg

ORDER CODE: BRODSBL5

£44.26

We've made it
SUPER EASY

TO ORDER ONLINE

BarrettineEnv.co.uk





New Storm[®] Ultra Secure

Take them by Storm[®]

Efficient, reliable & cost effective rodent control

Storm[®] Ultra Secure is a 25ppm rodenticide that has the palatability of a pasta in a block, and is at least twice as palatable as leading anticoagulant bait blocks. This single feed bait offers effective control, even against rats and mice with anticoagulant resistance. It can be used in extreme temperatures, has a high resistance to mould and contains no wax which makes it more appealing to rodents. If you need to control rodents, take them by Storm.

- Ultra palatable** for rats and mice
- Ultra resistant** to extreme conditions
- Ultra effective** with just a single feed
- Ultra quick control** of rodent infestations

PROFESSIONAL

STORM® SECURE BAIT BLOCKS

IR



Contains 0.005 % Flocoumafen. Storm is a highly potent anticoagulant rodenticide that is effective against both rats and mice, including resistant strains. Storm is available as a 20 g block packed in 3 kg and may also be used in sewers and covered drains where their resistance to mould growth make them particularly suitable. Approved for Pulse baiting. IR(93137)

Approval No: UK-2015-0850

1 x 3 Kg

ORDER CODE: BSTBB003

£35.02

PROFESSIONAL

STORM® ULTRA SECURE



Contains 0.0025 % Flocoumafen. Storm Ultra is a highly effective new addition to the successful line of Storm® products. At least twice as palatable as leading anticoagulant block baits, Storm Ultra is stable and durable enough to withstand extreme temperatures. Storm Ultra features a patented formulation employing an innovative BASF binder with superior performance. Approved for pulse baiting and burrow baiting.

Approval No: UK-2018-1164-0001

1 x 3 Kg

ORDER CODE: BSTULTRA

£34.95

BRODIFACOUM

Read product label fully to understand the directions on use before application or treatment.

RODENT control

PRODUCTS

ROMAX® VENOM FRESH BAIT 29ppm



Romax Venom fresh bait is enclosed within a place-pack ready baiting format of 60 g with slug and snail resistant packaging. The packaging is designed to be pierced through the lid to diffuse the aroma into the surrounding area. Containing Brodifacoum, the most potent rodenticide anticoagulant available for very effective control at a concentration of 0.0029 %, thereby excluding the associated reprotoxic labelling and the 'may cause damage to the unborn child' phrases. Pulse baiting and burrow baiting approved. Approved for use indoors and outdoors (around buildings) as well as sewers. For professional use only. (50 x 60 g trays)

Approval No: UK-2015-0857-0007

1 x 3 Kg

ORDER CODE: BVENFR3K

£39.53

ROMAX®

Barrettine
Environmental Health

(CAS No. 56073-10-0)

ACTIVE SUBSTANCE: BRODIFACOUM 0.0029% (W/W)

VENOM

FRESH BAIT

IDEAL FOR USE IN ACCORDANCE WITH
RODENTICIDE STEWARDSHIP CONDITIONS



- ✓ The most potent anticoagulant rodenticide available.
- ✓ Below 30ppm Concentration. No reprotoxic effects.
- ✓ Approved for Pulsed Baiting for Rat & Mice.

ROMAX Venom fresh bait, the latest addition to the Barrettine rodent control range that complements the Venom loose wheat, Venom pasta sachet, Venom block and Venom Lipogel formulations. The Venom Fresh Bait is enclosed within a place-pack ready baiting format of 60g with slug and snail resistant packaging. The packaging is designed to be pierced through the lid to enable the aroma to diffuse into the surrounding area.

Available in a 3 Kg format.



PROFESSIONAL

ROMAX® VENOM BLOCK



Containing the most potent anticoagulant active ingredient, Romax® Venom is a ready-to-use 25 g wax block with 0.005 % (w/w) Brodifacoum for effective control of mice and rats. Rodents' death occurs after a few days (3 to 5) from a single feed without rousing suspicion towards the bait by the other members of the colony.

Approval No: UK-2015-0880-0003

1 x 5 Kg

ORDER CODE: BVBBROD5

£50.39

PROFESSIONAL

ROMAX® VENOM WHEAT



The Romax® Venom active ingredient is infused within the core of the seed, giving a product and active, that when consumed is particularly potent to rodents. Approved for use 'in and around buildings' for rats and mice.

Approval No: UK-2015-0883

1 x 4 Kg

ORDER CODE: BVWBRD4K

£30.09

1 x 10 Kg

ORDER CODE: BVWBRD10

£55.23

PROFESSIONAL

ROMAX® VENOM PASTA SACHET



The Romax® Venom formulation of Brodifacoum made with Italian pasta is presented in sachets that can be attached or skewered within the bait box. Approved for use 'in and around buildings' for rats and mice.

Approval No: UK-2015-0881-0001

1 x 3 Kg

ORDER CODE: BVPBROD3

£30.24

PROFESSIONAL

ROMAX® VENOM LIPOGEL



The Romax® Venom Lipogel combines Brodifacoum within an increased water activity formulation offering rapid efficacy and the convenience and capacity of rapid baiting. The availability of Brodifacoum in this format gives rapid absorption into soft tissues. For use 'in and around buildings' for rats and mice.

Approval No: UK-2016-1041-0002

10 x 300 g

ORDER CODE: BVLIPBRD

£120.60

ROMAX®

Barrettine
Environmental Health

(CAS No. 56073-10-0)
CONTAINS BRODIFACOUM 0.005% (W/W)

VENOM Range

IDEAL FOR USE IN ACCORDANCE WITH
RODENTICIDE STEWARDSHIP CONDITIONS

FIVE FORMULATIONS

ROMAX®
VENOM
PASTE

UNIQUE
LIPOGEL BAIT

- ✓ High Water Activity
- ✓ Rapid Absorption into Soft Tissue
- ✓ Controls Rats & Mice
In and Around Buildings

The Romax Venom Lipogel combines Brodifacoum within an increased water activity formulation offering rapid efficacy as well as the convenience and capacity of rapid baiting. The availability of this range includes five products: **Lipogel, Wheat, Pasta, Block** and the new **Fresh Bait** formulation. The expansion combines the potency of Brodifacoum within the range of several formulations giving professionals the selection and scope to control rats and mice both in and around buildings.



Unit 4 Caxton Business Park, Crown Way, Warmley, Bristol BS20 8XJ.
Tel: 0117 967 2222 Fax: 0117 961 4122 Email: beh@barrettine.co.uk www.barrettineEnv.co.uk
USE BIOCIDES SAFELY. ALWAYS READ THE LABEL AND PRODUCT INFORMATION BEFORE USE.



PROFESSIONAL

SOLO 20 g BLOX

IR



Standard 20 g size bait block for rat and mouse control that fits into most bait stations. Highly palatable formula with hard ridges that appeal to rodent gnawing behaviour. IR(94279)

Approval No: UK-2015-0905

1 x 4 Kg

ORDER CODE: BSOLBL20

£52.39

PROFESSIONAL

SOLO 200 g SUPER BLOX

IR



A large 200 g block ideal for use in sewers or against heavy rodent infestations. IR(95990)

Approval No: UK-2015-0905



1 x 10 Kg

ORDER CODE: BSOLSB20

£150.22

KNOCKOUT® WHEAT SACHET 29ppm



A highly palatable ready to use grain formulation for the control of rats and mice. Authorised for 'Non-Certified' users. Contains Brodifacoum 0.0029 % (w/w). Proven to be a fast and effective rodenticide.

Approval No: UK-2015-0895

24 x 150 g

ORDER CODE: BKNOCKSA

£36.09

PROFESSIONAL

TALON PELLETS



An extremely palatable pellet formulation that is suitable for use in urban and rural situations.

Approval No: UK-2015-0908-01

1 x 10 Kg

ORDER CODE: BTALP8KG

£88.85

BRODIFACOU M

PROFESSIONAL TALON WAX BLOCK



The high palatability encourages sufficient consumption for the single-feed kill. Talon wax 20 g blocks are manufactured with a fine particle matrix of ground high-quality cereal grain.

Approval No: UK-2015-0907-0001

1 x 5 Kg ORDER CODE: BTALWB25 £73.39

PROFESSIONAL TALON SOFT BAIT



Available in a 300 g tube and is a paste-like formulation delivered via a standard caulking gun. It remains palatable in a variety of temperatures and environments and is ideal for sensitive areas, such as food processing or storage areas.

Approval No: UK-2015-0910

12 x 300 g ORDER CODE: BTALSB30 £153.66

ALPHACHLORALOSE

Single feed indoor rodenticide registered for mice. The active ingredient has anaesthetic and sedative properties.

PROFESSIONAL ALPHA EXPRESS BLOCKS



Alphachloralose is an acute-acting active substance that has been newly formulated and especially designed for use in tamper-resistant bait boxes. For fast and effective control of mice indoors in a wide variety of locations. Only a small scratch from a mouse's incisors on the block's surface is sufficient, and just 'sampling' of the bait is often enough to kill.

Approval No: UK-2013-0803

48 x 5 g ORDER CODE: BALPHBLX £33.59

ROMAX® DRAIN TRACING DYE

Non-toxic organic dyes and, where possible, are made from food-grade or similar concentrates.



1 x 200 g Blue	ORDER CODE: BTRDYEBL	£10.60
1 x 200 g Green	ORDER CODE: BTRDYEGR	
1 x 200 g Red	ORDER CODE: BTRDYERE	
1 x 200 g Orange	ORDER CODE: BTRDYEOR	
1 x 200 g Yellow	ORDER CODE: BTRDYEYE	
10 x 20 g Orange Sachet	ORDER CODE: BTRDORSA	£14.70

ROMAX® FLUORESCENT TRACKING DUST

A rodent detector system that uses tracking dust that fluoresces in "black light" (ultraviolet).



1 x 250 g Yellow	ORDER CODE: BTRDU250	£23.13
1 x 1 Kg Yellow	ORDER CODE: BTRDU001	£80.76
1 x 250 g Blue	ORDER CODE: BTRDUB25	£23.13
1 x 250 g Pink	ORDER CODE: BTRDUP25	£23.13

UV TRACKER TORCH

Ideal for use with tracking dusts, non-toxic fluorescent baits and fluorescent rodenticides.



Each	ORDER CODE: BUVTLAMP	£22.47
------	----------------------	--------

PROFESSIONAL DEADLINE TRACKING GEL

PROFESSIONAL



Deadline® Fluorescent Tracking Gel for rats and mice. The gel can be used on horizontal and vertical surfaces. To aid visibility, use a UV torch to highlight rodent track marks.

Professional Use Only.

1 x 300 ml	ORDER CODE: BDEADGEL	£17.06
------------	----------------------	--------

MONITORING & INDICATOR PRODUCTS

RODENT control

PRODUCTS

RODENT CONTROL - MONITORING & INDICATOR PRODUCTS

DETEX BLOX WITH LUMITRACK



Reformulated using Lumitrack, droppings glow bright green under UV light. Highly palatable non-toxic monitoring bait. There is now a demand from food manufacturers and large industrial businesses to monitor constantly for rodents with non-toxic bait. Detex Blox fits perfectly into this situation. The new Detex Blox from Bell contains a fluorescent marker which glows under UV light to aid with tracking infestations.

Standard outer 2

1 x 4 Kg

ORDER CODE: BDEBX004

£25.22

DETEX SOFT BAIT WITH LUMITRACK



Detex Soft Bait incorporates Lumitrack; a special additive that causes rodent droppings to brightly glow under UV or black light. This tool helps professional pest controllers identify droppings in dark or congested areas where they would normally go unnoticed. Rodent droppings help identify species type and track rodent activity (i.e. entry points, pathways and harbourage areas). Lumitrack® takes the guesswork out of rodent control and improves your baiting strategy.

Each 15g sachet of Detex Soft Bait includes an extruded hole in the centre, making it easier for the professional pest controller to place the bait onto the rod and allowing it to be placed more consistently and securely. Detex Soft Bait has been specially developed to achieve sustained palatability, making it ideal for long-term applications

1 x 3.6 Kg

ORDER CODE: BDEBXSBL

£44.54

HARMONIX MONITORING PASTE



Harmonix Monitoring Paste is a new non-toxic monitoring bait. With its full traceability day and night, it is also free from the big eight food allergens including wheat and is HACCP certified; making it suitable for use within the food industry. It is the first essential step in integrated pest management for use for early detection of rodent activity and to encourage bait acceptance ahead of treatment.

1 x 5 Kg

ORDER CODE: BHARMON5

£26.33

DEADLINE NON TOXIC PASTE



A very attractive, poison-free, wheat-based paste to test for the presence of rodents. Based on the same base as Deadline Bromadiolone and Difenacoum paste to allow for later introduction of poisons with no change in taste.

1 x 300 g

ORDER CODE: BDEADNTP

£4.22

ROMAX® RODENT BAIT BOX



The Romax® rodent bait station is a high-quality, tough, injection moulded bait box. The Romax® rodent bait station features our unique locking mechanism, making it an ideal solution for internal and external baiting using bait blocks, grain or wheat, pasta sachets and paste/gel. Romax® rodent bait stations can also be used with physical control methods such as Snap traps etc. Own branding available; contact the office for further information.

From £6.64 per box.

BUY 3 GET 1 FREE
25% OFF

1 x 12	ORDER CODE: BBBRSTD	£79.63
Spare Metal Bar	ORDER CODE: BPINBARS	£0.78 Each

ROMAX® METAL & PLASTIC BAIT BOX KEY



METAL - Heavy duty metal key for use with Romax® rat bait boxes. Can also be used with Romax® mouse boxes.

PLASTIC - Replacement bait box keys for use with Romax® rat and mouse bait boxes.

Each - Metal	ORDER CODE: BBBRKEYM	£1.64
Each - Plastic	ORDER CODE: BBBRTKEY	£0.43

ROMAX® BAIT TUBE



A bait station system that allows you to check & refill without handling the station. (145 mm x 94 mm x 31 mm deep).

Each	ORDER CODE: BBBRATEY	£7.50
------	----------------------	--------------

PROTECTA EVO CIRCUIT



The Protecta EVO Circuit Station utilise a proprietary single lock design, removable tray for quick service, and proven dog and child tamper-resistance. To aid in its disguise, simulated connectors slide into the sides of the EVO Circuit, making it appear as an electrical box.

1 x 6 (Black)	ORDER CODE: BBBEVOCI	£55.38 While stocks last
1 x 6 (Grey)	ORDER CODE: BBBEVCIG	£56.42
Bait Box Key	ORDER CODE: BPEVOKEY	£2.29

RODENT BAIT STATIONS

PROTECTA EVO LANDSCAPE



The Protecta Evo Landscape tamper resistant bait box from Bell Lab's. A novel textured rock shaped bait station that will easily blend in with outdoor landscapes. Available in two realistic colours, sandstone and granite. Made from heavy-duty injection moulded plastic to withstand frequent servicing. Now with improved an Evo lock system.

1 x 4 (Sandstone)	ORDER CODE: BBBPRLAS	£60.61
1 x 4 (Granite)	ORDER CODE: BBBPRLAG	£61.46
Bait Box Key	ORDER CODE: BPEVOKEY	£2.29

PROTECTA EVO AMBUSH



The Protecta EVO Ambush Station utilise a proprietary single lock design, removable tray for quick service, and proven dog and child tamper-resistance. Even with its low-profile design, the EVO Ambush still allows room for the Trapper T-Rex snap trap.

1 x 6	ORDER CODE: BBBEVOAM	£37.83
Bait Box Key	ORDER CODE: BPEVOKEY	£2.29

PROTECTA SHIELD



The Protect Shield bait box combines a durable and robust design with a single-locking mechanism and side opening lid for fast and efficient service. The locking bait rods secure bait while the rounded interior walls offer an easy clean-up. The compact size offers versatility with bait station placement and a capacity that can hold three of the 28 g bait BLOX or soft bait.

1 x 12	ORDER CODE: BBBPROSH	£51.65
Bait Box Key	ORDER CODE: BPEVOKEY	£2.29

PROTECTA EVO EXPRESS BOX (WEIGHTED)



The Evo rodent box from Bell is made from 100% recycled, heavy-duty injection-moulded plastic. A new symmetrical key self-oriens into the lock. The ramped entry allows bait to stay dry in water-prone areas, and the Bell barcode sticker is pre-installed for those with tracking software. Comes with weighted blocks to anchor bait station securely.



1 x 2 (Weighted)	ORDER CODE: BBBEVOEW	£26.20
1 x 4 (Unweighted)	ORDER CODE: BBBEVOEX	£39.33
Bait Box Key	ORDER CODE: BPEVOKEY	£2.29

NEW

PROTECTA EVO TUNNEL



The new Protecta® Evo® Tunnel™ is an economical and versatile way to protect traps at accounts. Protecta® Evo® Tunnel™ can be used indoors or outdoors, and can be secured to fences or pipes via cable ties in both the vertical and horizontal position. A low and discreet profile, the Evo Tunnel provides tamper-resistant coverage of a variety of rat and mouse traps. Protecta® Evo® Tunnel™ accommodates two Trapper® T-Rex® rat snap traps, which are secured into the Evo Tunnel base. The Evo Tunnel also can also provide cover for mouse-sized products such as two Mini-Rex mouse snap traps, two Trapper® Mouse glue trays or two Trapper® Max glue boards. Protecta® Evo® Tunnel™ opens and locks quickly with Bell's Evo key, and Evo Tunnel stations are stackable for easy handling.

1 x 6

ORDER CODE: BBBETUNN

£51.43

PROTECTA HD RAT BAIT STATION



A reusable lockable item in heavy-duty black plastic. Holds more than 500 g of bait. It can also be used for water baits.

1 x 6

ORDER CODE: BBBPRRBS

£48.49

Bait Box Key

ORDER CODE: BPROTKEY

£0.80

PROTECTA SIDEKICK



The Protecta Sidekick from Bell Lab's has a high profile lid with a baiting capacity of up to a 1 Kg of bait. Break back traps such as the T-Rex can also be used when rodenticide is not an option. The sidekick has been priced so that you can offer your cost-conscious accounts an excellent quality bait box at a very competitive price.

1 x 6

ORDER CODE: BBBPRSDK

£34.02

Bait Box Key

ORDER CODE: BPROTKEY

£0.80

PROTECTA LP RAT BAIT STATION



A low profile station angled to fit corners. Lockable, holds up to 500 g bait.

1 x 6

ORDER CODE: BBBPRLPS

£38.33

Bait Box Key

ORDER CODE: BPROTKEY

£0.80

RODENT BAIT STATIONS

RODENT BAITER RAT

A rigid thermoformed plastic unit which can accommodate dry or liquid baits (2 piece).



1 x 24	ORDER CODE: BRODRABA	£61.38
--------	----------------------	--------

QUICKLOCK DURABAIT

Small footprint but large internal capacity with lift-out bait liner for servicing. Compact stainless steel locking mechanism designed to be unaffected by dirt and debris and accommodates break back traps, block & loose bait. The Station can either be fixed directly to the floor through holes in the base, secured directly to a wall using a fixing bracket or secured with a ground stake. Available in Black or green.



Each (Black)	ORDER CODE: BDURBAIT	£6.82
Each (Green)	ORDER CODE: BGRDBAIT	£6.23
Spare Versa Key	ORDER CODE: BVERSKEY	£2.00

ROGUARD™ XTRA RAT BOX

Roguard Xtra has a number of improvements such as dust caps for the locks, bars for rodenticide blocks that can be used either vertically or horizontally. Boxes also stack inside each other for ease of carrying, making this a very versatile bait station.



1 x 12	ORDER CODE: BBROG300	£86.45
--------	----------------------	--------

MINT
EXCLUSIVE MEMBERSHIP

Mint Members enjoy
UP TO
20% OFF
PLUS PROMOTIONAL SAVINGS

ULTRABAIT VR RAT BAIT STATION



A unique all-in-one vandal resistant robust lockable bait station made from heavy gauge steel casing. Features include: Nine rivet lock, Lift-out plastic liners, optional hardened steel vandal proof fixing bracket. Own branding available; contact the office for further information.

Each (Dark Grey)	ORDER CODE: BBBULTVR	£21.74
Each (Green)	ORDER CODE: BBBULTVG	£21.74
Key	ORDER CODE: BBBPRKEY	£2.56
STD (Fixing Bracket)	ORDER CODE: BBBPRBRA	£0.91
Vandal Proof (Fixing Bracket)	ORDER CODE: BBBULBRV	£4.18
Ultrabait Bars	ORDER CODE: BPCFIBAR	£1.78

PREMIER GROUND ANCHOR

A simple but strong and effective ground anchor for use with the Rat Bait Stations.

Each	ORDER CODE: BBBPRGRA	£3.57
------	----------------------	-------

QUICKLOCK ULTRA



Features a superior stainless steel locking mechanism for consistent, secure operation with hinged end opening with top key entry offers excellent servicing speed. The product accommodates break back traps, block or loose bait. The Station can either be fixed directly to the floor through holes in the base, secured direct to a wall using a fixing bracket or secured with a ground stake. Available in Black or green.

Each	ORDER CODE: BQKULTRA	£21.74
Spare Versa Key	ORDER CODE: BVERSKEY	£2.00

Save time, place your order any time.

PAY ONLINE

BarrettineEnv.co.uk



BOX CLEVER

ROMAX[®] Mouse Box
offering great value in today's market.

- Optional inbuilt insect monitor
- An advanced securing system for bait
- Unique company logo personalisation
- Single key for the complete range
- Available in a variety of colours



ROMAX® MOUSE BOX



Standard pallet of 100



BUY 4 GET 1 FREE
20% OFF

Available in a variety of colours.



1 x 24	ORDER CODE: BBBROMOU	£POA
Bait Box Key	ORDER CODE: BBBRTKEY	£0.43

ROMAX® INSECT 'FLOOR'

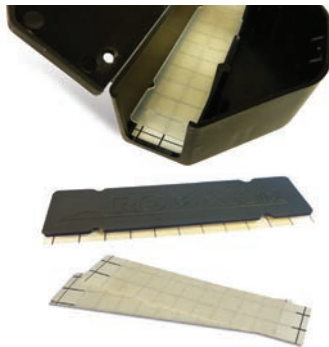

A unique false floor designed to fit in the entrance to the Romax® mouse box. The clever design allows a pre-baited insect monitor to be placed underneath, and insects can be detected underneath whilst the mice walk over the top to the bait. Independently tested to catch insects up to the size of an oriental cockroach and available in black or clear (or bespoke!)

1 x 24 (Black)	ORDER CODE: BBBROMFL	£5.28
1 x 24 (Clear)	ORDER CODE: BBBROMFC	£4.28
1 x 100 Sticky Pads	ORDER CODE: BBBROMIM	£15.90

PROTECTA EVO EDGE

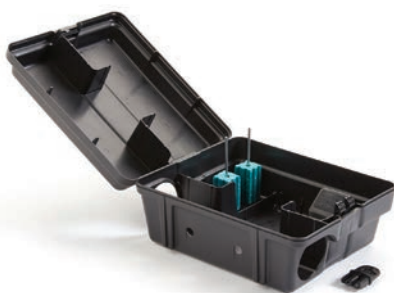

Protecta Evo Edge is a versatile rodent bait station that is easy to use and service. The station opens and locks quickly with Bell's Evo key. The built-in service record card holder, side-opening design and rounded interior walls make servicing fast, maximizing technician productivity. The station has a large bait capacity holding up to eight 28 g or four 225 g Blox securely inside the station and comes with vertical securing rods. Designed for more than just bait, Protecta Evo Edge also accommodates two Trapper Mini T-Rex mouse snap traps, or Trapper T-Rex rat snap trap be set forward in the runway.

1 x 6	ORDER CODE: BBBEEDGE	£29.00
-------	----------------------	--------

PROTECTA MOUSE



The Protecta Mouse is also known as the "sidewinder" because it opens like a book, making it easy to service when the bait station is flush against the wall. You can use it with loose bait and bait blocks, or for non-toxic control you can fit the Trapper snap trap neatly inside.

1 x 12	ORDER CODE: BBBPRMOU	£34.10
--------	----------------------	--------

MOUSE BAIT STATIONS

PROTECTA RTU MOUSE BAIT STATION



The highest quality bait box available. A reusable lockable item in heavy-duty black plastic. Designed to fit into corners or on straight walls.

1 x 12

ORDER CODE: BBBRUMBS

£18.42

RODENT BAITER MICE

A rigid thermoformed plastic unit which can accommodate ready-to-use baits (2 piece).



1 x 50

ORDER CODE: BRODMOBA

£61.37

PROTECTA MICRO MOUSE BAIT STATION



A quality mouse box from Bell Labs with an incredible budget price. The micro uses the same sturdy metal key employed by the rest of the Bell range, and its size allows for discrete baiting.

1 x 12

ORDER CODE: BBBPRMIC

£7.96

PROTECTA EVO MOUSE BOX



The Protecta Evo Mouse bait station has been designed with the pest controller in mind and opens with the quick entry Evo lock for fast servicing. Bell has maintained the high quality it has through the Protecta range with this station and has included patent-pending internal teeth clamps in the station so it can clamp bait inside to prevent displacement. The triangular design allows the station to be placed against walls or in corners, and is suitable for internal or external use.

While stocks last.

1 x 12

ORDER CODE: BBBEVOMO

£15.66

MICRO BAIT STATION

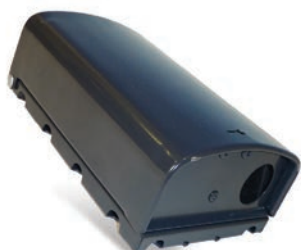

A smaller version of the leading Ultrabait VR, the micro bait station is a vandal-resistant lockable bait station made from heavy gauge steel casing. Using the same key, the box is ideal for those mice jobs where a heavy-duty and/or permanent station is required (150 x 105 x 57 mm).

Each	ORDER CODE: BBBPMSTB	£5.86
Bait Box Key	ORDER CODE: BBBPMSKE	£1.67

QUICKLOCK MICROBAIT



Tamper-resistant mouse bait station. Steel locking mechanism for consistent, secure operation with hinged side opening for excellent servicing speed. Insect monitor also available.

Available in a variety of colours - black, blue, green, red and white.

Each	ORDER CODE: BGKMICRO	£0.91
Spare Versa Key	ORDER CODE: BVERSKEY	£2.00

ROMAX® CARDBOARD BAIT BOX



For mouse baits. Heavy-duty board, internally and externally laminated for water resistance. Own branding is available, call the office for further information.

1 x 100	ORDER CODE: BBBCARDB	£16.97
---------	----------------------	--------

KEY SET



A key set for opening the following rat bait boxes.

- Rentokil External Bait Box Key - Code: BREXBKEY
- Romax® Metal Bait Box Key - Code: BBBRKEYM
- Protecta Evo Bait Box Key - Code: BPEVOKEY
- Protect Bait Box Key - Code: BPROTKEY
- UltraBait Bait Box Key - Code: BBBPRKEY
- Versa / Durabait Bait Box Key - Code: BVERSKEY
- SX Bait Box Key - Code: BSXKEYSI

Each	ORDER CODE: BUNCHKEY	£14.28
------	----------------------	--------

INTERNAL BAIT BOX FIXINGS

ROMAX® BAIT BOX ANCHORS



Bait box fixing points. Industrial strength adhesive pads allow bait boxes to be fixed with wire (not supplied) to walls without the need for drilling or adhesives.



1 x 100

ORDER CODE: BBBROMCL

£23.08

CABLE / ZIP TIES



Standard cable/zip ties 200 mm long x 4.8 mm wide. Useful sundry items to carry around for tying/fixing things into place with great ease and speed. Other sizes are available please contact the office.

1 x 100

ORDER CODE: BZIPT100

£6.00

BAIT BOX ANCHOR KITS



Bait box fixing point with industrial-strength adhesive and wire for ease of installation. Option with clip so that boxes can be removed for servicing then re-installed.

1 x 10
(without clip)

ORDER CODE: BBBANKIT

£14.15

1 x 10
(with clip)

ORDER CODE: BBBANKCL

£17.02

PLASTIC BAIT TRAYS



Thermo-formed moulded plastic - (Approximate dimensions)

RED - Medium oblong (100 mm x 115 mm x 26 mm deep).

WHITE - Large oblong (150 mm x 220 mm x 38 mm deep).

1 x 100
(Red)

ORDER CODE: BBBTRMED1

£7.60

1 x 100
(White)

ORDER CODE: BBBTRLGE1

£12.40

NEW

ELECTRONIC RAT & MOUSE TRAP



Large trap suitable for rats and mice.
 Secure and rapid death from electrocution.
 Very economical electric rat trap / mouse trap.
 This electric rat and mouse killer quickly and humanely kills pests through electric shock.
 The device is safe to use (CE approved) and works with the supplied adapter or 4 batteries * (not included).
 You can remove the trapped rat or mouse without having to touch it with your hands, which is hygienic.
 This device is not suitable for outdoor use.
 Easy to clean because the top part can be clicked off. With LED indication.

Each

ORDER CODE: BTRELTRA

£20.20

We've made it
SUPER EASY
 TO ORDER & PAY ONLINE

NEW
 2021



THE BENEFITS

- Order, pay and complete the process in one go.
- User friendly experience with improved navigation.
- Fresh content with the latest products and promotions.
- Save time and place your order anywhere any time.

It's super easy to sign up and enjoy our benefits.

www.barrettineEnv.co.uk

SENSOR TECHNOLOGY

RODENT CONTROL - SENSOR TECHNOLOGY

ROMAX® CUBE

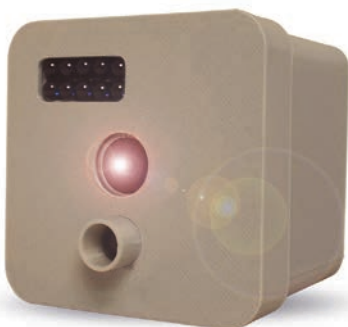

The Intelligent Motion Sensor Technology for Professional Pest Controllers.

The primary function of the Romax® Cube in a trapping application is to report when a trap has been activated. In commercial applications, this will save many hours travelling time that can be consumed by:

- A) Checking if traps have been activated, or
- B) To determine whether pests are present.

The Romax® Cube is effective in real-time alerting of activated traps and real-time photographic evidence of the presence of pests. This information optimises a technician's daily planning schedule, thereby lowering operational costs.

Should a trap be activated or a pest be photographed near a trap, the technician will receive an alert to their smartphone within 60 seconds.

One Romax® Cube can monitor up to 10 traps (movement tags) within a 50 metre range in a clear view of sight. The Romax® Cube uses a cross-network SIM and the 2G cellular network, which means it works in the most remote locations.

Romax® Cube Day & Night	ORDER CODE: BCUBEDAN	£331.29
Romax® Cube Carry Case	ORDER CODE: BCUBCASE	£9.29
Bluetooth Sensor (Hook)	ORDER CODE: BTAGHOOK	£31.00
Enclosure (Waterproof)	ORDER CODE: BWATCADN	£40.60

TRACK & RECORD ACTIVITY VIA MOBILE APP

MULTIPLE SENSORY PLACEMENTS (UP TO 10 SENSORS)

MONITOR TRAPS VIA BLUETOOTH REMOTELY TO SAVE YOU TIME

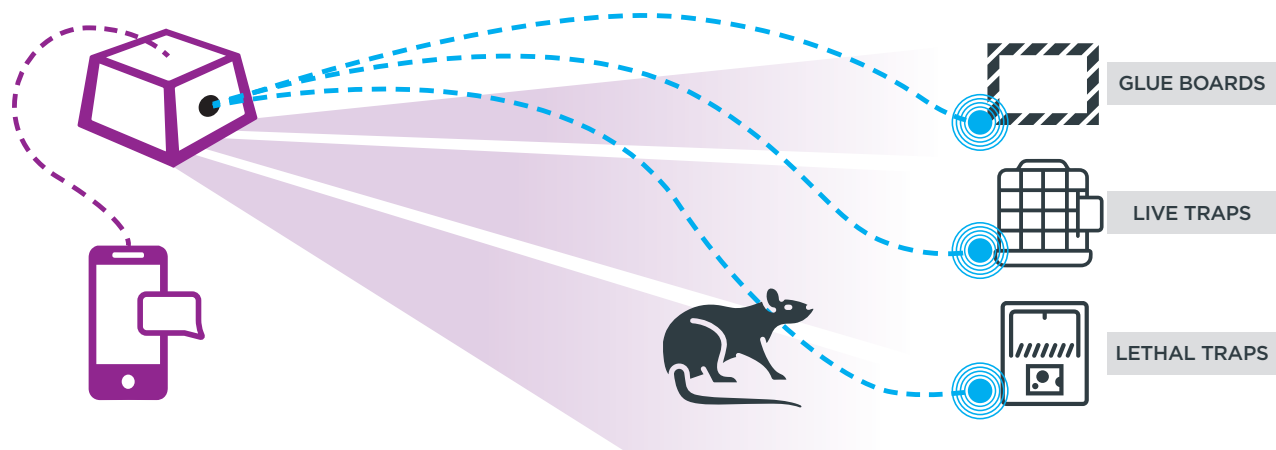

ROMAX® E-TRAP

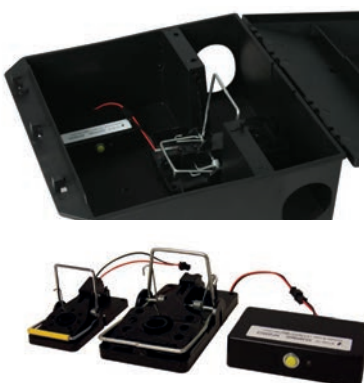

The latest in electronic switch technology: Remote monitoring for both rat and mouse traps. Unit consists of a remote monitoring system that sends a message to your smartphone when a trap is triggered. This alert allows the user to schedule visits to premises once traps have been triggered to remove the rodent and reset the traps. Multiple traps can be set via the control module. Ideal device to increase the daily productivity, customer visits and rodent control success rates.

- Rat System (one trap per box)
- Mouse System (two traps per box)

Rat System	ORDER CODE: BETRPRAT	£62.12
Mouse System	ORDER CODE: BETRMOU	£62.46

ROMAX[®] CUBE

Be Smart

Intelligent Motion Sensor Technology

Intruder Activity

instant alerts to your smartphone

Giving you peace of mind for monitoring and security applications.

Monitoring uses for:

Pest Traps



Domestic/
Commercial
Premises



Commercial
Vehicles

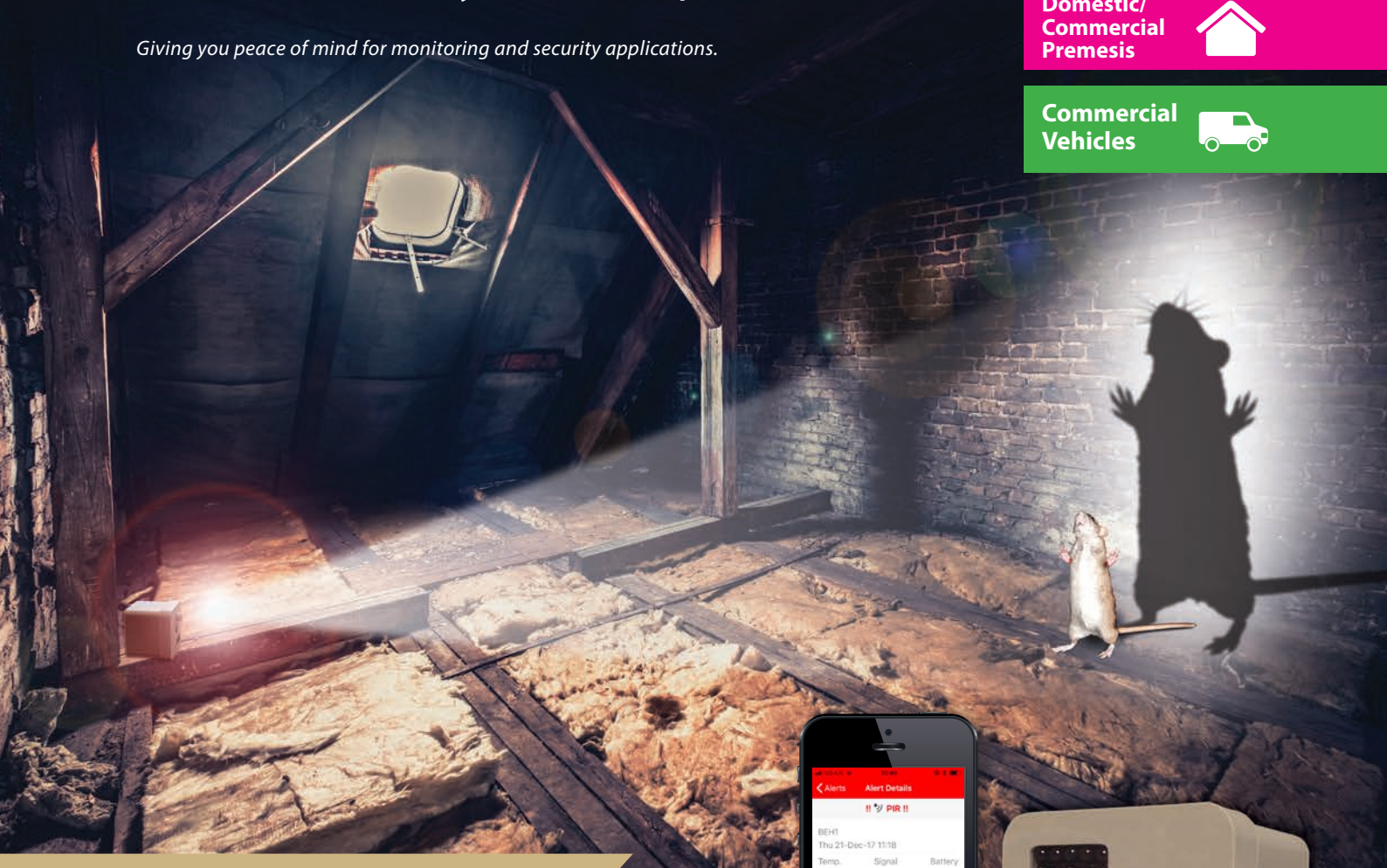

The Romax[®] Cube Features:

- ✓ One Romax[®] Cube can monitor up to 10 traps (movement tags) within a 50 metre range.
- ✓ Passive Infrared Detector (PIR) sensor- detects any movement within a 135 degree angle.
- ✓ High resolution Camera, date and time stamped photos once movement is detected.
- ✓ Bluetooth 'movement sensor tags' – if traps have been activated you will be sent a real-time alert within 60 seconds.
- ✓ GPS location- the alert from the Romax[®] Cube, including the trap's, can be forwarded to colleagues who might be better placed to attend.
- ✓ The Romax[®] Cube uses a cross network SIM and the 2G cellular network, working in the most remote locations.

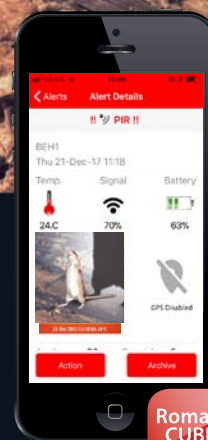

Romax[®]
CUBE
APP



Romax[®] Cube dimensions:
10cm x 10cm x 10cm

SNAP & LIVE CATCH TRAPS

ROMAX® SNAP-R MOUSETRAP

The new Romax® Snap-R mouse trap combines an effective mousetrap mechanism with rugged materials, the Snap-R is simple, durable and effective. Please note colour of strike bar may vary.



BUY 8 GET 2 FREE
20% OFF

Each

ORDER CODE: BSNAPMTR

£1.56

ROMAX® SNAP-R RAT TRAP

The Romax® Snap-R Rat Trap is highly effective at trapping rats. Detachable tag allows traps to be secured if required.



BUY 8 GET 2 FREE
20% OFF

Each

ORDER CODE: BSNAPRTR

£3.26

VICTOR CLEAN KILL TUNNEL MOUSE TRAP

The Victor Clean Kill Tunnel design increases interaction with the mouse. Once the mouse enters the trap to retrieve the bait, the Kill-Gate enables perfect placement for a quick, humane kill. No-see, no-touch tunnel design. No chemicals or poisons, safe to be used around children and pets. The trap is reusable or disposable.



1 x 2

ORDER CODE: BVICTUNL

£5.37

VICTOR KILL VAULT MOUSETRAP

The Victor Kill Vault is similar to the Hidden Kill from Bell - however, it is resettable, use in conjunction with our ROMAX® Rodent Feed Paste. This mouse kill trap contains the dead mouse, and you can drop the carcass in the bin and reset it for multi-use. This is the same technology as the Victor clean kill - however, the mouse is completely hidden when the trap goes off (No tail hanging out the end). Ideal as a sell on / for use in domestic and offices for mouse control.



1 x 2

ORDER CODE: BMOUM267

£4.29

HIDDEN KILL MOUSE TRAP



The Hidden Kill has several unique features that combine a quick, no mess capture and kill with exceptional value. The two-way entry allows mice to enter from either direction and the fully enclosed capture area keeps the captured and despatched mouse hidden inside. The design allows an easy "no-touch" disposal.

The Hidden Kill trap is to be used with Provoke mouse.

1 x 24	ORDER CODE: BHIDTRAP	£37.01
--------	----------------------	--------

VICTOR RAT & MOUSE TRAPS

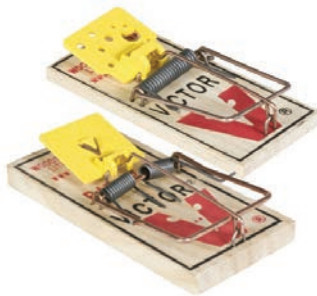

The original break-back traps. Widely used and preferred by many pest control technicians. Heavy-duty spring for large rats ensuring clean kill.

1 x 12 (Rat Traps)	ORDER CODE: BRATM326	£26.59
1 x 30 (Mouse Traps)	ORDER CODE: BMSEM325	£26.52

TRAPPER T-REX



The Trapper T-Rex from Bell is a powerful trap that has many features. It comes with aggressive interlocking teeth and a removable bait cup for safer baiting. The trap can be easily set by either foot or hand and fits into various rat bait stations.

Standard outer 12

Each	ORDER CODE: BTRT-REX	£5.43
------	----------------------	-------

TRAPPER MINI-REX



The Trapper Mini-Rex from Bell is a powerful mouse trap with aggressive interlocking teeth and a removable bait cup for safer baiting. The trap can be easily set by either foot or hand and fits into various rat bait stations.

1 x 24	ORDER CODE: BTRTMREX	£37.80
--------	----------------------	--------

SNAP & LIVE CATCH TRAPS

TRAPPER PEST MONITOR



Trapper Pest Monitor is a reusable, plastic station used with Trapper MC Glue Trap to monitor both insects and mice.

For monitoring insects and mice, place a TRAPPER MC Glue Trap in the base, using the clips to hold the glue trap firmly in place. Insects can access Pest Monitor from holes on all four sides. Mice enter through the two larger holes that are adjacent to the wall. To prevent mice from accessing Pest Monitor, rotate the top, covering the two larger holes.

1 x 12

ORDER CODE: BBBPRPEM

£36.62

TRIP-TRAP



A single live catch mouse trap. A simple one way door that allows entry but no exit. The end section can be removed to place food and take out the trapped mouse.

1 x 6

ORDER CODE: BTRTRIPT

£15.90



ROMAX® RODENT FEED



Contains a highly effective seed substance formulation in a convenient 55 ml syringe container to load both live and lethal traps. This paste formulation allows easy application and effective grab onto the trap's trigger plate to enhance catch rate. Ideal for use in food premises as this product does not contain nuts. To be used by professionals who have gel style syringe gun applicators.

Each

ORDER CODE: BRODFEED

£7.78

PROVOKE MOUSE & RAT



Developed by Bell scientists, Provoke is specifically formulated for rats or mice. Provoke is a food-based matrix targeted specifically to the feeding preferences of mice.

Mouse - Each

ORDER CODE: BPROVOKE

£4.41

Rat - Each

ORDER CODE: BPROVRAT

£17.92

TRAPPING GUIDELINES FOR RODENTS

Whilst the use of traps is labour intensive, they have a part to play in rodent control, particularly for controlling very small infestations in circumstances where the use of rodenticides is unacceptable. They are unlikely to contribute significantly to large scale control programmes. The major reason for their limited applicability is the behaviour known as neophobia. If large scale control using traps is essential, then the trapping programme needs to be very intensive and very closely monitored.

The use of break-back traps for both rats and mice is probably the most widespread and successful trapping technique. Careful placement is required with break-back traps, the treadle end of the trap being placed across the rodent run against a vertical surface to minimise avoidance. Bait does not need to be used and may reduce the effectiveness of the trap.

All traps should be visited at least once every 24 hours to remove any dead rodents, reset the traps, and ensure that no rodents are being held alive.

One further form of trapping is the use of 'Sticky-boards'. These are sheets of material, such as hardboard or plastic, on which a specially designed sticky substance or 'rodent glue' is spread. The boards are placed in areas of rodent activity in the hope that animals will become stuck on the boards and can then be humanely killed and removed.

Rodent boards should only be regarded as a 'last choice' option.

The new 'Alliance' Code of Practice on the responsible use of this technique can be found in the glue board section.

SPRING TRAPS GENERAL USE

The law requires that spring traps must be set in natural or artificial tunnels, to reduce the risk of killing non-target species. Natural tunnels such as burrows roots may be used, or artificial tunnels, about 60 cm long, can be made from turf, rocks, pipes, boards or fallen timber. This tunnel must be large enough to allow the trap's arms to swing and close, but the tunnel entrance should be reduced to a width of suitable size for the target species by driving sticks into the ground, to exclude pets and other wild mammals and birds. Squirrels will investigate such tunnels and catches may be made throughout the year, particularly in winter and spring. Baiting is unnecessary but will improve catches.

Traps should be placed with the trigger in the middle of the tunnel and should be bedded in flush with the floor. They should be inspected daily and sprung once a week to prevent seizing due to rust. All traps should be securely anchored.

The Spring Trap Pests Act 1954 makes it an offence to use a spring trap for the purposes of killing or taking animals in England and Wales other than one approved by an Order of the Secretary of State. The approval of traps is a devolved issue.

Traps that are currently approved in England are specified in the latest version of The Spring Traps Approval Order 1995. Only traps that have been approved for the purpose may be used.

Those commonly available from Barrettine are the Fenn MK4 & MK6, the Springer No 4 and No 6, Magnum 110 & 116 & Kania 2000 may also be used if available. Spring traps should not be used in areas where protected species such as red squirrels or polecats may be present.

MAGNUM SPRING TRAPS

BMI BODY GRIP 110 & 116 TRAP



These should not be used where they might take non-target animals. Recent refinements by BMI Magnum Series have made these traps even more effective to use. Every trap has a 4-way trigger that fires the trap when an animal pushes the trigger from any direction, including the side with a new trigger wire to control the strike area.

BMI BODY GRIP 110 TRAP

Target Species - rats, grey squirrel, weasel and stoat.

BMI BODY GRIP 116 TRAP

A larger version of the 110 above. Target species - mink, rabbit plus above species.

110 TRAP - Each

ORDER CODE: BTRMAGNU

£12.27

116 TRAP - Each

ORDER CODE: BTRMAG16

£14.25

BODY GRIP TRAP TUNNEL



It is recommended that this tunnel be used to ensure that non-target species do not have access to the trap. Manufactured in the UK with a plastic-coated finish to avoid corrosion.

Each

ORDER CODE: BTRMATUN

£20.30

WCS TUBE TRAP



The WCS tube trap is a self-contained unit considered to be safe setting, and it's power giving a humane, instant kill. WCS is approved under the Spring Traps Approval order 2009 for use against mink, squirrel, stoat and weasel & it's anti-rust plated finish makes it suitable for a variety of locations against mink, squirrel, stoat and weasel & its anti-rust plated finish makes it suitable for a variety of locations.

Each

ORDER CODE: BTRMTUBE

£70.66

Save time, place
your order any time.

PAY ONLINE

BarrettineEnv.co.uk



MOLE TRAP - SCISSOR TYPE 1

Effective for trapping moles. The trap is to be set in burrows with a round spring.



Each

ORDER CODE: BTRMOLSC

£9.56

MOLE TRAP HALF BARREL (DUFFUS)

A very popular trap for moles with good effectiveness in burrows.



Each

ORDER CODE: BTRMOLBA

£4.54

TALPEX® MOLE TRAP

Arguably the best mole trap on the market. Similar to the scissor and pincer traps but more robust. Steve Caple producer of the "Trapping Techniques" video confirmed the following; "Since switching to the Talpex trap my catch rate compared to the more commonly used traps has increased by at least 50 %".



Each

ORDER CODE: BTRMOTAL

£10.03

TALPIRID MOLE TRAP

An innovative method to catch moles from Bell Labs. Talpirid mole trap has a unique 'easy set' mechanism which reduces the chance of operator injury.

While stocks last.



Each

ORDER CODE: BTALPRID

£19.10

MOLE & SQUIRREL TRAPS

PUTANGE MOLE TRAP

Easy to use robust Mole trap. Each trap purchased will be accompanied by its trigger.



Each

ORDER CODE: BPUTANGE

£2.69

PUTANGE MOLE TRAP PLIERS

These pliers work in conjunction with the Putange Mole trap. The pliers allow you to set up the Putange Mole trap with ease and allow safer setting of the trap.



Each

ORDER CODE: BPPLIERS

£8.90

FENN TRAP MARK 4 & 6

FENN TRAP MARK 4

For squirrel, rat or stoat. The trap is to be set in runs or burrows. A artificial surround or tunnel should be created around the trap to protect non-target species.

FENN TRAP MARK 6

A larger version that will cope with rabbit and mink. The same setting conditions as that of the Fenn Mk4.



Mark 4 - Each

ORDER CODE: BTRAFEN4

£8.63

Mark 6 - Each

ORDER CODE: BTRAFEN6

£10.66

ROMAX® GREY SQUIRREL FEED



Romax® Grey squirrel feed is a non-toxic food grade feed made from seeds. It is highly attractive so ideal for use with live capture and kill traps. Control of squirrels should be undertaken outside of the squirrel breeding season. This feed can also be used for baiting rat and mouse traps.

Each

ORDER CODE: BRGRSQAT

£8.79

FERAL PIGEON TRAP

A live catch trap constructed using square galvanised mesh. Entrances with easy swing bob wires and top access for removing captured birds. Comes flat packed and complete with vinyl base for easier pre-baiting etc (not shown).



Each	ORDER CODE: BTRA029	£108.21
------	---------------------	---------

FOLDING PIGEON TRAP

The same trap as the Feral Pigeon Trap above but without the vinyl base.

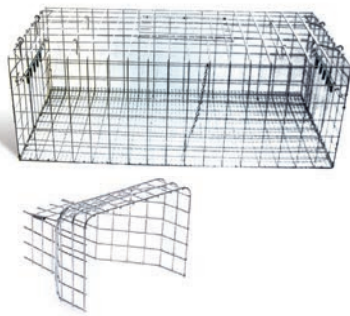

Each	ORDER CODE: BTRA050	£75.31
Ground Funnel	ORDER CODE: BTRA031	£22.94

SQUIRREL & MINK TRAP

Heavy-duty single catch trap. Once an animal steps on the treadle the drop bar holds the door firmly closed.

Dimensions: 600 mm x 175 mm x 150 mm

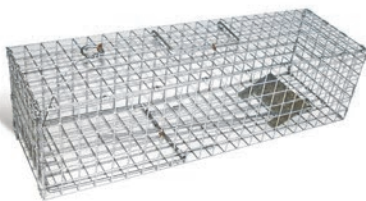

Each	ORDER CODE: BTRAL079	£24.20
------	----------------------	--------

FERAL CAT TRAP

Single catch treadle operated trap. Rear sliding door for removal. Trap also has a carrying handle.

Dimensions: 750 mm x 300 mm x 250 mm



Each	ORDER CODE: BTRAL027	£47.63
------	----------------------	--------

LIVE CAPTURE TRAPS

RABBIT METAL CAGE TRAP



Single catch trap. One door operated by treadle via a release arm.

Dimensions: 800 mm x 200 mm x 225 mm

Each

ORDER CODE: BTRAL006

£32.54

MC MOUSE MASTER TRAP



A double-entry multi-catch mouse trap. Steel trap design with galvanised finish with the capability to catch up to 30 mice.

Dimensions: 165 mm x 265 mm x 65 mm 0.52 Kg

Each

ORDER CODE: BTRAL010

£13.07

DOG/FOX TRAP

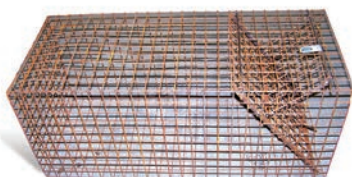

An extremely strong single live catch cage trap with bait hook release and deadfall galvanised door. The cage is constructed from heavy-duty square galvanised weldmesh and can be folded flat.

Dimensions: 1200 mm x 500 mm x 550 mm

Rigid versions are available on request, additional carriage and lead times apply.

Each

ORDER CODE: BTRDGFLA

£153.64

RAT & SQUIRREL TRAP

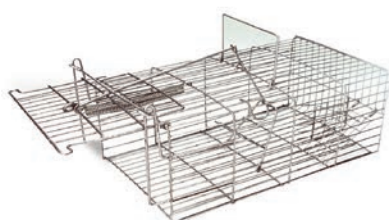

Very effective, single entry, spring door trap. Will catch adult and young rats and squirrels.

Each

ORDER CODE: BTRAL023

£14.51

ALBI 025 RAT TRAP

Compact, single entry, spring door trap. Can be secured to beams.



Each	ORDER CODE: BTRAL025	£12.65
------	----------------------	--------

MONARCH TYPE MULTI-CATCH RAT TRAP

This multi-catch rat trap has a one-way entrance and self-resetting door into the retention area. This tried and tested design is made from 15 swg welded zinc plated mesh.

Dimensions: 430 mm x 240 mm x 180 mm



Each	ORDER CODE: BTRAL022	£18.50
------	----------------------	--------

DOUBLE ENTRY SQUIRREL/MINK TRAP

Similar trap to the Standard Squirrel and Mink trap but slightly longer and with a door at both ends. The target species can see a clear exit the other end and therefore enters the trap more readily.

Dimensions: 160 mm x 150 mm x 710 mm

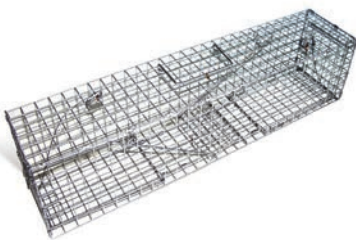

Each	ORDER CODE: BTRAL009	£43.59
------	----------------------	--------

FOLD-FLAT LARSEN CAGE TRAP

A flat-pack trap that pops up in seconds to trap magpies, rooks and jays. Single side-entry door with breakable perch for easy setting. Transportation handle, decoy sunshade, food and water drinker as standard.

Dimensions: 950 mm x 480 mm x 430 mm



Each	ORDER CODE: BTREC079	£85.96
------	----------------------	--------

BAIT SAFE LITTER BINS

PLASTIC BAIT SAFE LITTER BIN



The bins are dual function in that they can be used to collect litter and provide a secure enclosure for a bait station. The discarded litter/takeaway foodstuffs act as an attraction to rodents, and the enclosure provides safe and friendly harbourage. The bin can be used in any location, and because the bait stations are not in view, it is discreet and does not draw attention to the issue of vermin that are being dealt with.

In a recent trial, double Protecta LP bait stations were emptied by rodents in two days. Previously, bait boxes in the same location but placed in the open took ten to fourteen days to be emptied. As well as using high-quality tamper-resistant Protecta LP bait stations, the outer sleeve of the bin is also locked in place providing, excellent security.

Other options available including:
Different coloured sleeves; Replacement plastic sleeve; Spare Keys; Ash Tray and Cross foot and rooted frames for setting in concrete - POA.

Additional carriage charge applies for all bins - POA.
Please allow up to 21 working days for delivery.



Prices start from:

Each - 90 Litre	ORDER CODE: BBASABIN	£271.71
Each - 120 Litre	ORDER CODE: BBASA120	£335.73

METAL BAIT SAFE LITTER BIN



The bins are dual function in that they can be used to collect litter and provide a secure enclosure for a bait station. The discarded litter/takeaway foodstuffs act as an attraction to rodents, and the enclosure provides safe and friendly harbourage. The bin can be used in any location, and because the bait stations are not in view, it is discreet and does not draw attention to the issue of vermin that are being dealt with.

In a recent trial double Protecta LP bait stations were emptied by rodents in two days. Previously, bait boxes in the same location but placed in the open took ten to fourteen days to be emptied. As well as using high-quality tamper-resistant Protecta LP bait stations, the outer sleeve of the bin is also locked in place providing excellent security.

Other options available including:
Different coloured sleeves; Replacement plastic sleeve; Spare Keys; Ash Tray and Cross foot and rooted frames for setting in concrete - POA.

Additional carriage charge applies for all bins - POA.
Please allow up to 21 working days for delivery.



Prices start from:

Each - Slim Line	ORDER CODE: BMETABIN	£468.46
Each - 120 Litre	ORDER CODE: BMETA120	£484.08

ROMAX® RODENT SEAL



Romax® Rodent Seal uses a top-quality industrial sealant in a patented mix of stainless steel fibres. The benefits of such 'wire wool' plus proofing materials have long been known, but they've been combined to offer a professional and time-saving solution to exclusion for the first time. In addition, the product has been commercially tested and is 'metal-detectable', making it a good choice for sealing around plant and machinery in the food industry, whether this be for rodents, insects or just housekeeping.

Standard outer 25



1 x 310 ml

ORDER CODE: BRORODSE

£10.41

RODENT SEAL ADJUSTABLE NOZZLE



Adjustable nozzle that can be rotated in numerous angles for ease of application. Can also be used with other caulkable rodenticides such as Romax DP and Romax Venom Lipogel.

1 x 5

ORDER CODE: BRORONoz

£5.97

SODAL SILIRUB® 2 SEALANT



High-quality neutral silicone sealant that is UV resistant with very good adhesion on a variety of materials.

1 x 300 ml

ORDER CODE: BADHSIL2

£3.50

SODAL FIX ALL® TURBO



A high-quality adhesive-sealant based on SMX-Polymer. Good adhesion to most common materials, even on slightly damp surfaces. Weather and UV resistant.

1 x 290 ml

ORDER CODE: BADHFTUR

£6.25

EXPANDING FOAM



Polyurethane Expanding Foam (for use with foam gun). Also option for hand application without a gun.

For use with foam gun.

1 x 750 ml	ORDER CODE: BEXP700	£8.47
------------	---------------------	-------

Applied by hand.

1 x 750 ml	ORDER CODE: BEXP750	£7.98
------------	---------------------	-------

SOLVENT CLEANER



Solvent is used to flush and clean the gun applicator or dissolve 'stray' foam during proofing.

1 x 500 ml	ORDER CODE: BEXPFSOL	£8.78
------------	----------------------	-------

FIRE RATED EXPANDING FOAM



Fire-rated expanding Polyurethane Foam has been tested in horizontal and vertical applications to BS476 Part 20. Suitable for sealing joints where fire integrity and insulation is required e.g. walls, floors and partitioning. Perimeter joints around door and window frames and service penetrations.

For use with foam gun.

1 x 750 ml	ORDER CODE: BEXPFRGU	£10.73
------------	----------------------	--------

Applied by hand.

1 x 750 ml	ORDER CODE: BEXPFRHA	£10.73
------------	----------------------	--------

EXPANDING FOAM GUN



Expanding foam gun - Ideal for larger proofing works, an economical and professional method of applying expandable foam. Works with replaceable foam canister and cleaner. This system allows operators to apply foam accurately and cleanly!

Each	ORDER CODE: BEXPFGUN	£31.35
------	----------------------	--------

RODENT MESH GRILLS - STAINLESS STEEL



Similar to the mesh grills with stainless steel surround for greater proofing especially, for rats which tend to gnaw plastic.

Small (9"x 4")	ORDER CODE: BSSMGSML	£15.20
Medium (9"x 7")	ORDER CODE: BSSMGMED	£21.65
Large (9"x 9")	ORDER CODE: BSSMGLRG	£24.33

MOUSE MESH GRILLS



Easy to install this professional and sleek design is a great preventative measure to stop a wide range of pests from entering buildings. With it's weather resistant ABS frame and stainless steel mesh-mouse mesh grills can stop mice and wasps from entering building structures via air bricks.



Small (9"x 4")		
White	ORDER CODE: BMOBMSHS	£8.75
Brown	ORDER CODE: BMOBMBRS	£8.75
Black	ORDER CODE: BMOBBLKS	£8.75

Medium (9"x 7")		
White	ORDER CODE: BMOBMSHM	£10.05
Brown	ORDER CODE: BMOBMBRM	£10.05
Black	ORDER CODE: BMOBBLKM	£10.05

Large (9"x 9")		
White	ORDER CODE: BMOBMSHL	£11.88
Brown	ORDER CODE: BMOBMBRL	£11.88
Black	ORDER CODE: BMOBBLKL	£11.88

WELD MESH

Galvanised weld mesh is a self-colour weld mesh that has been coated in a liquid galvanise. Generally used for external projects or areas of moisture and available in different sized mesh, as well as lengths and widths.

Please contact the sales office for a quote based on your requirements.



6.5 mm Mesh		
6 m x 0.9 m	ORDER CODE: BBMIS077	£50.02
30 m x 0.9 m	ORDER CODE: BBMIS093	£176.07

25 mm Mesh		
6 m x 0.9 m	ORDER CODE: BMIS075	£33.13
30 m x 0.9 m	ORDER CODE: BMIS072	£170.62

XCLUDER



XCLUDER is made from stainless steel and UV resistant poly fibres and is ideal for proofing against rodents. The mesh is tightly woven, preventing rodents from getting through any gaps. The product does not rust or decompose. Supplied in a convenient dispensing box.

10 ft roll	ORDER CODE: BXCLUD10	£26.15
------------	----------------------	--------

WIRE WOOL

Ideal for restricting access to mice around small holes and gaps such as around pipes.



1 x 450 g	ORDER CODE: BWIRWOOL	£5.50
-----------	----------------------	-------

STANDARD FLY MESH ROLL

A 1.2 m wide x 30.5 m long fly mesh. Make up your own fly screens.

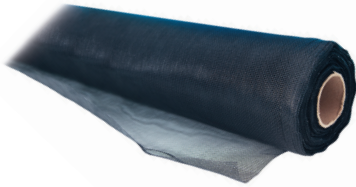

Per roll

ORDER CODE: BSTDFLME

£81.96

BRUSH STRIPS

Brush strip gives excellent protection against rat and mouse entry as well as a barrier to certain insects. Our brushes are made of high-quality nylon and are available as standard 1 m (997 mm) lengths. The smallest standard size is a 22 mm brush, up to the largest, which is 150 mm brush. Larger or smaller brushes can be made to order. Use the chart below to select the right brush required.

Aluminium carriers ensures strength and durability.

Filaments looped around a core wire, securely encased within a formed channel.

A range of filaments tailored to suit individual applications.

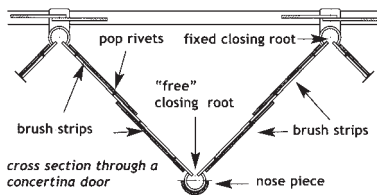
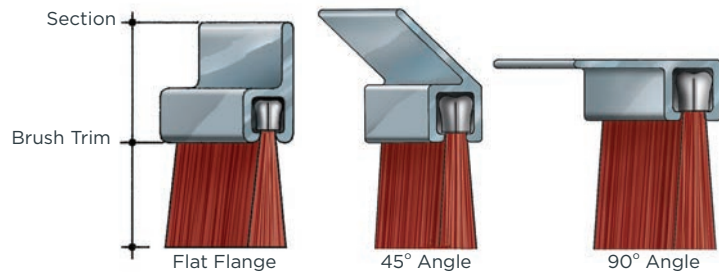

cross section through a concertina door

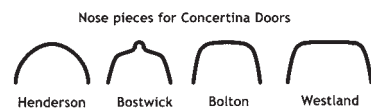

Concertina door kits. When ordering please specify:
 (a) Make of door.
 (b) The width of each panel (9" or 12").
 (c) The number of panels per door.

ORDER CODE: BCONDKIT
£9.79

Chain link curtain products are available upon request. Contact the Sales office to obtain a quote.

ORDER CODE	SECTION CODE	LENGTH	BRUSH TRIM OUT	CARRIER ANGLE	FILLING MATERIAL	PRICE (per 1m)
BB10362	B	1 m	22 mm	180°	BLACK NYLON 0.15 mm	£4.06
BB10363	B	1 m	22 mm	45°	BLACK NYLON 0.15 mm	£4.06
BB10364	B	1 m	22 mm	90°	BLACK NYLON 0.15 mm	£4.06
BC10118	C	1 m	35 mm	180°	BLACK NYLON 0.15 mm	£5.86
BC10120	C	1 m	35 mm	45°	BLACK NYLON 0.15 mm	£5.86
BC10119	C	1 m	35 mm	90°	BLACK NYLON 0.15 mm	£5.86
BD10194	D	1 m	43 mm	180°	BLACK NYLON 0.4 mm	£8.59
BD10196	D	1 m	43 mm	45°	BLACK NYLON 0.4 mm	£8.59
BD10197	D	1 m	43 mm	90°	BLACK NYLON 0.4 mm	£8.59
BE10093	E	1 m	75 mm	180°	BLACK NYLON 0.4 mm	£14.76
BE10092	E	1 m	75 mm	45°	BLACK NYLON 0.4 mm	£14.76
BE10091	E	1 m	75 mm	90°	BLACK NYLON 0.4 mm	£14.76
BG10210	G	1 m	102 mm	180°	BLACK NYLON 0.5 mm	£32.01
BG10209	G	1 m	102 mm	45°	BLACK NYLON 0.5 mm	£32.01
BG10211	G	1 m	102 mm	90°	BLACK NYLON 0.5 mm	£32.01
BG10212	G	1 m	150 mm	180°	BLACK NYLON 0.6 mm	£40.52
BG10213	G	1 m	150 mm	45°	BLACK NYLON 0.6 mm	£40.52
BG10214	G	1 m	150 mm	90°	BLACK NYLON 0.6 mm	£40.52

RAXIT READY TO USE



Raxit's patented seal is developed in the flexible and durable material Santoprene™. The 3,2 mm wide Santoprene™ is reinforced with embedded acid-resistant steel wires, which making it impossible for rodents and other pests to penetrate through it. The seal is corrugated to ensure the inlaid steel wires do not slide. The aluminium strip is produced in anodized aluminium (6063).

1 m - 20 mm	ORDER CODE: BRRTU20M	£18.83
1 m - 30 mm	ORDER CODE: BRRTU30M	£19.35
1 m - 40 mm	ORDER CODE: BRRTU40M	£20.81

RAXIT DOOR SEAL



The patented seal is developed in the flexible and durable material Santoprene™. The 3.2 mm thick Santoprene™ is reinforced with embedded acid-resistant steel wires, which makes it impossible for rodents and other pests to penetrate through it. Available in 1 metre replacement strips.

1 x 1 m	ORDER CODE: BRAXSEAL	£15.13
---------	----------------------	--------

ROMAX® RODENT MESH

Romax® Rodent Mesh is designed to provide a proofing solution to prevent gnawing and burrowing pests from entering homes, offices or buildings in a safe and environmentally responsible way. Made from stainless steel in a unique tube format that can be cut with scissors whilst remaining to be weather resistant with the ability to fold, roll and cut to size, then stapled and glued into position. Romax® Rodent Mesh is an essential part of the professionals proofing kit.



50 mm / 5 m	ORDER CODE: BMESH50-5	£8.93
50 mm / 20 m	ORDER CODE: BMESH50-20	£35.06
150 mm / 5 m	ORDER CODE: BMES150-5	£22.58
150 mm / 10 m	ORDER CODE: BMES150-10	£47.55

NEW **RAT TAPE**



A seriously tough rat and mouse proofing tape, two layers of butyl tape sandwich a dense stainless steel mesh core. It is incredibly flexible, virtually impenetrable and has excellent adhesion to most building materials and may be overpainted to blend with its surroundings.

The tape is 50mm wide and is used to cover holes and cracks in all building substrates. For larger defects, it can be lapped.

1 x 1 m	ORDER CODE: BRATAPE1	£8.00
1 x 5 m	ORDER CODE: BRATAPE5	£33.00

BUMPERSEAL

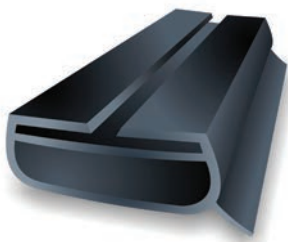

Bumper seal easily fits the bottom of shutter doors without the need for tools and is excellent for keeping draughts, water & vermin out even when the floor is uneven.

1 x 10 m	ORDER CODE: BBUMPSEA	£107.75
----------	----------------------	---------

XCLUDER DOOR SWEEPS



Rodent-proof controlled entry ways for commercial and residential applications featuring the patented Xcluder fabric. Available in a large commercial size, 50.8 mm (height) and a low profile solution, 12.7 mm (height). Both include mounting hardware and clips.

Heavy Duty	ORDER CODE: BHDSWEEP	£69.14
Low Profile	ORDER CODE: BLPSWEEP	£35.53

Mint Members enjoy
UP TO
20% OFF
PLUS PROMOTIONAL SAVINGS

RODENT GLUE BOARDS

ROMAX® RAT & MOUSE GLUE BOARD



Barrettine has long campaigned that glue boards should be available to professional users only, and to encourage responsible use of these valuable last resort tools, we have launched a new 'professional only' Romax® glue board - As well as a modern design, the product has the added benefit of the code of conduct and guidelines printed inside- along with their professional only recommendation. For efficacy & humaneness, it's also made to the highest specification to minimise the risk of escape. Each board is wrapped individually.
Standard Boards (23 cm x 19 cm)
Large Boards (33 cm x 21 cm)

1 x 48 - Mouse

ORDER CODE: BRMXGBMO

£39.11

1 x 48 - Rat

ORDER CODE: BRMXGBOA

£61.30

RAT & MOUSE TRAPPER GLUE BOARD



Rat Trapper Glue Board
 Plastic Tray. Internal size 112 mm x 237 mm.

Mouse Trapper Glue Board
 Internal Measurements 70 mm x 108 mm.

Rat - 4 x 12

ORDER CODE: BGLURATP

£66.04

Mouse - 1 x 96
 'while stocks last'

ORDER CODE: BGLUMOUP

£76.62

GLUE BOARDS FOR TRAPPER MC

A powerful adhesive board that fits into the Trapper MC.



1 x 48

ORDER CODE: BTRPRMCB

£23.29

TRAPPER LTD GLUE TRAP

A trap designed to catch mice and insects. Consists of a powerful adhesive on fibreboard and covered with a special release paper. The LTD also fits into the Trapper 24/7.



1 x 72

ORDER CODE: BTRAPLTD

£41.33

TRAPPER MAX GLUE TRAPS



The Trapper Max offers 40 % more surface area than the Trapper LTD and can be used against mice or insects. The pre-baited glue has been vigorously tested to ensure maximum holding power. The trap can either be laid out flat or folded into a tunnel.

1 x 72

ORDER CODE: BTRAPMAX

£27.90

MoBe® MOAT



MoBe® Moat has been designed and successfully used by professional pest controllers in conjunction with some of the industries leading food manufacturers.

The MoBe® Moat consists of 18 metres of siliconised paper with adhesive applied to one surface and has been manufactured as an aid to trapping mice and insects around problem, high risk areas. In addition to physically trapping pests, the strip is wide enough to act as a barrier to help prevent mice or insects from crossing over. The paper comes with pre-printed hazard warning lines so to warn others of the tape as well as usage instructions. The tape can be cut to the desired length giving a great number of potential applications. If trapping/monitoring insect pests, additional lures can be added along the tape's length.

Primarily the MoBe® Moat has been designed as a 'quarantine' barrier working in two ways:

- To stop potential movement by pests into previously infestation-free areas/products
- To cordon off known infested areas or products to prevent the spread of an infestation.

Some of the many potential applications:

- 1) To quarantine contaminated pallets of product and prevent cross-contamination to other stock, e.g. peanuts, rice, pet food.
- 2) To act as a barrier to known clean products, e.g. post fumigation commodities or finished product awaiting dispatch.
- 3) Using tape to glue the underside, MoBe® Moat can be stuck to the inside of silos to prevent migration of grain pests.
- 4) Act as a single large overnight trap in sensitive infested areas, e.g. around the perimeter of commercial kitchens against cockroaches.

Please be aware the start of the roll contains no glue.
Standard outer 15

Please note that whilst the glue has been designed and tested successfully against both mice and insects, as with other similar devices, we cannot guarantee that it will successfully retain all pests under all environments and conditions. When using primarily against mice, it should be seen as an aid to protecting goods rather than the only method of control or monitoring. Always use in accordance with the Pest Management Alliance Glue Boards guidelines. The MoBe® Moat is sold as a professional only product.



1 x 18 m

ORDER CODE: BMOBMOAT

£28.83

ROMAX® GLUE SOLVENT



A responsible and essential component of a Pest Technicians toolbox, the Romax® Glue Solvent solubilises the non-drying glue. This is ideal for removing insects from the Romax® Glue Boards for identification and cleaning hands or surfaces covered in glue. It is also key in the responsible use of glue boards and traps to release non-target pests quickly.

1 x 50 ml

ORDER CODE: BMOBGLUS

£7.76

RODENT GLUE BOARDS

RODENT control

PRODUCTS

RODENT CONTROL - RODENT GLUE BOARDS

PRIEST BAT



An essential part of the Professional Pest Control toolkit - A humane despatch method is a legal requirement to despatch rodents and necessary when live traps or glue boards are used and where an alternative to a rifle is needed. 25 cm long.

Each

ORDER CODE: BPRIESTB

£18.76

WEILS CARD



Working in close proximity to rodents increases the risk of coming into contact with *Leptospira* bacteria, a potentially lethal bacterial infection that causes Leptospirosis or Weil's disease. Carry this robust Weil's disease card in your wallet to inform and enable a Medical Practitioner to either eliminate this disease from the presented symptoms or initiate treatment.

Each

ORDER CODE: BWEILSCR

£POA



Product listing, page 107.

PEST MANAGEMENT ALLIANCE HUMANE USE OF RODENT GLUE BOARDS

Pest Management Alliance - Code of Best Practice - Humane Use of Rodent Glue Boards

In order to protect public health within high-risk environments, the use of rodent glue boards remains an important last option when all other control methods have been considered ineffective. Although glue boards are not designed to physically harm rodents, their use raises valid concerns and they should only be sold to or used by technicians who have been given adequate training and are competent in the effective and humane use of this technique. The following principles must be followed in order to minimise animal welfare concerns:

1. Option of last resort

All other options for rodent control must be considered before glue boards are used. Detailed records must show why other control methods are either considered inappropriate or have failed. Where there is a rodent in a high-risk environment, it may be appropriate for glue boards to be placed strategically to ensure immediate control.

2. Check boards frequently

Where rodent boards are used, these must be inspected at appropriate intervals. This should be within 12 hours of placing, or at least as soon as is reasonably practicable, including weekends and bank holidays. If unavoidable events cause slight extensions to inspection intervals, then the reasons should be recorded. Longer delays must be avoided (see contingency plan below).

Where possible and practical, inspection times must be organised to minimise the time rodents are likely to be on the board (e.g. if rodents are known to be active during certain periods, inspection times should be arranged with this in mind). If a caught animal displays signs of undue suffering or serious physical harm, the intervals between inspection times must be shortened. Records must be updated after all inspections.

3. Contingency plan

A contingency plan must be in place so that in the event of an emergency, a second competent person can be called upon to inspect the boards and deal with any captures or safely remove the boards as appropriate. Where it is known boards will not be inspected at appropriate intervals, they must be taken up (even if only temporarily).

4. Protect non-target species

Boards must be placed in such a manner that they do not present a risk to non-target species.

5. Use the correct size board for the pest species

The size of board must be appropriate for the target species.

6. Detailed records

Detailed copies of records and location plans should be available on-site at all times for all boards laid during any treatment and must be updated as necessary to ensure traceability. Copies ensure information is available should site records be lost or unavailable.

7. Dispatch of trapped rodents humanely

Rodents trapped on rodent boards must be dispatched quickly and humanely by technicians with appropriate training. Placing the glue board in a clear plastic bag and dealing the rodent a sharp blow to the head with a blunt instrument would be an appropriate mode of dispatch. Drowning is not an acceptable method of dispatch.

8. Non-target animals

In the event that a non-target animal is trapped, a suitable food-grade oil or similar emollient should be applied to the animal for removal, or if not a protected species, it may be killed humanely. Non-targets should only be released at their site of capture, not elsewhere, and only if they appear to be physically unharmed and their release is not prohibited by law.

9. Remove boards at the end of treatment

At the end of treatment, all rodent boards must be accounted for, removed by the technician, and the records endorsed accordingly.

10. Dispose of boards safely

Rodent boards should be disposed of with care. The sticky surface should be covered to avoid the accidental trapping of non-target species or subsequent misuse, and the board should be disposed of in accordance with local authority waste requirements.

11. Communication with the customer

This Code of Best Practice must be provided to the customer to make them aware of the standards that the operative is working to.

The humane use of glue boards is the legal responsibility of the pest controller and cannot be delegated to untrained people. All technicians must be suitably trained and competent in their application, maintenance and ultimate disposal, including the dispatch of the target species and safe removal of non-target species.

This Code of Best Practice was produced after consultation with Defra and Natural England. Updated February 2017. For additional copies of this code, please call the sales office.

FUMIGANTS & ACCESSORIES

For the control of Rabbits, Moles and Rats.

RODENT control

PRODUCTS

RABBITS (*Oryctolagus coniculus*)



The most effective time for treatment for control of rabbits is from around November to March when the rabbit population is at its lowest, and the burrows are most accessible. Before treatment, ensure that rabbits lying out in the surrounding area are driven to ground.

Treatment

- 1: With the loaded Phostoxin Applicator, insert one pellet as far into each hole as practicable, usually 30cm (12") is adequate.
- 2: As soon as the pellets have been deposited in the hole, seal the hole with turf, grass side down.
- 3: If fresh rabbit activity is noticed after a few days, repeat the treatment until no further activity is visible.
- 4: Please be aware of the new label changes. Burrows, runs and harbourages can not be treated if they are less than 25 m from any building occupied by man or animals.

MOLES (*Talpa europaea*)



Moles are generally found from sea level to 3,000 ft in many soil types and live almost entirely underground in tunnel systems which consist of main and subsidiary tunnels, whose main purpose is to trap earthworms for food.

Tunnelling is carried out from the nest, which is its sleeping and breeding quarters. Breeding in March and May is the only time moles meet, otherwise, they are solitary animals. Molehills are a problem in lawns, sports grounds and pasture, causing considerable damage to soil and machinery. The mole, who consumes vast quantities of earthworms, can also cause serious disturbance to crop root systems.

Moles are solitary animals and very territorially protective of their area. This can be very misleading when confronted with an area with many molehills, but as a rule, even heavy infestations can mean only eight moles per hectare (three per acre) even in good feeding areas with a high population of earthworms, their primary food.

(Above text courtesy of Rentokil Ltd.)

PHOSTOXIN SPHERICAL TABLETS



Phostoxin is supplied in packs of 30 x 3g tablets, each containing 57% Aluminium Phosphide for the control of rats, rabbits and moles. Please note that all users must hold a current and recognised certificate in the safe use of metallic phosphides. To purchase Aluminium Phosphide, you must hold a level 2 Safe Use of Aluminium Phosphide qualification. The certified person must also be at the delivery address to receive the product.

30 x 3g

ORDER CODE: BPHOS.09

£33.09

TALUNEX SPHERICAL TABLETS



Contains 56% Aluminium Phosphide.
Each flask contains 160 x 0.6 g aluminium phosphide tablets.

Animal burrows, runs and harbourages cannot be treated if they are less than 10 metres from any building occupied by man or animals. The previous label regarding the distance from occupied buildings referenced three metres. Please contact the sales office for the latest product information as legislation regarding this product is regularly amended/ updated.

Each

ORDER CODE: BLUTA.10

£29.37

PHOSTOXIN APPLICATOR



For use with Phostoxin. Flasks now screw directly on to applicator.

Phostoxin Applicator

Each

ORDER CODE: BPHOSAPL

£99.95

Phostoxin Applicator Spare Tube

Each

ORDER CODE: BPHOAPTU

£14.05

PHOSTOXIN APPLICATOR CARRY CASE



A professional and convenient way to transport and store your Phostoxin applicator. Handy side pouch also allows transportation of Phostoxin flask (not intended for flask storage).

Each

ORDER CODE: BPHOSBAG

£26.50

PHOSTOXIN DIBBER



Quality tool to find mole runs & make holes.

Each

ORDER CODE: BPHOSDIB

£17.36

TOPEX APPLICATOR KIT & SPARES



System avoids any operator handling of Talunex, so is a preferred applying method under COSHH. Comes with a carrying case and metal probe.

Applicator

ORDER CODE: BLUTOPAP

£143.66

Trigger Assembly

ORDER CODE: BLUTRIGG

£60.90

Barrel

ORDER CODE: BLUBARRL

£48.10

Black Lid

ORDER CODE: BLUBALID

£32.79

POLYTHENE SHEETING



Polythene sheeting (38 micron) for encasing product before fumigation. Minimum order and additional carriage charges may apply. Please call the sales office for details.

13 m x 50 m

ORDER CODE: BPOLYSH5

£POA

13 m x 100 m

ORDER CODE: BPOLYSHE

£POA

UNIPHOS PHOSPHINE DETECTOR STRIP

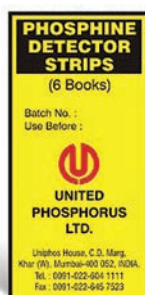

Simple and cost effective method of phosphine detection.
A very useful way to help ensure a safe working environment.

6 x 20 Strips

ORDER CODE: BUNIPHDS

£POA

DEGESCH FUMIGATION PLATES



Degesch Plates are intended for use in fumigating packaged or bagged goods and processed commodities, including tobacco in cases, bales or hogsheads. Fumigation may be carried out under gas-impermeable sheeting or in shipping containers, when goods are required to be fumigated in transit. Each Degesch Plate is sealed in a gas-impermeable foil sachet. For use only by certificated fumigation contractors.

Drum 120 x 117 g Plates
Carriage charge may be added.

1 x 120

ORDER CODE: BPHOSPLT

£1063.33

UNIPHOS AIR SAMPLING PUMP & PHOSPHINE DETECTOR TUBE

An ideal way of spot checking phosphine concentrations around and inside a fumigated area. Detection is possible at concentrations as low as 0.1 ppm up to 3000 ppm.



Each

ORDER CODE: BUNIPUTU

£POA

UNIPHOS DOSIMETER TUBES



A unique method to determine total phosphine dose during fumigation to ascertain and provide proof of treatment adequacy.

1 x 10 Tubes

ORDER CODE: BUNIDOST

£POA

DRÄGER PAC 8000



The single-gas detector for personal air monitoring is used for reliable alerting of the presence of phosphine gas.

- Triple alarm: optical 360° alarm LEDs, acoustic (90 dBA) and vibration with an event and data logger
- Gas inlets on the top and on the front with an impact-resistant housing
- Detection limit: 0.02 ppm with a measuring range between 0 to 20 ppm with a resolution of 0.01 ppm
- Dimensions of 60 x 84 x 20 mm and weight of 113 g and Includes Lithium batteries that can be replaced when discharged.

Each

ORDER CODE: BPAC8000

£577.39

SCOOT REPELLENT



Contains 88 % (w/w) Aluminium Ammonium Sulphate. Widely acclaimed as the most effective fox repellent on the market, Scoot is a patented non-toxic formula used to keep foxes away from protected areas. Scoot can be used in gardens, on plants and edible crops and is humane, biodegradable and very effective.

2 x 50 g

ORDER CODE: BSCO100G

£11.76

We've made it
SUPER EASY

TO ORDER ONLINE

BarrettineEnv.co.uk



RAT BLOCKER



Our stainless steel rat drain blocker fits snugly into wastewater or sewage pipes, acting as a one-way valve. Simply put, waste water can flow out, but rodents are prevented from accessing the property by moving in the opposite direction. Forms an effective barrier for rodent incursions into a property, stopping the problem before it starts.

RATBLOCKER

Each - 4 inch

ORDER CODE: BRATBLOC

£109.23

EXTENDABLE MOUNTING POLE

Each
(100 cm - 200 cm)

ORDER CODE: BRATPOLE

£62.45

RATWALL



Ratwall is a robust, well-engineered, highly effective stainless steel rodent exclusion unit for installation within a drainage / pipe system. External Hinge & Pipe Stop. 100% Stainless Steel. Compressible Side Walls.

Ratwall - 110mm

ORDER CODE: BRATWAL

£83.18

Ratwall - 150mm

ORDER CODE: BRAT150

£122.63

RATWALL INSTALLATION POLE

Each

ORDER CODE: BRAT151

£23.42

NORDISK RAT BLOCKER



Stainless Steel Nordisk TX11 twin flap Rat Blocker, 100mm (4 inches) diameter and 150mm (6 inches) are industrial grade, suitable for clay, PVC & cast iron pipe systems to suit installation within either an outlet or inlet of a drainage chamber. Other sizes are available.

Each
(100 mm/110 mm)

ORDER CODE: BNORD004

£215.49

Each
(150 mm/160 mm)

ORDER CODE: BNORD006

£259.22

NORDISK TX11 INSTALLATION POLE



1 metre Stainless Steel Nordisk TX11 installation pole for ground level installation of the TX11 units.

Each

ORDER CODE: BVERMP1M

£33.84

METEX
Innovation for Construction®

No 1 in the UK for Rat Blockers

- Un-rivalled range
- Unbeatable quality
- Easiest to install



Ratwall is great value.
Robust, with easy fitment
(installation poles up to 2m)
and cannot become lost
into the drain.

RATWALL
BY **METEX**

NORDISK INNOVATION

The Dogs Dangles!
The Nordisk TX11
with sizes up to Ø350mm and
100,000+ installations

Ratwall.co.uk for technical information, videos, testimonials and more

UNIKEY

Simply swap tips to
openlift most
manholes.

BY **METEX**



METEX UNIKEY



The kit includes two handles and a range of interchangeable tips, stored in a useful roll pouch including 33mm T tips, 22mm T tips, 10mm Hook tips, M10 Screw tips, M12 Screw tips, M16 Adaptors and a Stopcock Key.

Unikey handles and tips have a 250kg Safe Working Load certified by Lloyds British Testing (1000 Kg straight-pull destructive testing). Stopcock tip not tested. Unikey is manufactured from quality Zinc plated carbon steel.

Each

ORDER CODE: BMUNIKEY

£42.16

WATERTIGHT NON RETURN VALVE



Simple to install the watertight 110 mm non-return valve can help prevent backflow flooding due to floods or sewer blockages. Rats are prevented from entering the property via the drains. Noxious fumes from the sewer system are also unable to escape.

Each
(Stainless Door)

ORDER CODE: BNRVS110

£92.83

Each - Clay

ORDER CODE: BNRVCL11

£89.67

Each - Plastic

ORDER CODE: BNRVP110

£89.67

DRAIN LIFTING KEY



Made from a single piece of malleable iron with a tee handle.

Pair

ORDER CODE: BDRAINKEY

£11.17

ROMAX® DRAIN TRACING DYE



Non-toxic organic dyes and, where possible, are made from food-grade or similar concentrates.

1 x 200 g
Blue

ORDER CODE: BTRDYEBL

1 x 200 g
Green

ORDER CODE: BTRDYEGR

1 x 200 g
Red

ORDER CODE: BTRDYERE

1 x 200 g
Orange

ORDER CODE: BTRDYEOR

1 x 200 g
Yellow

ORDER CODE: BTRDYEYE

10 x 20 g
Orange Sachet

ORDER CODE: BTRDORSA

£10.60

£14.70

PARVO KILL



Passes virucidal effectiveness test against canine parvovirus at a dilution of 1-35 in water. Parvo-Kill has been formulated to be a true dual-purpose product for cleaning and disinfecting high-risk areas. It can also be used for general cleaning and disinfecting of hard surfaces e.g. sinks, worktops & pre/post animal housing at a rate of 1-100 in water.

1 x 5 Litre
‘While stocks last’

ORDER CODE: BPARV005

£23.35

SORGENE XTRA



Sorgene Xtra is a broad spectrum disinfectant highly effective in farm conditions against bacteria, viruses and fungal spores. Sorgene Xtra has DEFRA approval for 3 notifiable diseases (foot-and-mouth, poultry orders and general orders) and lower dilution rates, compared to Sorgene 5, on some diseases.

1 x 5 Litre

ORDER CODE: BSORG005

£54.58

ANTI-STATIC FLUID



A non-hazardous water-based formulation to combat static electricity caused by man-made carpets and textiles, otherwise known in the industry as “cable mite”. Dilute 1-9 with clean water. Suitable for use in shops, offices, computer rooms, general industry and at home.

1 x 5 Litre

ORDER CODE: BANTI005

£16.24

Save time, place your order any time.

PAY ONLINE

BarrettineEnv.co.uk



HYGIENE & DISINFECTANTS

75% ALCOHOL SURFACE CLEANER



Barretine 75% Alcohol Surface Cleaner has been formulated as an effective broad-spectrum ready to use solution against bacterial and fungal pathogens. Tested to BS EN 1276 and BS EN 13697 (effective against *E. coli*, *E. hirae*, *S. aureus* and *P. aeruginosa*).

- Product Benefits:**
- 75% Alcohol active ingredient
 - Ready-to-use formulation
 - Universal surface cleaner
 - Easy application

6 x 500 ml	ORDER CODE: BSURF500	£17.40
2 x 5 Litre	ORDER CODE: BSURF5LT	£35.16

ALCOHOL HAND SANITISER



Barretine Alcohol Hand Sanitiser is manufactured to World Health Organisation Formulation 2 standards and can be used as a versatile liquid hand rub. This product is manufactured under an official derogation from the HSE under the biocides directive.

- Product Benefits:**
- Made to official recognised WHO standards
 - Effective & ready to use hand sanitiser
 - Economical
 - Easy application

6 x 500 ml	ORDER CODE: BHAND500	£15.60
2 x 5 Litre	ORDER CODE: BHAND5LT	£29.00

BACTERICIDAL HAND SOAP



A high quality pearlescent bactericidal liquid hand soap. Fragrance-free for use in the food & catering industry. Provides a rich lather that is mild and gentle with a thorough cleaning & sanitising action - ideal for topping up soap pump dispensers.

1 x 5 Litre	ORDER CODE: BHACL005	£11.22
-------------	----------------------	--------

NILAQUA 'ALCOHOL FREE' HAND SANITIZER



Nilaqua is a fragrance & alcohol free advanced Hard Surface / Multi-Surface cleaner and Hand Sanitiser that is fast-acting and a powerful germ killer (99.9999%), effective within 30 seconds yet kind to the individual and environment, not stripping surfaces as it contains no irritants within its formulation.

1 x 500 ml	ORDER CODE: BNWRH005	£7.09
------------	----------------------	-------

WEPALM HAND SANITISER DISPENSER & REFILL POUCH



Use our cost effective top up system & save money and time! WePalm hand sanitiser comes in easy to store, easy refill pouches. Made with a synergistic blend of detergents to provide a mild but thorough cleaning and sanitising action. With its skin friendly sanitising, cleaning and moisturising action, it allows constant use in catering/kitchen areas, hospitals, nursing homes and can be mounted inside a pest control vehicle for ease of action & access. Once dispensed, produces a pre-lathered foam. The spread-ability of the foam increases the cleaning and disinfecting performance, getting to areas such as in-between the fingers where bacteria hide. Used in conjunction with our pump action dispenser that does not rely on battery operation to provide further cost savings. Complies to BS EN 13727, 13624, & 14476. BPR compliant.

Dispenser	ORDER CODE: BSOAPDIS	£12.31
Pouch 1 x 6	ORDER CODE: BHANDSOA	£23.08

DUOMAX DISINFECTANT & WIPES



DuoMax is a strong disinfectant with a cleaner that has excellent virucidal and antibacterial properties. DuoMax has successfully passed test BS EN 14476 (2005) - Chemical disinfectants and antiseptics, Virucidal quantitative suspension test for chemical disinfectants against CORONAVIRUS.

DuoMax has the following test data: EN 1276, EN 1650, EN 13704, EN 14476.

1 x 5 Litre	ORDER CODE: BDUOMAX5	£23.00
1 x 200 Wipes	ORDER CODE: BDUOW200	£7.95

GORILLA WIPES



No need for messy cloths or even water. Ideal multi-purpose cleaning wipes for hands, bait boxes and other surfaces. Not only removes a variety of substances, it also has anti-bacterial agents that effectively kills bacteria that transmits Weil's disease.

1 x 80 Wipes	ORDER CODE: BGORIINW	£8.78
--------------	----------------------	-------

LARGE PAPER ROLL



The essential material for all vans and stores, cleaning boxes and equipment, small spillages, cleaning and drying hands. So simple but so indispensable! Each roll is approximately 150 metres long.

Each	ORDER CODE: BBLUROLL	£3.06
------	----------------------	-------

CLEANING TOOLS & DISPOSABLE KITS

LITTER PICKER 102



Top-quality litter picker 102 cm long. Ideal for picking up sharps and needles plus anything else that you don't want to handle. Can also be used for retrieving and placing baits in awkward places.

Each	ORDER CODE: BLPICLP3	£17.36
------	----------------------	--------

LONG HANDLE SCRAPER



An excellent tool for scraping up all sorts of horrors such as bird muck, grease and grime etc. Comes complete with a replaceable 200 mm x 1.3 mm stainless steel blade and 1300 mm handle.

Each	ORDER CODE: BSCRMSC1	£21.13
Spare Blade	ORDER CODE: BSCSPBLA	£3.50

MINI-GRABBER



A mini 'grabber' designed to be easily carried in your pesticide bag, allowing you to professionally and hygienically remove items such as dead rodent bodies without having to come into contact with them. Approximately 30 cm long.

Each	ORDER CODE: BMINIGRB	£7.37
------	----------------------	-------

BROOM, SPADE, DUSTPAN & BRUSH



BROOM
A 24" Platform broom with natural Coco filled head. Supplied complete with 48" stayed handle.

SPADE
A metal square open mouth Bulldog shovel.

DUSTPAN & BRUSH - Plastic

Broom	ORDER CODE: BAWBROOM	£9.78
Spade	ORDER CODE: BAMSPADE	£42.91
Dustpan & Brush	ORDER CODE: BADUSTPB	£2.48

HAND SCRAPER



Stainless steel 75 mm x 0.8 mm blade with plastic hand grip.

Each

ORDER CODE: BHASCRAP

£7.82

WIRE BRUSH WITH SCRAPER



Tough wire brush and metal scraper.

Each

ORDER CODE: BWBSCR26

£3.86

HEAVY DUTY PLASTIC SACKS



General purpose heavy-duty plastic sacks.
Dimensions: 610 mm x 1219 mm.

1 x 10

ORDER CODE: BPS18098

£6.07

1 x 200

ORDER CODE: BPS18BUL

£121.49

DISPOSABLE CARCASS BAGS & BAIT BAGS

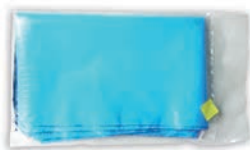

DISPOSABLE CARCASS BAGS
Rodent carcass disposable bags.

BAIT BAGS

A clear plastic bag to hold bait securely.
Each bag is printed with a warning that rodent bait is held inside.



DISPOSABLE CARCASS BAGS

1 x 10

ORDER CODE: BCARCUBA

£8.49

BAIT BAGS

1 x 1000

ORDER CODE: BBAITBAG

£18.36

DEODORISING PRODUCTS

RODENT control

PRODUCTS

RODENT CONTROL - DEODORISING PRODUCTS

PEST DEODORISING FLUID



A non-hazardous deodorising fluid specially formulated to counteract general offensive day to day odours such as dead rodents. It has a powerful long-lasting fragrance available in either cherry or peach. Ideal for use in public and domestic utilities, sewage treatment plants, refuse tips, refuse bins and drains etc. Fragrance may vary.

1 x 5 Litre (Cherry)	ORDER CODE: BPDFC005	£15.00
1 x 5 Litre (Peach)	ORDER CODE: BPDFP005	£15.00

POLVO DEODORANT



Polvo Deo is a highly absorbent powder and deodoriser in one. Polvo Deo is ideal to managing smells, bacteria, and liquids safely and effectively without the use for additional chemicals or scented sprays. The product works by absorbing bacteria and toxic fumes that will cause odours and insect attraction in decomposing organic waste.

Each	ORDER CODE: BPOLDE01	£9.29
------	----------------------	-------

DEODORISING BLOCKS



A powerful cherry-scented deodorising blocks ideal for leaving in voids to give off fragrance for up to four weeks, masking the smell of dead rodents and ideal sell on.

1 x 12	ORDER CODE: BPDBLXMI	£31.37
--------	----------------------	--------

Save time, place your order any time.

PAY ONLINE

BarretlineEnv.co.uk



USER FRIENDLY



EASY TO SIGN UP



LATEST PRODUCTS & PROMOTIONS



EMPTY TUBS

Useful container for decanting rodenticides or relocating spent bait.



3 Kg (5.7 Litre)

ORDER CODE: BMTTUB57

£4.04

10 Kg (16 Litre)

ORDER CODE: BMTTUB16

£4.42

CURTEC PESTICIDE STORAGE JARS

These jars also fit into our pesticide carry bags.



Each

ORDER CODE: BPESTJAR

£3.78

PLASTIC MEASURING SCOOPS & BAITING SPOON



PLASTIC MEASURING SCOOPS: This small green plastic scoop is ideal for use in decanting rodenticide etc. It is UK manufactured and is narrow and deep. There is a hole in the handle allowing the scoop to be hung up.

LARGE BAITING SPOON: A large baiting spoon allows you to accurately and securely place bait into burrows. 'Standard' length on the large spoon is 14"



0.5 Litre Scoop

ORDER CODE: BASCOSMA

£3.32

1.5 Litre Scoop

ORDER CODE: BASCOLRG

£8.64

Baiting Spoon

ORDER CODE: BBASPO16

£7.39

205 LITRE UN APPROVED DRUM

205 Litre UN approved clip top drum. Ideal for the safe storage of waste etc. Does not include trolley.



Each

ORDER CODE: BWADR205

£56.22

TREATMENT REPORT PADS



A two part A5/A4 NCR treatment report pads. Each pad consists of 75 reports.

Each - A5	ORDER CODE: BTREAPAD	£5.21
Each - A4	ORDER CODE: BTREAPA4	£7.97

ROMAX® MOUSE BOX DATE LABELS

Date sticker designed to fit inside the Romax® mouse box (and other brands). Allows up to 20 dates and allows the operator to tick which 'active' is in use in the box. Made from vinyl weather-resistant material.



1 x 100	ORDER CODE: BROINSMO	£9.95
---------	----------------------	-------

EXTERNAL BAIT BOX POINT LABELS

Vinyl weather-resistant bait point label. For use with any baiting point.



1 x 100	ORDER CODE: BROINSLA	£6.25
---------	----------------------	-------

PERSONALISED COLOUR LABELS

Vinyl weather-resistant personalised labels. Size: 102 mm x 51 mm. For use on bait boxes with a personalised logo.



1 x 100	ORDER CODE: BLABPERS	£6.25
---------	----------------------	-------

POISON DO NOT TOUCH LABELS

Vinyl weather-resistant Poison Warning label. For use with any baiting point.



1 x 100	ORDER CODE: BLABPOIS	£5.46
---------	----------------------	-------

BAIT BOX INFORMATION LABELS

Anticoagulant rodenticides refer to a requirement for labelling bait stations with specific information. To make life simpler for pest controllers, Barrettine has produced a new 'Box Information Label'. This label contains the required information and can be affixed to the outside of mouse and rat bait stations. The sticker is waterproof, resistant to UV-light and can be written on with a permanent marker pen or ballpoint pen.



1 x 100	ORDER CODE: BBOXLAB1	£6.25
---------	----------------------	-------

TECHNICIANS FIELD GUIDE

A complete and essential guide for the professional.

The Barrettine's pocket-size A6 Pest Technicians guide contains detailed information to assist in the daily routine of a Professional Pest Control Operator: A 'how to' guide covering topics of insect and rodent information and identification, equipment calibration, non-chemical insect control measures, pesticide application and product safety, dealing with waste: Triple rinsing as well as detailed information on LD₅₀.

PRICE: £23.03
ORDER CODE: BPIDBOOK



FLYING INSECTS

CRAWLING INSECTS

SPI, AGRICULTURE & AMENITY PESTS

RODENT PESTS

BIRD PESTS



BIRD REPELLENTS

BIRD NETS

NET FIXINGS

SPIKES

SPIKE FIXINGS

SURFACE PROTECTION

BIRD WIRE, POSTS & FIXINGS

AVISHOCK & ACCESSORIES

BIRD MESH & PROOFING

BIRD TRAPS

SCARING DEVICES

BIRD control

PRODUCTS 

PEST CONTROL CATALOGUE 2021

ORNAWAY® BIRD REPELLENT

Ornaway® Bird Gel is a novel, highly effective yet discrete bird deterrent for use on buildings and other structures.

The convenience of Ornaway in pre-filled dishes allows a significant time-saving aspect to the bird installation. The formulation combines initial olfactory repellents with high electromagnetic reflectance spectrums that birds avoid. To be used within an integrated approach to manage birds that could include housekeeping/ cleaning, trapping, spikes and netting. Once properly installed, the product remains effective for at least two years, even in harsh climates.

The gel is intended to be applied in the UV stabilised, low-profile dishes that are supplied with the product. Once installed, the dishes are usually invisible from ground level, so do not detract from buildings' visual appearance.

Ornaway® Bird Gel is also offered in pre-filled dishes as pictured below. The 300 g Caulking Tube includes 15 dishes for filling.



1 x 300 g Caulking Tube	ORDER CODE: BBIRORGE	£32.66
15 Pre-Filled Dishes	ORDER CODE: BORNDISH	£34.97

ORNAWAY® DISH MAGNETS

Ornaway® bird dish magnets offer the user ultimate versatility in the installation of Ornaway® bird gel. The heavy-duty magnets allow the dishes to be securely attached to metallic structures and will remain in place, even in windy conditions.



1 x 15	ORDER CODE: BBIRORMA	£16.16
--------	----------------------	--------

GUANAWAY & GUANAWAY RTU

BUY 3
RTU
GET 1
FREE
25% OFF



Disinfectant and cleaner. Contains Didecylidimethylammonium Chloride for use with the cleaning up of bird waste. Unlike other products, Guanaway is a powerful alkaline cleaner degreaser that neutralises the acidic by-product associated with bird droppings. This reduces the corrosion to the stonework and increases safety by removing the slippery, greasy waste. Also available as a handy RTU trigger spray version ideal for those small jobs when making up a full sprayer isn't justified. Ideal for disinfecting traffic lights, won't discolour plastic.

1 x 750 ml Ready to use	ORDER CODE: BGUANRTU	£8.75
6 x 750 ml Ready to use	ORDER CODE: BGURTUBP	£41.54
1 x 5 Litre Concentrate	ORDER CODE: BDISB005	£39.80

Barrettine
Environmental Health



Ornaway

Bird Gel

Visual & Olfactory
Bird Repellent

- ✓ Highly Effective Bird Repellent Gel
- ✓ Proven to be effective by the UK Pest Control Industry
- ✓ 2-5 Year Life Span

Available in: 15 x 15 g Pre-filled Dishes or 250 g Caulking Tube

Available with: Gutter Clips, Window Clips & Magnetic Dishes



Developed by UK scientists.
Manufactured in the UK.



Barrettine Environmental Health

Unit 4 Caxton Business Park, Crown Way, Warmley, Bristol BS30 8XJ.

Tel 0117 967 2222 Fax 0117 961 4122 Email beh@barrettine.co.uk www.barrettineEnv.co.uk

INSTALLING A NET UP TO 10 m BY 10 m

Before starting to install a net, it is always important to make sure that the design of the installation is optimum. You want the net to be effective at keeping birds off the building, whilst at the same time not looking obtrusive.

Nets should be installed in a way that minimises the risk of damage by the action of wind. You also want the net to be as straightforward to install as possible. Net installations will vary depending upon the bird species you are proofing against, the substrate you are attaching the net to, e.g. masonry, timber, steelwork or cladding/soft substrate, and the size of the net. Below is a step-by-step guide into effectively installing a pigeon net of size 10 m by 10 m or less.

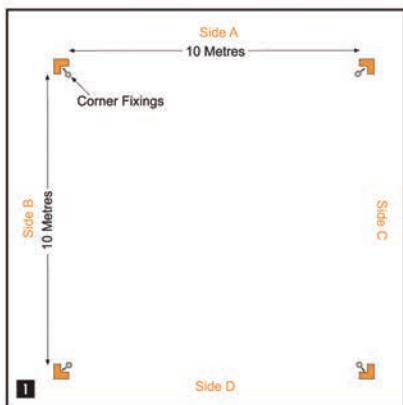

1 Drill holes and fit Corner Fixings where the net will turn a corner.

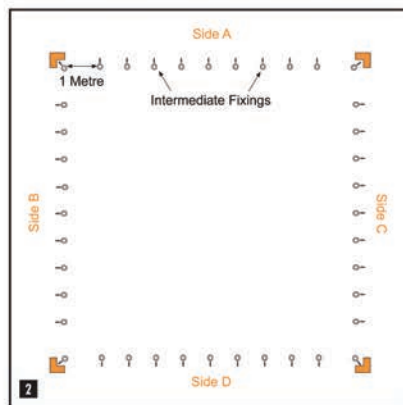

2 Drill holes and fit intermediate fixings at 1 m intervals in a straight line between the corner fixings.

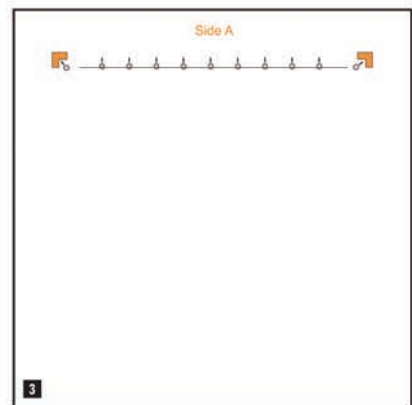

3 Run 10 m of wire rope through the fixings of one side.



4 Attach one end of the wire rope to a corner fixing using a loop of wire and secure with either 2 ferrules (each crimped twice) or 2 wire rope grips.



5 Hook an opened barrel strainer to other corner fixing and thread the free end of the wire through the eye of the barrel strainer, and pull the rope tight. Secure the looped wire using 2 ferrules (each crimped twice) or 2 wire rope grips.



6 Run 10 m of wire rope through the fixings of one side.

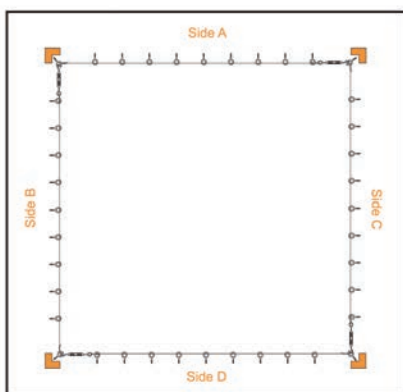

To install the net itself, attach one corner of the net to the corner fixing using the net corner tie.



Hogging every mesh to the wire rope ensuring that the net is pulled tight and is square. Attach the other 3 corners using net corner ties. Trim off any surplus net.

Repeat steps 3 to 6 for the other three sides.

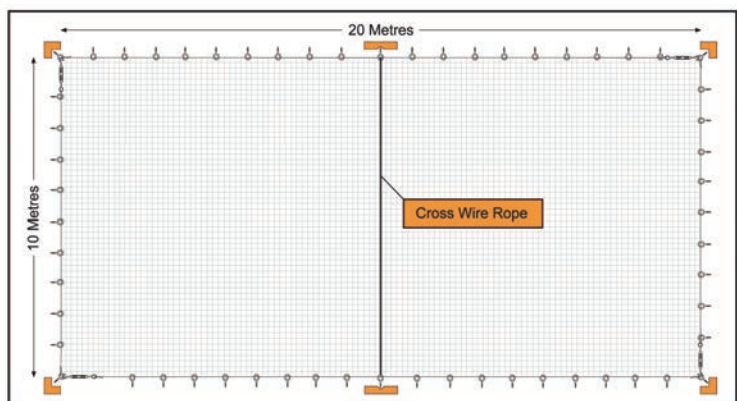

For nets larger than 10 m by 10 m
The only major differences for installing a larger net, is that you will need to install corner fixings every 10 m to spread the weight of the net. You may also need to install additional cross wires to prevent the net from sagging in the middle. e.g. 20 m x 10 m net.

Complex Net Installations
We recognise that some bird net installations are more complex than fixing a square net onto a flat surface. If you are uncomfortable about carrying out a complex installation, we recommend that you contact a professional and experienced bird management company.

SPARROW BIRD NETS

19 mm BLACK

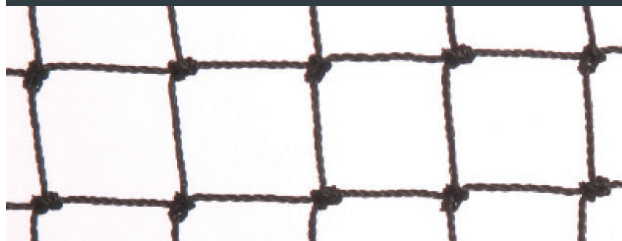

SIZE	ORDER CODE	PRICE
5 x 5 m	BNET19BA	£33.18
10 x 5 m	BNET19BC	£66.37
10 x 10 m	BNET19BB	£132.73
15 x 5 m	BNET19BF	£99.55
15 x 10 m	BNET19BD	£199.10
15 x 15 m	BNET19BE	£298.64
20 x 5 m	BNET19BJ	£132.73
20 x 10 m	BNET19BG	£265.46
20 x 15 m	BNET19BH	£398.19
20 x 20 m	BNET19BI	£530.92
30 x 5 m	BNET19BL	£207.69
30 x 10 m	BNET19BM	£415.38

19 mm STONE

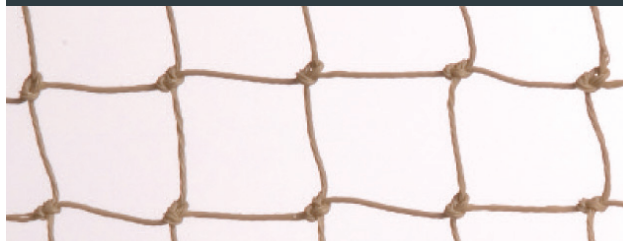

SIZE	ORDER CODE	PRICE
5 x 5 m	BNET19SA	£33.18
10 x 5 m	BNET19SC	£66.37
10 x 10 m	BNET19SB	£132.73
15 x 5 m	BNET19SF	£99.55
15 x 10 m	BNET19SD	£199.10
15 x 15 m	BNET19SE	£298.64
20 x 5 m	BNET19SJ	£132.73
20 x 10 m	BNET19SG	£265.46
20 x 15 m	BNET19SH	£398.19
20 x 20 m	BNET19SI	£530.92

19 mm TRANSLUCENT



SIZE	ORDER CODE	PRICE
5 x 5 m	BNET19TA	£33.18
10 x 5 m	BNET19TC	£66.37
10 x 10 m	BNET19TB	£132.73
15 x 5 m	BNET19TF	£99.55
15 x 10 m	BNET19TD	£199.10
15 x 15 m	BNET19TE	£298.64
20 x 5 m	BNET19TJ	£132.73
20 x 10 m	BNET19TG	£265.46
20 x 15 m	BNET19TH	£398.19
20 x 20 m	BNET19TI	£530.92

19 mm NO-FLAME



SIZE	ORDER CODE	PRICE
5 x 5 m	BNET19NA	£46.85
10 x 5 m	BNET19NC	£93.69
10 x 10 m	BNET19NB	£184.62
15 x 5 m	BNET19NF	£140.54
15 x 10 m	BNET19ND	£281.08
15 x 15 m	BNET19NE	£421.62
20 x 5 m	BNET19NJ	£187.38
20 x 10 m	BNET19NG	£374.77
20 x 15 m	BNET19NH	£562.15
20 x 20 m	BNET19NI	£749.54

50 mm BLACK



SIZE	ORDER CODE	PRICE	SIZE	ORDER CODE	PRICE
5 x 5 m	BNET50BA	£9.76	25 x 15 m	BNET50BL	£150.00
10 x 5 m	BNET50BC	£19.52	25 x 20 m	BNET50BM	£200.00
10 x 10 m	BNET50BB	£39.04	25 x 25 m	BNET50BN	£250.00
15 x 5 m	BNET50BF	£29.28	30 x 5 m	BNET50BV	£60.00
15 x 10 m	BNET50BD	£58.56	30 x 10 m	BNET50BQ	£120.00
15 x 15 m	BNET50BE	£87.84	30 x 15 m	BNET50BR	£180.00
20 x 5 m	BNET50BJ	£39.04	30 x 20 m	BNET50BS	£240.00
20 x 10 m	BNET50BG	£78.08	30 x 25 m	BNET50BT	£300.00
20 x 15 m	BNET50BH	£117.12	30 x 30 m	BNET50BU	£360.00
20 x 20 m	BNET50BI	£156.15			
25 x 5 m	BNET50BP	£50.00			
25 x 10 m	BNET50BK	£100.00			

50 mm STONE

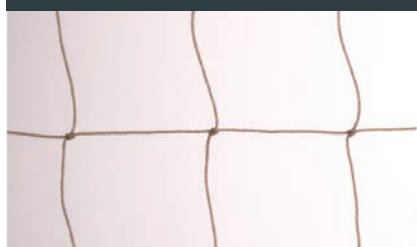

50 mm TRANSLUCENT



50 mm NO-FLAME

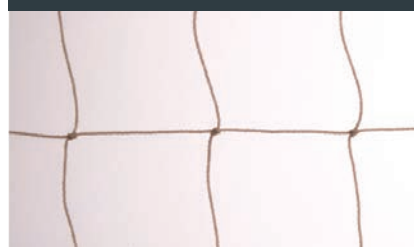

SIZE	ORDER CODE	PRICE	SIZE	ORDER CODE	PRICE	SIZE	ORDER CODE	PRICE
5 x 5 m	BNET50SA	£9.76	5 x 5 m	BNET50TA	£9.76	5 x 5 m	BNET50NA	£15.23
10 x 5 m	BNET50SC	£19.52	10 x 5 m	BNET50TC	£19.52	10 x 5 m	BNET50NC	£30.45
10 x 10 m	BNET50SB	£39.04	10 x 10 m	BNET50TB	£39.04	10 x 10 m	BNET50NB	£60.90
15 x 5 m	BNET50SF	£29.28	15 x 5 m	BNET50TF	£29.28	15 x 5 m	BNET50NF	£45.68
15 x 10 m	BNET50SD	£58.56	15 x 10 m	BNET50TD	£58.56	15 x 10 m	BNET50ND	£91.35
15 x 15 m	BNET50SE	£87.84	15 x 15 m	BNET50TE	£87.84	15 x 15 m	BNET50NE	£137.03
20 x 5 m	BNET50SJ	£39.04	20 x 5 m	BNET50TJ	£39.04	20 x 5 m	BNET50NJ	£60.90
20 x 10 m	BNET50SG	£78.08	20 x 10 m	BNET50TG	£78.08	20 x 10 m	BNET50NG	£121.80
20 x 15 m	BNET50SH	£117.12	20 x 15 m	BNET50TH	£117.12	20 x 15 m	BNET50NH	£182.70
20 x 20 m	BNET50SI	£156.15	20 x 20 m	BNET50TI	£156.15	20 x 20 m	BNET50NI	£243.60

STARLING BIRD NETS

BIRD
control
PRODUCTS

28 mm BLACK



SIZE	ORDER CODE	PRICE
5 x 5 m	BNET28BA	£21.47
10 x 5 m	BNET28BC	£42.94
10 x 10 m	BNET28BB	£85.88
15 x 5 m	BNET28BF	£64.41
15 x 10 m	BNET28BD	£128.83
15 x 15 m	BNET28BE	£193.24
20 x 5 m	BNET28BJ	£85.88
20 x 10 m	BNET28BG	£171.77
20 x 15 m	BNET28BH	£257.65
20 x 20 m	BNET28BI	£343.54

28 mm STONE

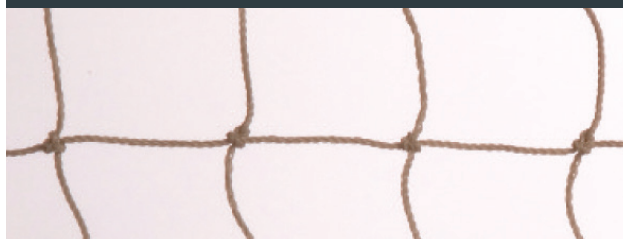

SIZE	ORDER CODE	PRICE
5 x 5 m	BNET28SA	£21.47
10 x 5 m	BNET28SC	£42.94
10 x 10 m	BNET28SB	£85.88
15 x 5 m	BNET28SF	£64.41
15 x 10 m	BNET28SD	£128.83
15 x 15 m	BNET28SE	£193.24
20 x 5 m	BNET28SJ	£85.88
20 x 10 m	BNET28SG	£171.77
20 x 15 m	BNET28SH	£257.65
20 x 20 m	BNET28SI	£343.54

BIRD NETTING - STARLING & GULL NETS

GULL BIRD NETS

BIRD
control
PRODUCTS

75 mm BLACK

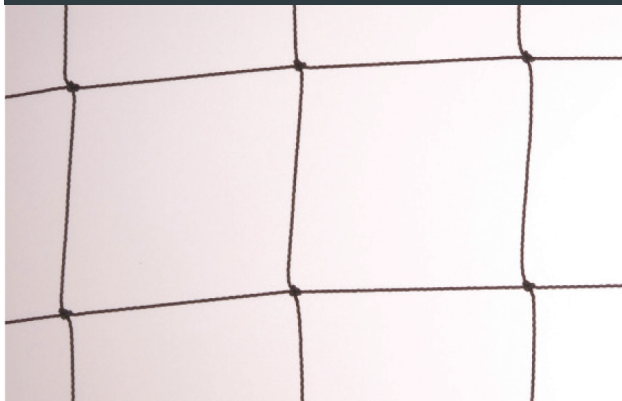

SIZE	ORDER CODE	PRICE
5 x 5 m	BNET75BA	£9.37
10 x 5 m	BNET75BC	£18.74
10 x 10 m	BNET75BB	£37.48
15 x 5 m	BNET75BF	£28.11
15 x 10 m	BNET75BD	£56.22
15 x 15 m	BNET75BE	£84.32
20 x 5 m	BNET75BJ	£37.48
20 x 10 m	BNET75BG	£74.95
20 x 15 m	BNET75BH	£112.43
20 x 20 m	BNET75BI	£149.91

BIRD NET RANGE

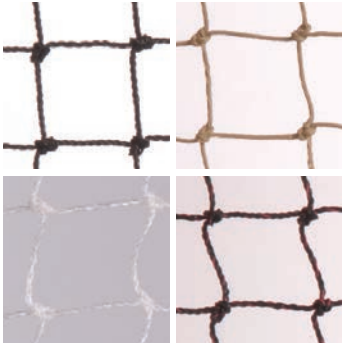

The range of mesh sizes available allows protection against all common species of urban bird pest. Choose from a variety of colours (black, stone and translucent) and no-flame to suit most situations. All Bird Nets have the corners marked with ties and the longest side identified with a label for ease of installation.

MESH	SPECIES	COLOURS	PRICE Black, Stone, Trans.	PRICE No-flame
19 mm (3/4")	House Sparrow	Black, Stone, Translucent & No-Flame	£1.46 m ²	£1.96 m ²
28 mm (1 1/8")	Starling	Black & Stone	£0.92 m ²	N/A
50 mm (2")	Feral Pigeon	Black, Stone, Translucent & No-Flame	£0.47 m ²	£0.60 m ²
75 mm (3")	Herring Gull & Lesser Black-backed Gull	Black	£0.46 m ²	N/A

CUT NETS



All cut nets are priced and cut to whole metre sizes. Please review the T&C's information before ordering this product.

As with the Stock nets, the product codes for Cut Nets make it easy for you to order. For cut nets, the code has a prefix of CUT followed by the mesh size, colour and dimensions of net you require (longest side X shortest side).

For example: For a Translucent 50 mm net of size 8 m x 7 m the code is: BCUT50T8X7

Please ensure that the size is not too big to handle. We do not advise you to handle a net larger than 900 m².

Minimum net size is 1 m x 1 m, and we are unable to cut nets to less than full metre units.

TO AVOID POSSIBLE ERRORS, PLEASE NOTE THAT WE WILL ONLY ACCEPT ORDERS FOR CUT NETS IN WRITING (VIA E-MAIL).

£POA

NO-FLAME NET (19 mm & 50 mm)



Designed to provide a cost-effective and safe solution for bird proofing in areas where people or combustible materials would be at risk, such as over fire escapes, under canopies and in warehouses. There are two main differences between a standard net and a No-Flame Net: whilst a standard net will continue to burn when a flame source is removed and will drop burning pieces of molten plastic; a No-Flame Net shrinks away from a flame reducing the amount of molten debris and minimising fire spread.

No-Flame Bird Net is a knotted polyethylene net made with UV stabilised, flame retarded 12/6 twine that does not absorb water and is chemically inert. It includes a red strand to clearly distinguish it from other nets when bundled but, when correctly installed, this identifier is virtually invisible.

No-Flame Net meets performance specification: BS5867

£POA

NET LABEL



NET LABEL: Advertise your net installation with the Bird Net Label. The PVC net label is weather resistant and can be easily hogringed or cable tied onto your installed net. The label can include: Your company name and/or logo, telephone number, website and/or email address.

The label size is 20 cm by 10 cm. Digitally printed to one side in up to four colours with four holes punched in the corners.

Minimum order: 50

Please contact the sales office for a quotation.

£POA

MASONRY & STEELWORK CORNER FIXINGS

STAINLESS STEEL PROFESSIONAL

MASONRY CORNER FIXINGS



1

For runs of straining wire less than 5 m between Corner Fixings, Mini bolts maybe preferable. For runs of straining wire exceeding 10 m between corner fixings or for exposed horizontal net greater than 20 m, you will need to use the larger M8 Netbolts.



2



3

ORDER CODE	DESCRIPTION	PACK SIZE	PRICE
1: BNET329-10	Netbolt, Welded, M6	10	£32.98
2: BNET124	Minibolt, ring	10	£20.33
3: BNET210	Netbolt, M8	10	£36.43

GALVANISED STEEL PROFESSIONAL

MASONRY CORNER FIXINGS



4

For runs of straining wire less than 5 m between Corner Fixings, Mini bolts maybe preferable. For runs of straining wire exceeding 10 m between corner fixings or for exposed horizontal net greater than 20 m, you will need to use the larger M8 Netbolts.



5



6

ORDER CODE	DESCRIPTION	PACK SIZE	PRICE
4: BNET325-10	Netbolt, M6	10	£12.57
5: BNET128	Minibolt, ring	10	£5.93
6: BNET028	Netbolt, M8	10	£12.01

STAINLESS STEEL PROFESSIONAL

STEELWORK CORNER FIXINGS



1

BEAM BOLT: Used as a corner fixing for attaching netting perimeter wire rope frameworks. Attach to structural steel work such as beams. Use the eye to start and finish runs of wire rope and to hook barrel strainers. Requires a 6 mm hole to be drilled into steelwork and a 10 mm spanner to tighten it. Available in galvanised or stainless steel.

BRIDGE CLAMP: For use on steelwork, girders and undersides of bridges. Can be used on metal up to 20 mm thick.

ORDER CODE	DESCRIPTION	PACK SIZE	PRICE
1: BNET166	Beam Bolt	10	£22.77
2: BBIR020	Bridge Clamp, up to 20 mm	10	£39.59

GALVANISED STEEL PROFESSIONAL

STEELWORK CORNER FIXINGS



3

BEAM BOLT: Used as a corner fixing for attaching netting perimeter wire rope frameworks. Attach to structural steel work such as beams. Use the eye to start and finish runs of wire rope and to hook barrel strainers. Requires a 6 mm hole to be drilled into steelwork and a 10 mm spanner to tighten it. Available in galvanised or stainless steel. **BRIDGE CLAMP:** For use on steelwork, girders and undersides of bridges. Can be used on metal up to 20 mm thick.

ADJUSTABLE BRIDGE CLAMP: For use on steelwork, girders and undersides of bridges. Can be used on metal up to 19-50mm thick."



4

ORDER CODE	DESCRIPTION	PACK SIZE	PRICE
3: BNET076	Beam Bolt	10	£9.70
4: BNET925	Bridge Clamp, up to 20 mm	10	£18.43
5: BNET924	Adjustable Bridge Clamp (19-50 mm)	Each	£13.15

STAINLESS STEEL PROFESSIONAL

CLADDING CORNER FIXINGS



Nylon Cladding Bolts form a secure fastening into thin metal or plastic sheeting. Simply drill a 13 mm hole, push the nylon 'nut' up to its collar into the cladding, then clamp it in place by screwing in the eyebolt - all done from the outside.



ORDER CODE	DESCRIPTION	PACK SIZE	PRICE
1: BNET918	Nylon Cladding Bolt	10	£24.33
2: BNET920	Cladding Bolt, small	10	£24.33
3: BNET921	Pro Cladding Bolt, large	10	£25.83

GALVANISED STEEL PROFESSIONAL

CLADDING CORNER FIXINGS



Nylon Cladding Bolts form a secure fastening into thin metal or plastic sheeting. Simply drill a 13 mm hole, push the nylon 'nut' up to its collar into the cladding, then clamp it in place by screwing in the eyebolt - all done from the outside.

ORDER CODE	DESCRIPTION	PACK SIZE	PRICE
4: BNET922	Cladding Bolt, small	10	£9.45
5: BNET192	20 cm FB Netbolt, with plug	20	£71.05

STAINLESS STEEL PROFESSIONAL

INTERMEDIATE MASONRY FIXINGS

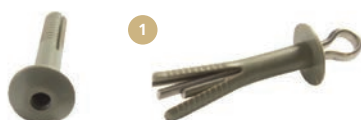

Split Pins with Anchor Rivets offer the most discreet solution. Only use split pins where the straining wire will pull the pin sideways.



ORDER CODE	DESCRIPTION	PACK SIZE	PRICE
1: BBIR311-100	38 mm Anchor Rivet, grey	100	£11.46
2: BBIR314-100	38 mm Split Pin	100	£16.99

GALVANISED STEEL PROFESSIONAL

INTERMEDIATE MASONRY FIXINGS



Split Pins with Anchor Rivets offer the most discreet solution. Only use split pins where the straining wire will pull the pin sideways.

ORDER CODE	DESCRIPTION	PACK SIZE	PRICE
3: BNET132	Wall Plug, red	100	£0.91
4: BNET340-50	Screw Eye	50	£4.67

STAINLESS STEEL PROFESSIONAL

ALTERNATIVE INTERMEDIATE MASONRY FIXINGS



Alternative Intermediate Fixings, selected for appearance, installation time, personal preference or cost.

ORDER CODE	DESCRIPTION	PACK SIZE	PRICE
1: BNET112	Screwpin	100	£34.43
2: BNET038	Screw Eye	100	£24.37
BNET081	Net Spike	100	£46.61
3: BBIR010	25 mm Anchor Rivet, grey	100	£8.17
4: BBIR013	25 mm Split Pin	100	£13.82
BNET133	Wall Plug, brown	100	£1.66

GALVANISED STEEL PROFESSIONAL

ALTERNATIVE INTERMEDIATE MASONRY FIXINGS



Listed below are alternative Intermediate Fixings, which may be selected according to appearance, installation time, personal preference or cost.

ORDER CODE	DESCRIPTION	PACK SIZE	PRICE
5: BNET080	Net Spike	100	£34.18
6: BNET057	Weldmesh Clips, 5 mm hole	50	£26.87
7: BNET132	Wall Plug, red	100	£0.91

STAINLESS STEEL PROFESSIONAL

INTERMEDIATE STEELWORK FIXINGS



For use on steelwork, girders and undersides of bridges.

ORDER CODE	DESCRIPTION	PACK SIZE	PRICE
1: BNET103	Pro Girder Clip, 3-7 mm Hammer on	100	£274.32
2: BNET101	Girder Clip, 8-14 mm Hammer on	100	£281.77
3: BNET105	Girder Clip, 14-20 mm Hammer on	100	£302.27
4: BNET118	Girder Clamp, 50 mm Bolt on	10	£54.70
5: BNET135	Girder Clamp, 75 mm Bolt on	10	£64.87

GALVANISED STEEL PROFESSIONAL

INTERMEDIATE STEELWORK FIXINGS



For use on steelwork, girders and undersides of bridges.

ORDER CODE	DESCRIPTION	PACK SIZE	PRICE
6: BNET100	Girder Clip, 2-3 mm Hammer on	100	£73.94
7: BNET102	Girder Clip, 3-8 mm Hammer on	100	£79.25
8: BNET104	Girder Clip, 8-14 mm Hammer on	100	£86.29
9: BNET106	Girder Clip, 14-20 mm Hammer on	100	£89.81
BNET109	Girder Clip, 10-16 mm	100	£61.79

NET MAGNETS FOR CABLE



Net Magnets come in handy when drilling or screwing is not an option. These magnets are extremely quick to secure in place and can be useful for following contours of a metal substrate with a wire cable. Use Caution as these are not as strong as screwed fasteners. Holds up to 7 kg.

ORDER CODE	DESCRIPTION	PACK SIZE	PRICE
BMPT7610	Net Magnet for Cable	10	£32.25

STAINLESS STEEL PROFESSIONAL

INTERMEDIATE CLADDING FIXINGS

Angle Brackets: are fixed in position using Self Drill Screws or Self Tap Screws.

Bonded Washers: are available to provide a watertight seal under the screw.

Self Drill Screws: are installed using the Hex Drive Socket.

The **Multi-Purpose Cable Bracket** is a versatile stainless steel bracket that is screwed into position. Wire rope can be threaded through the hole or supported over the 'hook'. Barrel Strainers can be hooked into the hole if used as a corner fixing on a small net.

The **Stick-on Fixing** can be glued onto cladding, metals, lead flashing and glass. Ensure **Surface Activator** is used to pre-treat the fixings prior to gluing with **Avifix**.



ORDER CODE	DESCRIPTION	PACK SIZE	PRICE
1: BNET077	Angle Bracket	100	£15.69
2: BNET099	Net Guides	100	£23.06
3: BNET126	20 mm Self Drill Screw	100	£28.95
4: BNET125	25 mm Self Drill Screw	100	£45.91
5: BNET157	Washers, rubber-bonded	100	£7.92
6: BMISO45	Self Tap Screws, no.8	100	£16.76
7: BNET134	Hex Drive Socket	Each	£6.67
8: BNET068	Multi-Use Cable Bracket	100	£30.23

GALVANISED STEEL PROFESSIONAL

INTERMEDIATE CLADDING FIXINGS

As above but made from Galvanised Steel.



ORDER CODE	DESCRIPTION	PACK SIZE	PRICE
9: BNET071	Angle Bracket	100	£8.90
10: BNET122	19 mm Self Drill Screw	100	£8.12
11: BNET121	25 mm Self Drill Screw	100	£3.92
12: BNET075	Stick-on Fixing, grey	10	£2.90

STAINLESS STEEL PROFESSIONAL

BIRD NET BRACKETS

BNET275 - Pro External Corner Fixings Bracket

When running a straining wire around a corner, it can be difficult getting a fixing close to the corner to prevent damaging the straining wire or the building. This new bracket will help to solve this problem. Thanks to the angle of the hole, this bracket can also be used to fit a wire neatly up an outside corner of a building. Fixing holes 6 mm diameter.



BNET277 - Pro Capital Bracket 45 Degrees

This bracket replaces the original Capital Bracket. The angle of the hole allows the straining wire to be run either vertically or horizontally with the same fixing position of the bracket. Fixing holes 8 mm diameter (will accept BNET123 Dynabolt).



BNET278 - Pro 'Net Off' Slider

The Pro 'Net Off' Slider replaces all four previous 'Net Off's'. It will support straining wire 105 mm to 210 mm from the substrate in places where the net needs to be held away from a protrusion to help prevent abrasion damage to the net. Fixing holes 6 mm diameter. Tighten the nuts with 10 mm spanners.



ORDER CODE	DESCRIPTION	PACK SIZE	PRICE
1: BNET275	External Corner Fixings Bracket	Each	£12.54
2: BNET277	Capital Bracket 45 Degrees	Each	£6.73
3: BNET278	'Net Off' Slider	Each	£7.76
BNET123	Dynabolt, M6	10	£20.33
4: BNET282	Internal Corner Bracket	Each	£12.68

STAINLESS STEEL PROFESSIONAL

WIRE ROPE & TENSIONING

2 mm diameter Wire Rope is appropriate for the majority of nets. The Wire Rope allows good flexibility. M6 Barrel Strainers are suitable for most nets. 2.5 mm Copper Ferrules should be used with stainless steel wire. Wire Rope Grips can be used as an alternative to ferrules.



ORDER CODE	DESCRIPTION	PACK SIZE	PRICE
BNET308	Wire Rope, 2 mm diameter	50 m	£17.90
1: BNET008	Wire Rope, 2 mm diameter	200 m	£71.58
2: BNET316A	Barrel Strainer, M6	Each	£3.12
3: BNET321-100	Copper Ferrules, 2.5 mm diameter	100	£10.98
BNET018	Wire Rope Grip	10	£13.85

GALVANISED STEEL PROFESSIONAL

WIRE ROPE & TENSIONING

2 mm diameter Wire Rope is appropriate for the majority of nets. The Wire Rope allows good flexibility. M6 Barrel Strainers are suitable for most nets. 2.5 mm Aluminium Ferrules should be used with galvanised wire. Wire Rope Grips can be used as an alternative to ferrules.



ORDER CODE	DESCRIPTION	PACK SIZE	PRICE
BNET307	Wire Rope, 2 mm diameter	50 m	£9.71
4: BNET007	Wire Rope, 2 mm diameter	200 m	£38.85
5: BNET315-10	Barrel Strainer, M6	10	£9.99
BNET019	Aluminium Ferrules, 2.5 mm diameter	100	£5.82
6: BNET335-20	Wire Rope Grip	20	£4.04

STAINLESS STEEL & GALVANISED

WIRE ROPE CORNER FIXINGS < 5 m



For runs of wire less than 5 meters between Corner Fixings. All products are Stainless Steel unless stated otherwise.

ORDER CODE	DESCRIPTION	PACK SIZE	PRICE
1: BNET149	Wire Rope, 1.2 mm dia. (Light Duty)	100 m	£20.86
2: BNET073	Ferrules, 1.5 mm diameter	100 m	£9.06
3: BNET305	Barrel Strainer, M4	Each	£4.14
4: BNET314	Pro Barrel Strainer, M5	Each	£5.50
5: BNET313-10	Barrel Strainer, M5 (Galvanised Steel)	10	£5.47

STAINLESS STEEL PROFESSIONAL

WIRE ROPE CORNER FIXINGS >10 m / EXPOSED HORIZONTAL NET >20 m



In some circumstances where the length of wire rope exceeds 10 m or for exposed horizontal net greater than 20 m, it may not be feasible to fit a corner fixing in the middle of the wire rope span. Therefore it is important that you choose the fixings and wire rope that are strong enough to hold the weight of the net.

ORDER CODE	DESCRIPTION	PACK SIZE	PRICE
1: BNET089	Wire Rope, 3 mm diameter	100 m	£40.33
2: BNET326	Barrel Strainer, M8	Each	£4.18
3: BNET018	Wire Rope Grip	10	£13.85

GALVANISED STEEL PROFESSIONAL

WIRE ROPE CORNER FIXINGS >10 m / EXPOSED HORIZONTAL NET >20 m



As above but manufactured from Galvanised Steel.

ORDER CODE	DESCRIPTION	PACK SIZE	PRICE
4: BNET083	Wire Rope, 3 mm diameter	100 m	£18.11
5: BNET330-10	Barrel Strainer, M8	10	£13.59
6: BNET335-20	Wire Rope Grip	20	£4.04
BNET049	Nut Spinner	1	£13.79

WIRE REEL HOLDER



The Wire Reel Holder has been specifically designed to hold wire rope reels for bird work. It allows you to pull off the wire as required to help avoid wire tangling or reels rolling away. The reel simply drops on to the centre spindle, and the retaining pin clips in place to hold it on. This handy tool can save you a lot of installation time and frustration.

ORDER CODE	DESCRIPTION	PACK SIZE	PRICE
BNET208	Wire Reel Holder	Each	£24.98

ROOF NET FIXINGS

STAINLESS STEEL PROFESSIONAL

ROOF CORNER & INTERMEDIATE BRACKETS

These sturdy stainless steel Dormer Brackets are designed to look acceptable above dormer windows on private houses, but they can also be used in a variety of other situations, such as on parapet walls. Pigeon and Gull brackets are available, and Dynabolts should be used to secure the brackets in place.



ORDER CODE	DESCRIPTION	PACK SIZE	PRICE
BNET270	Corner Bracket, Pigeon, 240 mm	Each	£35.90
BNET271	Intermediate Bracket Pigeon, 240 mm	Each	£26.75
1: BNET272	Corner Bracket, Gull, 360 mm	Each	£40.46
2: BNET273	Intermediate Bracket, Gull, 360 mm	10	£34.99
3: BNET123	Pro Dynabolt, M6	Each	£20.33

STAINLESS STEEL PROFESSIONAL

ROOF INTERMEDIATE FIXINGS

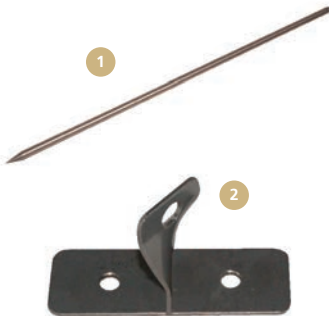

Stainless steel Roof Spikes are designed to hold the wire rope above roof ridges. These spikes are hammered through the mortar between the ridge tiles into the wooden joist below. The rod is 520 mm in length, 10 mm in diameter, with a 3 mm hole in the top for the straining wire. The holes can be weatherproofed with a Roof Spike Seal and glued in place with Avifix. The Two Way Slate Bracket slips between adjoining slates to hold the wire rope close to the surface of the roof. It is designed to allow the wires to be attached horizontally or vertically.

ORDER CODE	DESCRIPTION	PACK SIZE	PRICE
1: BNET190	Roof Spike, 520 mm	Each	£11.17
2: BNET274	Two Way Slate Bracket	10	£21.21

STAINLESS STEEL PROFESSIONAL

ROOF RIDGE FIXINGS



This Bracket holds the straining wire above a roof ridge. Half-Round Ridge Brackets rods on the brackets are 450 mm in height. Half-Round Brackets are designed to clamp under the edge of the ridge tiles.

ORDER CODE	DESCRIPTION	PACK SIZE	PRICE
BNET183	Half-Round Ridge Net Bracket	Each	£15.88

ROOF INTERMEDIATE FIXINGS



Increasingly, large roofs are being proofed to protect against pigeons and gulls. In most circumstances, it is not feasible to drill into the roof itself, so net supports that can be weighted down are required. As no two roofs are the same, the supports need to be adaptable to fit different roof shapes, angles and obstacles.

The patented Roof Mount far exceeds these criteria. It is light-weight, very easy to handle, extremely versatile and allows fast installation.



ORDER CODE	DESCRIPTION	PACK SIZE	PRICE
BNET950	Roof Mount Base Includes: Includes: 1 x Main assembly (2x hips 1 upright support, 2x end caps, 1 clamping rod) 4x Feet & 10 x 19mm self drill screws	Each	£88.35
BNET951	Roof Mount Legs Includes: 4x Legs (0.55 m)	Each	£45.50
BNET952	Roof Mount 1 m Upright Includes: 1x 1m Pole & 1x Sleeve	Each	£36.40
BNET953	Roof Mount 2 m Upright Includes: 1x 2 m Pole & 1x Sleeve	Each	£45.50
BNET960	For Standing Seam Ridges	Each	£19.64

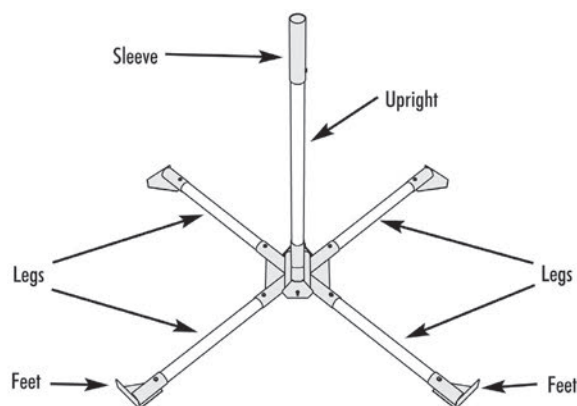
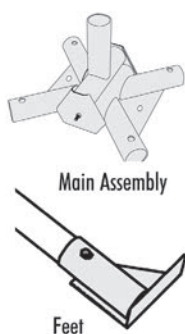
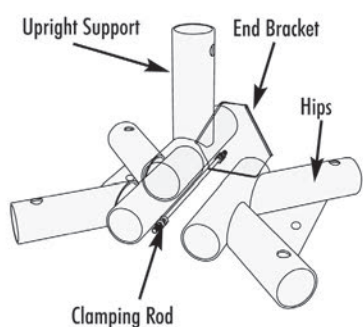

GULL PARALLEL WIRE ROOF SYSTEMS

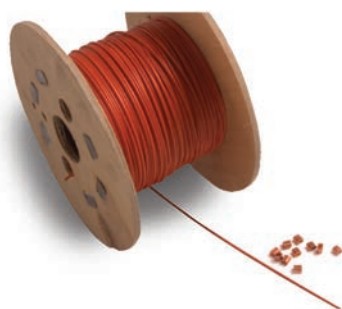

An alternative to a roof net installation for gulls is to use the same brackets and same perimeter straining wire as for a net installation, but to fit a series of parallel orange coated 1.2 mm wires instead of a net.

ORDER CODE	DESCRIPTION	PACK SIZE	PRICE
BNET926	Wire Rope, 1.2 mm orange	100 m	£42.36
BNET321-100	Copper Ferrules, 2.5 mm diameter	100	£10.98

NET CLIPS, ZIPS & STAPLES

NET CLIPS

Bird Net Clips are made from stainless steel, blend well into the net and are easy to install. Sometimes access is required through netting for maintenance or cleaning.

To help other contractors carry out this work, access systems can be installed into the net at appropriate points.



ORDER CODE	DESCRIPTION	NET MESH	PACK SIZE	PRICE
BNET167	Net clips, small	19 mm	100	£18.35
BNET169	Net clips, large	50 mm	100	£30.23

NET ZIPS

Bird Net Zips are made entirely of non-corroding materials and are very robust. They are easier to open and close than net clips, but are more noticeable in the net. They are available in two sizes: No. 10 size for 19 mm and 50 mm mesh net and No. 5 size for 28 mm mesh net. The zips can be stitched into the net with repair twine, or they can be hog-ringed in.



ORDER CODE	DESCRIPTION	NET MESH	PACK SIZE	PRICE
BNET144	No.9 size, 1 m Black	19 mm/50 mm	Each	£6.64
BNET145	No.9 size, 2 m Black	19 mm/50 mm	Each	£7.45
BNET155	No.9 size, 3 m Black	19 mm/50 mm	Each	£10.62
BNET148	No.9 size, 4 m Black	19 mm/50 mm	Each	£13.49
BNET152	No.9 size, 1 m Stone	19 mm/50 mm	Each	£5.57
BNET153	No.9 size, 2 m Stone	19 mm/50 mm	Each	£7.87
BNET141	No.5 size, 1 m Black	28 mm	Each	£4.37
BNET147	No.5 size, 1 m Stone	28 mm	Each	£7.18

STAINLESS STEEL PROFESSIONAL HOGRING STAPLES

Hogring Staples are key to fixing the net to the wire rope. Hogring Staples are installed using the Hogring Staplers.



ORDER CODE	DESCRIPTION	PACK SIZE	PRICE
1: BNET012	Hogring Staples	2500	£43.60
2: BNET900	Marine Hogring Staples	2500	£51.24

HOGRING STAPLES

Hogring Staples are key to fixing the net to the wire rope. Hogring Staples are installed using the Hogring Staplers.



ORDER CODE	DESCRIPTION	PACK SIZE	PRICE
BNET010	Hogring Staples, Galvanised steel	100	£7.57
BNET011	Hogring Staples, Aluminium	100	£23.03
BNET228	Pneumatic Hogring Staples s/s	10,000	£167.40
BNET009	Hogring Stapler, P7 (Stanley Bostich)	Each	£62.49

CABLE TIES & S-CLIPS



CABLE TIES: Manufactured from rugged nylon 66 material, the ties simply wrap around the bird spike strip and the object to which they are being attached and pull tight. Any excess protruding cable tongue can be snipped off for neatness and to attach to bird spikes to bulkier items, the cable ties can be daisy chained together to form a longer strap.

S-CLIPS: Moulded black HDPE plastic clip, UV stabilised for outdoor use as either a netting to perimeter fixing or netting access / repair fixing allowing the net to be easily demounted for access and servicing procedure on equipment that may be behind the net.

ORDER CODE	DESCRIPTION	PACK SIZE	PRICE
BMIS032	Cable Ties 200 mm	100	£7.35
BMIS033	Cable Ties 432 mm	100	£11.17
BNET350	S Clips	200	£7.73

NET REPAIR TWINE

Bird Net Repair Twine can be used for repairing holes or for sewing in zips.



ORDER CODE	DESCRIPTION	LENGTH	PRICE
BNET070	Net Repair Twine, Black, 12/6	150 m	£3.12

NEW

SCREW EYE DRIVER



The Screw Eye Driver is a small attachment used for installing Screw Eyes into wood surfaces. The Screw Eye Driver attaches into the chuck of a hand drill for fast and easy installation. Use to quickly install Screw Eyes into wood surfaces.

ORDER CODE	DESCRIPTION	PACK SIZE	PRICE
BNET036	Screw Eye Driver	Each	£23.36

HOGRING STAPLER



Hogring staplers are essential tools for fixing the net to the Wire Rope. The Pro Hogring Stapler, P7 is designed for speedy one-hand operation and holds 50 Hogring Staples.

ORDER CODE	DESCRIPTION	PACK SIZE	PRICE
BNET009	Hogring Stapler, P7 (Stanley Bostich)	Each	£62.49

RATCHET CRIMPING TOOL



The Pro Ratchet Crimping Tool is specially designed for crimping 2.5 mm ferrules to the Wire Rope.

ORDER CODE	DESCRIPTION	PACK SIZE	PRICE
BNET022	Ratchet Crimping Tool	Each	£112.63

FELCO C7 WIRE CUTTERS & N7 WIRE CUTTERS



The heavy-duty Pro Felco C7 Wire Cutters are ideal for regular use and essential to ensure the Wire Rope is cut cleanly. The N7 Wire Cutters are ideal for the 'one-off' job but are not recommended for regular usage.

ORDER CODE	DESCRIPTION	PACK SIZE	PRICE
1: BNET050	Felco C7 Wire Cutters	Each	£71.07
2: BNET171	N7 Wire Cutters	Each	£31.23

NET SHEARS



Heavy-duty sprung Net Shears with stainless steel blades are a valuable tool for cutting and trimming nets.

ORDER CODE	DESCRIPTION	PACK SIZE	PRICE
BNET136	Net Shears	Each	£8.03

NUT SPINNER

The 7 mm Nut Spinner should be used when tightening Wire Rope Grips.



ORDER CODE	DESCRIPTION	PACK SIZE	PRICE
BNET049	Nut Spinner, 7 mm	Each	£13.79

DRIVE SOCKETS

These Drive Sockets are designed for quick installation of Screwpins, Screw Eyes and Self Drill Screws respectively.



ORDER CODE	DESCRIPTION	PACK SIZE	PRICE
1: BNET207	Screwpin Drive Socket	Each	£10.29
2: BNET134	Hex Drive Socket	Each	£6.67

DRILL BITS

SDS MASONRY DRILL BITS FOR USE WITH SDS DRILLS

Professional installers should use either 110 V drills or battery drills. More powerful drills are available. Special Direct System (SDS) drills use drill bits with fluted ends that allow power to be transferred to the drill bit more efficiently than standard chucks.

Listed below is the choice of drill bits available together with the appropriate fixing.



ORDER CODE	DESCRIPTION	PACK SIZE	USE WITH	PRICE
BDR1020-10	SDS 4.8 mm x 50mm	10	Net Spike	£24.52
BDR1020	SDS 4.8 mm x 50 mm	Each	Net Spike	£2.45
BDR1022	SDS 6.0 mm x 110 mm	Each	Plastic Net Hanger, Screw Pin, Screw Pin Screw Eye, Birdwire Drilled Rods	£2.19
BDR1024	SDS 6.5 mm x 110 mm	Each	Anchor Rivet 25 mm, Anchor Rivet 38 mm, Birdwire Bird Posts	£2.62
BDR1026	SDS 8.0 mm x 110 mm	Each	Minibolt, Dynabolt, M6	£2.84

BIRD SPIKES

AVIPOINT™ P14



Bird activity: Pigeons (Daytime perching)
Infestation: Up to medium pressure areas.
Where to use: Pipework and narrow ledges.
Protects area: Up to 115 mm.

Base width: 20 mm
Distance between wires: 50 mm
Height: 115 mm
Distance between outer spike tips: 50 mm

ORDER CODE	DESCRIPTION	PACK SIZE	PRICE
BAV1110	AVIPOINT P14	5 m Stack	£21.60
BAV1110.1	AVIPOINT P14-Carton	50 m	£191.38
BAV1116.1	AVIPOINT P14-Carton (Marine Grade)	50 m	£265.02

AVIPOINT™ P20



Bird activity: Pigeons (Daytime perching & night time roosting)
Infestation: Up to heavy pressure areas.
Where to use: Most building ledges.
Protects area: Up to 205 mm.

Base width: 45 mm
Distance between wires: 33 mm
Height: 129 mm
Distance between outer spike tips: 140 mm

ORDER CODE	DESCRIPTION	PACK SIZE	PRICE
BAV1120	AVIPOINT P20	5 m Stack	£26.84
BAV1120.1	AVIPOINT P20-Carton	50 m	£236.93
BAV1126.1	AVIPOINT P20-Carton (Marine Grade)	50 m	£329.28

AVIPOINT™ P32



Bird activity: Pigeons & Starlings (Perching, roosting & some nesting)*
Infestation: Up to heavy pressure areas.
Where to use: Most building ledges.
Protects area: Up to 265 mm.

Base width: 45 mm
Distance between wires: 21 mm
Height: 139 mm
Distance between outer spike tips: 200 mm

*For starlings place at least three strips together with wires overlapping

ORDER CODE	DESCRIPTION	PACK SIZE	PRICE
BAV1130	AVIPOINT P32	5 m Stack	£33.17
BAV1130.1	AVIPOINT P32-Carton	50 m	£292.87
BAV1136.1	AVIPOINT P32-Carton (Marine Grade)	50 m	£406.92

AVIPOINT™ G20



Bird activity: Gulls (Perching, roosting & some nesting)*
Infestation: Up to heavy pressure areas.
Where to use: Most building ledges.
Protects area: Up to 375 mm.

Base width: 45 mm
Distance between wires: 33 mm
Height: 166 mm
Distance between outer spike tips: 175 mm

*Due to gulls strength installations need to prevent birds from landing adjacent to areas being protected.

ORDER CODE	DESCRIPTION	PACK SIZE	PRICE
BAV1140	AVIPOINT G20	5 m Stack	£30.86
BAV1140.1	AVIPOINT G20-Carton	50 m	£272.43
BAV1146.1	AVIPOINT G20-Carton (Marine Grade)	50 m	£377.61

AVICLIPS FOR GUTTERS

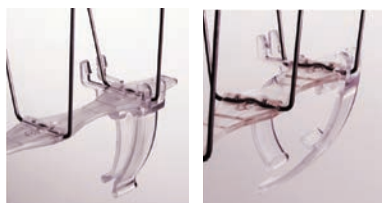

Aviclips for Gutters fit securely onto the base of Avipoint™ P14, P20, P32 and G20 Bird Spikes. The Aviclips for Gutters allows the spike strips to be clipped onto the side of a wide variety of different types of gutters, allowing free flow of water underneath. Two clips are required per Avipoint™ strip.

Aviclips for Lipped Gutters fit securely onto the base of Avipoint™ P14, P20, P32 and G20 Bird Spikes. They allow the spike strips to be clipped onto the side of a variety of lipped gutters, including many international style gutters, allowing free flow of water underneath. Two clips are required per Avipoint™ strip.

ORDER CODE	DESCRIPTION	PACK SIZE	PRICE
BAVI162	Aviclips for Gutters	10	£3.78
BAVI163	Aviclips for Lipped Gutters	10	£3.83

AVICLIPS FOR WINDOWS



Aviclips for Windows fit securely onto the base of Avipoint™ P20, P32 and G20 Bird Spikes. They allow the spike strips to be easily secured onto window frames using Avifix White adhesive or screws. These clips are extremely useful as they allow the spikes to protect the window sill without hindering the operation of the window. Two clips are required per Avipoint™ strip.

ORDER CODE	DESCRIPTION	PACK SIZE	PRICE
BAVI171	Aviclips for Windows	10	£4.87

AVICLIPS FOR BEAMS



Aviclips for Beams fit securely onto the base of Avipoint™ P14, P20, P32 and G20 bird spikes. They allow the spike strips to be clipped onto beams up to 35 mm thick and 40 mm to 230 mm deep. The clips should be used where you cannot glue the Avipoint™ Bird Spikes onto the Beam. The clips and attached spikes can be removed if access to the beam is required for maintenance, cleaning or painting. Two clips are required per Avipoint™ strip.

ORDER CODE	DESCRIPTION	PACK SIZE	PRICE
BAVI181	Aviclips for Beams	10	£3.83

AVICLIPS FOR SOLAR PANELS



Designed to fit both solar panels and roof ridges it is easily glued or screwed in to place. Avipoint clips securely into place and is compatible with P14 and P20, P32 & G20.

Made from a UV stable polycarbonate material which is compatible with 90°, 105° and 125° roof tiles and compatible with both 45° and 37.5° solar panels.

ORDER CODE	DESCRIPTION	PACK SIZE	PRICE
BAVI191	Aviclips for Solar Panels	10	£3.97

Barrettine
Environmental Health



Guanaway

Concentrate & RTU Trigger Spray

Heavy Duty
Alkaline Cleaner Disinfectant

A concentrate and ready to use professional spray for use in the control of microorganisms associated with the cleaning up of bird waste. Guanaway passes BS6471 against *E. coli* and contains a powerful degreaser to neutralise the acid deposits associated with bird droppings.



Barrettine
Guanaway
Concentrate Heavy Duty Alkaline Cleaner Disinfectant

Ideal for use to control microorganisms associated with the clean up of bird waste. Cleaning operators run the risk of inhaling microorganisms associated with bird waste, e.g. paratyphoid, histoplasmosis, salmonellosis, E. coli and other serious diseases.

Passes BS6471 against *E. coli*
Dilution rate: 1-125

By treating benches, during and after use with Guanaway Concentrate the risk to users, when they sit down, to have been exposed to a high number of Customer Concentrate is a powerful alkaline disinfectant which neutralises the acids by products associated with bird droppings. This work and increases safety by reducing the highly greasy waste.

Barrettine
Environmental Health
Unit 10, The Gateway, The Gateway Business Park, B70 8JL
Tel: 01202 322222 Fax: 01202 322222

5 l

Barrettine
Guanaway
Professional Spray for Ready to Use
the cleaning of bird waste

A ready to use professional spray for use in the control of microorganisms, associated with the cleaning up of bird waste and collection of pet bottles.

Guanaway passes BS6471 against *E. coli* and contains a powerful degreaser to neutralise the acid associated with bird droppings.

Wear gloves when using this product, prevent breathing in spray and avoid all contact with skin and eyes. In case of accidental contact, rinse immediately and seek medical attention.

Barrettine
Environmental Health
Unit 10, The Gateway, The Gateway Business Park, B70 8JL
Tel: 01202 322222 Fax: 01202 322222

750 ml

BIRD STOPPER



The SnapFast BirdStopper is an easy to fit and effective solution for preventing birds from accessing the underside of solar panels.

The unique clip-on solution allows the pest controller to pre-cut the desired lengths, then simply clip the product into place. This minimizes the amount of time the pest controllers needs to spend working from heights - no more cutting and screwing whilst on the rooftops.

Unlike some other solutions, it is also easy to remove and re-attach which allows easy access for maintenance of the panels. Made from sturdy recycled plastic.

ORDER CODE	DESCRIPTION	PACK SIZE	PRICE
BBIRSTOP	Bird Stopper 1.4 m	10	£187.23
BBIRCORN	Bird Stopper Corners	8	£107.75
BBIRBRAC	Bird Stopper Metal Brackets	12	£13.48

SURFACE PREPARATION



Primer 150 - For treatment of porous surfaces, such as sandstone, prior to gluing on AVIPOINT.™

Surface Activator - Surface Activator is a cleaner, degreaser and primer all-in-one. It will activate non-porous surfaces such as plastics, coatings and metals for improved adhesion of Avisil and Avifix adhesive. You will not require our Surface Cleaner if you are using Surface Activator.

ORDER CODE	DESCRIPTION	PACK SIZE	PRICE
BADH004	Primer 150	1 x 1 Litre	£60.59

GUANAWAY & GUANAWAY RTU

BUY 3
RTU
GET 1
FREE
25% OFF



Disinfectant and cleaner. Contains didecyldimethylammonium chloride for use with the cleaning up of bird waste. Unlike other products, Guanaway is a powerful alkaline cleaner degreaser that neutralises the acidic by-product associated with bird droppings. This reduces the corrosion to the stonework and increases safety by removing the slippery, greasy waste. Also available as a handy RTU trigger spray version ideal for those small jobs when making up a full sprayer isn't justified. Ideal for disinfecting traffic lights, won't discolour plastic.

ORDER CODE	DESCRIPTION	PACK SIZE	PRICE
BGUANRTU	RTU Trigger Spray 750 ml	Each	£8.75
BGURTBP	RTU Bulk Pack 750 ml	6	£41.54
BDISB005	Concentrate	1 x 5 Litre	£39.80

PIGEON BIRD WIRE & POSTS

BIRD WIRE FOR PIGEONS



Bird Wire is made from stainless steel, diameter 0.45 mm and coated to 0.7 mm with UV stabilised nylon.

ORDER CODE	DESCRIPTION	PACK SIZE	PRICE
1: BBIR001	Pigeon Birdwire	100 m	£19.21
2: BBIR002	Pigeon Birdwire	300 m	£57.64
3: BBIR003	Pigeon Birdwire	500 m	£96.07

BIRD POSTS & FIXINGS

All Bird Posts are made from stainless steel and are installed by knocking them into the nylon Anchor Rivets. Split Pins are used instead of Bird Posts in circumstances where you have a vertical wall at the end of a wire; these are also inserted into the Anchor Rivets.

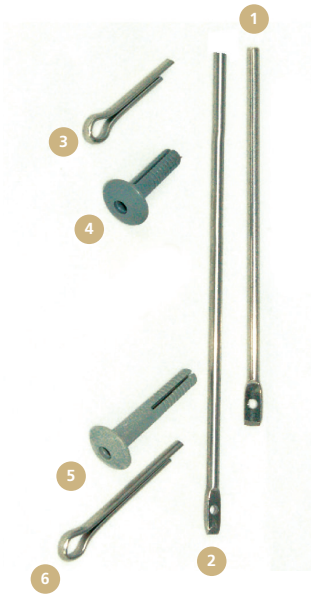

ORDER CODE	DESCRIPTION	PACK SIZE	PRICE
1: BBIR004	Bird Post, 120 mm x 4 mm	100	£43.66
2: BBIR005	Bird Post, 150 mm x 4 mm	100	£48.58
3: BBIR013	Split Pin, stainless steel, 25 mm	100	£13.82
4: BBIR010	Anchor Rivets, grey, 25 mm	100	£8.17
5: BBIR311-100	Anchor Rivets, grey, 38 mm	100	£11.46
6: BBIR314-100	Split Pin, stainless steel, 38 mm	100	£16.99

DOUBLE & TRIPLE HEADED BIRD POSTS



When installing Bird Wire to the top of signs and metal fittings, Threaded Bird Posts can be used. Double-Headed Bird Posts 130 mm are for medium pressure infestations. Double-Headed Posts 150 mm and Triple Headed Bird Posts are used for horizontal installations.

ORDER CODE	DESCRIPTION	PACK SIZE	PRICE
1: BBIR028	Double Hd Bird Post 130 mm x 4 mm	100	£60.43
2: BBIR031	Double Hd Bird Post 150 mm x 4 mm	100	£63.87
3: BBIR036	Triple Hd Bird Post 180 mm x 4 mm	100	£83.76

DRILLED RODS



Drilled Rods are used for horizontal installation to protect wide ledges. They are installed above the ledge you are proofing and can carry a number of wires.

ORDER CODE	DESCRIPTION	PACK SIZE	PRICE
1: BBIR015	295 mm x 6 mm (4 holes)	10	£29.44
2: BBIR027	360 mm x 6 mm (5 holes)	10	£37.32
3: BBIR170	490 mm x 6 mm (7 holes)	10	£46.13

STICK-ON BIRD POSTS

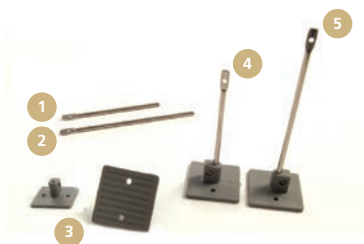

Stick-on Bird Posts are used on metal flashing, cladding and other areas where you are unable to drill. The posts are mounted in a nylon base which can be glued or screwed into place.

ORDER CODE	DESCRIPTION	PACK SIZE	PRICE
1: BBIR024	Bird Posts, 95 mm x 4 mm	100	£41.94
2: BBIR033	Bird Posts, 125 mm x 4 mm	100	£46.81
3: BBIR007	Stick-on Plastic Base, grey	10	£5.11
4: BBIR008	Stick-on Post with base, 95 mm	10	£10.54
5: BBIR006	Stick-on Post with base, 125 mm	10	£11.40

CLAMPS AND BRACKETS

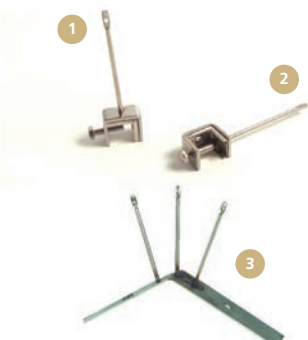

Gutter Posts are for clamping Bird Wire onto vertical flanges and gutters. The Beam Clamps are designed for horizontal flanges, girders and beams. Triangular and Half-Round Ridge Brackets are used to proof roof ridges with Bird Wire. Both can be secured with Blind Anchor Rivets and Avifix.

ORDER CODE	DESCRIPTION	PACK SIZE	PRICE
1: BBIR019	Gutter Post 95 mm x 4 mm	10	£46.46
2: BBIR026	Beam Clamp & Post 95 mm x 4 mm	10	£46.46
3: BBIR042	Triangular Ridge Bracket 3 posts	Each	£8.98
BBIR043	Half-Round Ridge Bracket 3 posts	Each	£12.21

SPRINGS, CRIMPS AND TOOLS

Bird Wire Springs are made from stainless steel, and Crimps from nickel plated copper.

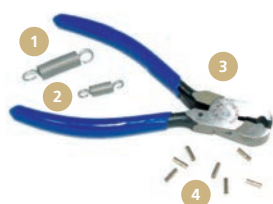

ORDER CODE	DESCRIPTION	PACK SIZE	PRICE
1: BBIR009	Birdwire Standard Spring	100	£17.74
2: BBIR040	Birdwire Micro Spring	100	£17.49
3: BBIR012	Birdwire Crimps	100	£5.93
4: BBIR018	Birdwire Crimp & Cutter Tool	Each	£29.20

PIGEON / GULL BIRD WIRE & POSTS

RAIL CLAMPS



Rail Clamps a popular way of supporting Bird Wire on rails and pipes. These new two-part Rail Clamps and Rail Clamp Posts allow more functionality: You can fasten the clamp tightening screw in any position that best suits the installation; the Rail Clamp Posts can be used separately for installation onto cladding by screwing in place through the 5 mm fixing hole in the base.

ORDER CODE	DESCRIPTION	PACK SIZE	PRICE
BBIR171	Pigeon Rail Clamp post	10	£19.49
BBIR172	Gull Rail Clamp post	10	£35.76
BBIR174	Rail Clamp, 45 - 60 mm dia.	10	£32.40
BNET049	7 mm Nut Spinner	Each	£13.79

GULL WIRE, SPRINGS AND CRIMPS



The same basic principals as for pigeons are followed for Gulls, but heavier-duty components are required.



ORDER CODE	DESCRIPTION	PACK SIZE	PRICE
BNET087	Gullwire, 0.96 mm diameter	200 m	£50.48
BBIR040	Birdwire Micro Spring	100	£17.49
BNET079	Ferrules, Copper, 1 mm (for 0.96 mm wire)	100	£9.18

GULL POSTS AND FIXINGS



For Black Headed Gulls use the 180 mm x 4 mm Gull Posts.

ORDER CODE	DESCRIPTION	PACK SIZE	PRICE
BBIR035	Gull Posts, 180 mm x 4 mm	100	£51.59
BBIR013	Split Pin, stainless steel, 25 mm	100	£13.82
BBIR010	Anchor Rivets, grey, 25 mm	100	£8.17
BBIR311-100	Anchor Rivets, grey, 38 mm	100	£11.46
BBIR314-100	Split Pin, stainless steel, 38 mm	100	£16.99

GULL RIDGE BRACKETS



Both brackets have three Gull posts attached.

ORDER CODE	DESCRIPTION	PACK SIZE	PRICE
BBIR161	Triangular Gull Ridge Bracket	Each	£9.29
BBIR163	Half-Round Gull Ridge Bracket	Each	£10.74

ENERGISERS

SMALL



LARGE



The Energiser sends a pulse of electricity along the Avishock™ track every 1.3 seconds. The pulse lasts only a fraction of a second and is indicated by a quiet click and a small flashing light. The energisers are powered simply by plugging them into a power socket.

For added safety, all energisers are supplied with a detachable lead so it can be removed when the system is being worked on. Energisers must be installed in an upright position.

The Small Energiser is designed for a run of Flex-Track up to 150 m. The Large Energiser is designed for Flex-Track runs between 150 m and 300 m.

The Small Energiser is designed for a run of Flex-Track up to 150 m.

The Large Energiser is designed for Flex-Track runs between 150 m and 300 m.

ORDER CODE	DESCRIPTION	PACK SIZE	PRICE
BSHK040	Small Energiser	Each	£148.19
BSHK120	Large Energiser	Each	£179.39

AVISHOCK TRACK

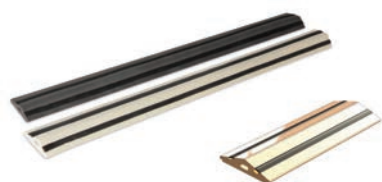

The unique Avishock track is supplied in 20 m lengths and offers simple installation from an easy to handle reel. The UV stable track incorporates copper strips, covered by a conductive plastic cover, protecting the strips from weather and corrosion.

Avishock™ track is available in two colours to match most common buildings.

ORDER CODE	DESCRIPTION	PACK SIZE	PRICE
BSHK101	Stone	20 m	£195.24
BSHK102	Black	20 m	£195.24

CONNECTORS

BSHK121



BSHK122



BSHK123



BSHK129



Avishock™ straight and corner connectors are very easy to install and provide a strong connection between track pieces on corners or on track joins.

ORDER CODE	DESCRIPTION	PACK SIZE	PRICE
BSHK121	Straight Connectors	20	£64.66
BSHK122	Corner Connectors	20	£64.66
BSHK123	Jumper Connector	20	£36.95
BSHK023	Female Spade Connectors	100	£17.60
BSHK129	Male Spade Connectors	100	£17.60

AVISHOCK LEAD WIRE & SEALANTS

LEAD WIRE & WIRE GUIDES



Lead wire is supplied in 20 m reels and is available in two colours to compliment your track choice. The heavy insulated copper, is easy to cut, strip and crimp. A choice of wire guides is available for different applications. Wire guides hold the wire in place, creating a neat and visible installation.

Quick guide - Lead Wire: Is used to transfer power from an Energiser to the track or from one section of track to another- Screw in wire guides: Easily secured using a self-tap screw, these guides are lower profile so more discreet and are ideal for installations on stone.

ORDER CODE	DESCRIPTION	PACK SIZE	PRICE
BSHK112	Lead Wire, Black	20 m	£46.92
BSHK031	Wire Guides, Screw-in	100	£9.71

SOULDAL SEALANTS



The Soudal range offers a sealant to be used in a variety of situations. Whether applied on different surfaces or in different conditions there will be a sealant suitable to the conditions.

ORDER CODE	DESCRIPTION	PACK SIZE	PRICE
BADHSIL2	Silirub 2	300 ml	£3.50
BADHFTUR	Fix all Turbo	290 ml	£6.25
BADHFXTR	Fix all X-treme	290 ml	£5.23
BADHFAGR	Fix all Grey	290 ml	£4.68

AVISIL & AVIFIX HIGH TACK

AVISIL

For use with a caulking gun, this is a professional product that cannot be found in DIY shops. Avisil is vastly superior to ordinary clear DIY silicone due to it's ease of application, it stays permanently elastic after curing, Avisil has a high temperature resistance and UV resistance. A clear, high quality, neutral-curing silicone adhesive, Avisil is recommended for use where the surface is dry. It offers excellent adhesion on most building materials. One tube (310 ml) of Avisil can install up to 15 m of Avipoint Bird.

AVIFIX HIGH TACK

For use with a caulking gun, this is a professional product that is superior to general purpose high tack adhesives, found in DIY shops. This is due to it's flexible elastic rubber movement, which accommodates up to 20 %, and because it gives primerless adhesion even on damp surfaces. A multipurpose, high tack adhesive. Avifix "High Tack" can be used for fixing AVIPOINT™ Bird Spikes where the surface is damp. It offers outstanding initial grab and excellent adhesion on most building materials such as brick, stone, metal, glass, wood, PVC, GRP and nylon.



BUY 11 GET 1 FREE
10% OFF

ORDER CODE	DESCRIPTION	PACK SIZE	PRICE
BADH001	Avisil	310 ml	£4.26
BADH006	Avifix Grey	290 ml	£6.68
BADH010	Avifix White	290 ml	£6.68
BADH027	Adhesive Tube Cutter	Each	£20.63

TOOLS & WARNING SIGNS

1



2



3



4



The Digital Voltage Tester is required to ensure that the system is sending the correct amount of electricity. Solid connections are a must for a long-lasting installation. - Use the middle setting (1.5-2 mm) (Blue) of the Connector Crimp Tool to deliver the perfect crimp. The Wire Stripping Tool easily strips lead wires. Use the 2.6 mm setting and strip 10 mm from the end of the lead wire. - Avishock™ Track Shears are a valuable tool for cutting the Avishock™ track and lead wire.

Warning signs should be positioned wherever a person may gain access to the system or at 5 m intervals on an open wall. Hard wearing rigid Warning Plates can be glued or screwed to the ledge or side of the building. Double sided Window Warning Stickers should be stuck onto a window if the sill or ledge associated to it is protected with AVISHOCK.

ORDER CODE	DESCRIPTION	PACK SIZE	PRICE
1: BSHK051	Digital Voltage Tester	Each	£79.17
2: BSHK052	Connector Crimp Tool	Each	£70.35
3: BSHK053	Wire Stripping Tool	Each	£61.57
4: BSHK136	Connector Avishock Shears	Each	£13.96
BSHK032	Warning Plates	25	£19.39
BSHK033	Window Warning Stickers	100	£12.30

*This table is intended to provide an indication of the material quantities generally recommended. All projects are unique and should be surveyed to understand the requirement for additional connectors, jumpers etc not specified in this table. This is not intended as a quotation tool.

QUICK REFERENCE GUIDE		20 m	40 m	45 m	60 m	75 m	150 m	250 m	300 m	400 m	500 m
BSHK101	Avishock Track x 20 m	1	2	3	3	4	8	13	15	20	25
BSHK040	Small Energiser	1	1	1	1	1	1	2	2	3	4
BSHK120	Large Energiser							1	1	2	2
BSHK021	Straight/corner connectors x 25	1	1	1	1	1	1	1	1	1	2
BSHK022	Jumpers x 25										
BSHK112	Lead out wire x 20 m	1	1	1	1	1	1	1	1	1	1
BSHK023-100	Female spade connectors x 100	1	1	1	1	1	1	1	1	1	1
BBADH001	Avisil - 1 tube 10 m	2	3	5	6	8	15	25	30	40	50
BSHK031	Wire guides x 100	1	1	1	1	1	1	1	1	1	1
BSHK032	Warning plates x 25	1	1	1	1	1	2	2	3	4	4

BIRD MESH & PROOFING

WELD MESH FOR BIRDS

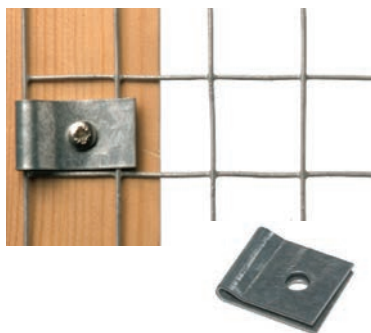

Galvanised welded wire square mesh is an ideal solution for preventing bird access. The benefit of using a welded square mesh is the range of wire thicknesses available, roll thickness or mesh panels sizes.

ORDER CODE	DESCRIPTION	PACK SIZE	PRICE
BMIS073	Pigeon/Starling Weld Mesh	6 m	£36.00
BMIS072	Pigeon/Starling 25 mm x 25 mm	30 m	£170.62
BMIS088	Pigeon 50 mm x 50 mm	25 m	£272.28
BMIS075	Sparrow 25 mm x 12.5 mm	6 m	£33.13
BNET057	Weld Mesh Clips, 5 mm hole	50	£26.87

SOLAR PANEL MESH & CLIPS



This innovative system is designed specifically to keep all creatures from getting under solar arrays, protecting the roof, wiring and equipment from their damage. This non-penetrating system is fast and easy to install, and can be removed for service. The Solar Mesh Clips are recommended every 18 inches. Tin Snips and other basic tools required for Installation.

ORDER CODE	DESCRIPTION	PACK SIZE	PRICE
BSLRMESH	50 ft x 8 inch Mesh	15 m	£110.31
BSLRCP10	Solar Clips	10	£25.91

CHIMNEY SPIKE

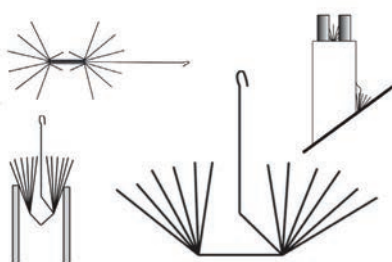

Heavy-duty spike designed to prevent seagulls from nesting in small areas on roofs. Made from 3 mm stainless steel rods, it can be bent in place to protect areas such as chimney pots, between the slope of a roof and the chimney stack. Recommended to be used in conjunction with Avipoint G20 Bird Spikes. Supplied flat packed.

ORDER CODE	DESCRIPTION	PACK SIZE	PRICE
BCHI001	Chimney Spike	Each	£11.93

CHIMNEY GUARD



The Chimney Guard is a device designed to keep birds from landing on chimney pots. Made from black painted mild steel, the Chimney Guard will fit most standard size chimney pots. For roof work, we also supply the Ladder Stopper that prevents a ladder from slipping on any surface and the Ladder Clamp that secures your ladder on the top of your vehicle for transportation.

ORDER CODE	DESCRIPTION	PACK SIZE	PRICE
BMIS125	Chimney Guard for Roofs & Chimneys	Each	£20.03

DADDI LONG LEGS

This system has a freely rotating head with long stainless steel wires that bounce in the wind or when birds contact it. This not only irritates the birds, but also interferes with their attempts to land or take off. The device can be screwed in place through the 3 mounting holes. If it is to be glued in place the Plastic Stick-on-Base (BDAD005) will be required.



ORDER CODE	DESCRIPTION	PACK SIZE	PRICE
BDAD001	1.25 m diameter Daddi Long Legs	Each	£60.21
BDAD002	2.5 m diameter Daddi Long Legs	Each	£78.03
BDAD005	DLL Plastic Stick-on-Base (inc. 3 screws)	Each	£5.50

PRICKLER STRIP

Mainly used on top of garden walls and fences to protect against cats. It has also been used successfully against light pressure pigeon infestations in areas where height is restricted and for short-term problems on window sills where crows are perching.



ORDER CODE	DESCRIPTION	PACK SIZE	PRICE
BMIS003	Prickler Strip (46 cm x 5 cm)	Each	£2.34

PIGEON TRAPS

All pigeon traps are flat packed and easy to assemble. When assembled, the dimensions are 1 m x 60 cm x 30 cm. Two sets of 'bob-wire' entrances are supplied as standard in all the traps. If required, these can be replaced with ground funnel entrances, available as an optional extra.

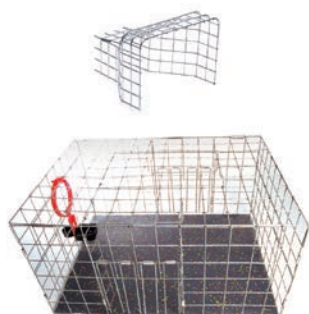

ORDER CODE	DESCRIPTION	PACK SIZE	PRICE
BTRA029	Feral Pigeon Trap with floor	Each	£108.21
BTRA050	'Foldaway' Feral Pigeon Trap no base	Each	£75.31
BTRA031	Ground Funnels	Pair	£22.94

SPARROW TRAPS

This is a rigid multi-catch trap with two one-way entrance tunnels leading to a trapping section. From here a further one-way entrance tunnel leads to the holding section. Dimensions: 62 cm x 35 cm x 22 cm



ORDER CODE	DESCRIPTION	PACK SIZE	PRICE
BTRA007	Sparrow Cage Trap	Each	£66.62

BIRD TRAPS & SCARING DEVICES

SPARROW TRAP DOOR



The Sparrow "Trap Door" was specifically designed to provide a discrete, gentle, hygienic, and cost-effective way to get small birds out from buildings. When set, the "Trap Door" is simply a welcoming platform with food. To increase the effectiveness of the trap, an audio module imitating a variety of sparrow calls is sold with this unit.

ORDER CODE	DESCRIPTION	PACK SIZE	PRICE
BPT7200	Sparrow Trap Door with Audio Module	Each	£252.97

HUMANE BIRD DISPATCHER



A special tool available to ensure that bird control is achieved in the correct, humane manner. Suitable for use in pest control, game bird management and poultry care. High quality British made product. An essential tool for the professional bird controller.

ORDER CODE	DESCRIPTION	PACK SIZE	PRICE
BMIS020	Semark Dispatcher	Each	£54.23

LASER STRIKE



Precision bird scaring laser - intended only as a bird scaring device for professional users - keep out of the reach of minors. The Laser Strike uses optical quality precision lenses and components and has been specifically developed for use as a safe, effective, silent, bird scaring tool which is ideal for agricultural use in built-up areas and buildings where loud noises are a problem to livestock and the general public.

ORDER CODE	DESCRIPTION	PACK SIZE	PRICE
BLASTRIK	Precision Bird Scaring Laser	Each	£372.71

TERROR KITE



Flies at twice the height of the pole. Exploits bird pests instinctive fear of hawks and is very effective and silent. No running costs. Hand made in England. Kit consists of: Terror-Kite + 6 Metre Pole (Includes Flying Line + Support Stake) Additional sizes also available please contact the office.

ORDER CODE	DESCRIPTION	PACK SIZE	PRICE
BHAWKK6M	Flying Terror Kite	Each	£116.51
BHAWKKNP	Terror Kite (kite only)	Each	£33.78

FLYING FALCON

These type of products are best used as part of a managed scaring strategy, in conjunction with other scaring or proofing products.



ORDER CODE	DESCRIPTION	PACK SIZE	PRICE
BMIS023	Flying Falcon	Each	£49.30

AN AWARD winning

COMBINATION



Charles Phillips
MBA M.Sc
COMMERCIAL
DIRECTOR



Charles has extensive experience in leading the development and integration of existing and new products into global markets as well as the strategic and tactical growth for brand expansion into new territories. In addition to his formal qualifications, he has specialist knowledge in biological control and insect attractants/ repellents and control with pheromones as well as the regulatory requirements of these active ingredients.

Paul Fisher
SALES &
COMMERCIAL
DIRECTOR



Paul has spent over 20 years of his pest control career in the service sector specialising in areas such as the Food & Beverage and Pharmaceutical sector as well developing his career into Corporate Account Management overseeing & supporting some of the most recognised brands throughout the UK and around the world. Having joined the BEH team Paul is keen to build on the strong customer-focused experience that BEH pride themselves whilst continuing to provide our customers with the good, honest product & technical support that they deserve.

Will Kirkpatrick
UK SALES
MANAGER



Will has over 16 years experience in the pest control industry. Will has worked much of his career in operational roles and holds RSPH Level 2 qualification. With extensive field knowledge Will is available for site visits and advice for those challenging pest issues that need additional support. For all practical advice, Will will be happy to provide his support by telephone or in-person.

Ellen Rogers
SENIOR
ACCOUNT
SALES MANAGER
& EXPORT



Ellen has been with Barretine for over 20 years and has excellent knowledge of the pest control industry. Ellen has shown this by passing the Lantra Rodent Control course, Wildlife Aware and IATA dangerous goods certification. Ellen is always willing to help with any technical query, quotations and advice with treatments.

Josh Randall
TECHNICAL
SALES MANAGER

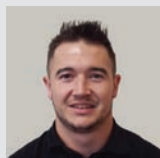

Josh has 9 years experience in the pest control industry. His qualifications include RSPH 2, a number of industry standard training certificates as well as an approved BASIS NSK. He is available for site visits and technical advice.

Carly Richards
ADMIN TEAM
LEADER
& TRAINING
CO-ORDINATOR

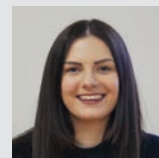

Carly has a great knowledge and understanding of the pest control industry. This has been demonstrated by passing numerous pest control courses including Lantra rodent, bird & insect control.

Carly has a customer service level 3 (NVQ) and is happy to help with any quotations, technical queries and advice regarding most aspects of pest control.



- FOGGERS
- SPRAYERS & ACCESSORIES
- DUSTERS
- BAIT GUN APPLICATORS
- DECANTING, MIXING & STORAGE
- TORCHES, TOOLS & LADDERS
- VOID INSPECTION CAMERAS
- MOTION CAMERAS
- TECHNICAL MANUALS

APPLICATION equipment

PRODUCTS 

PEST CONTROL CATALOGUE 2021

If you are unsure which insecticides can be applied through the various applicators, then please see our A-Z charts within the Technical Section to the rear of the catalogue.

DYNA-FOG HURRICANE



ULV/misting electric portable aerosol applicator, dispenses both OIL and WATER-BASED liquids. Adjustable output up to 19 litres/h. Available with tank float valve for continuous operation. Particle size: 5-50 microns (mmD). Tank capacity: 3.8 L. Weight: 3 Kg. Metering valve to control output and droplet size.

Each

ORDER CODE: BFUDYHU2

£593.38

B & G MODEL 2600 FOGGER (240V)



A robust plastic fogging machine with directional hose and flow adjustment knob. 110 volt option also available.

Each-18" Hose

ORDER CODE: BFOBG262

£371.56

Each-48" Hose

ORDER CODE: BFOBGR61

£397.53

DYNAFOG CYCLONE - ULV FLEX HOSE



18" flexible hose with adjustable nozzle. Suitable for hard-to-reach areas. Tank capacity: 3.8 L. Weight (empty): 4.8 Kg.

For similar unit with higher tank capacity see Dynafog Tornado.

Each

ORDER CODE: BFODYCFH

£1124.31

DYNAFOG TORNADO ULV



Multi-range adjustment allows flow range from 19 litre per hour down to ULV range. Ideal for humidity and pest control in warehouses/greenhouses etc. Tank capacity: 11.4 L. Weight (empty): 9.1 Kg.

Each

ORDER CODE: BFOTO240

£1186.77

FOGGERS

APPLICATION equipment PRODUCTS

DYNAFOG CYCLONE ULV



The Cyclone ULV Ultra-precision meters particles under 20 microns at any flow rate and viscosity. Ideal for pest control in Warehouses/greenhouses etc.
Tank Capacity: 3.8 L. Weight (empty): 4.25 Kg. 110 volt option available.

Each

ORDER CODE: BFODYCY2

£944.72

IGEBA NEBULO



Manufactured from strong durable resistant thermoplastics. Powerful electric motor producing greater aerosol volume, at higher velocity, with deeper penetration. More uniform droplet spectrum. Droplet size can be regulated by increasing or decreasing the solution flow.

Each-48" Hose

ORDER CODE: BFOINEBU

£585.45

IGEBA NEBUROTOR



Similar to the Nebulo but this unit can be set to rotate between 90 and 360 degrees. The Neburotor can also be fitted to the wall by means of a wall support.

Each

ORDER CODE: BFOINERO

£738.25

SS MINI FOGGER



Constructed of corrosion resistant materials and available in 110V and 240V, it is designed for jobs where a smaller and less expensive fogging machine is desirable.
User friendly. Use the rotary valve to adjust the output size, 15-40 microns, adjustable.

Each

ORDER CODE: BFOSSMIN

£278.34

FONTAN STARLET ULV FOGGER/LV



The Fontan Starlet ULV/LV cold fogger is portable and has a spray gun that has a trigger for intermittent fogging and a locking device for continuous operation. The Fontan Starlet can either be operated in the ULV (Ultra Low Volume) or in the LV (Low Volume) spraying mode. Perfect for treating buildings, outdoor waste sites and is especially suited for disinfection purposes.

Each	ORDER CODE: BFOFOSTA	£1,946.55
------	----------------------	-----------

SWINGFOG SN50



This machine is versatile, powerful and with a chemical auto cut off device, offers a choice of application methods. These products are made from top quality materials that will ensure many years of service, and all parts that come in contact with chemicals are made from stainless steel.

Each	ORDER CODE: BFOSWSN5	£1,998.77
------	----------------------	-----------

ULV APPLICATOR



A simple robust Ultra low volume applicator for use to apply Grain-Tect ULV and K-Obiol formulations to grain. Kit includes pump, nozzle, air and liquid transfer tubing pressure regulator.

Each	ORDER CODE: BULVAPLI	£POA
------	----------------------	------

We've made it
SUPER EASY

TO ORDER ONLINE

BarrettineEnv.co.uk



GLORIA STRATOS



Strong stable plastic container with integral filler funnel. Very efficient pump, comfortable to operate. Dial type container pressure gauge and brass relief valve. Sturdy trigger control valve with integral strainer to reduce blockages.

5 Litre	ORDER CODE: BSPGLST5	£88.13
---------	----------------------	--------

GLORIA 505T



The Gloria 5 litre stainless steel sprayer consists of a lined container that comes with a pressure gauge, safety relief valve, decompression valve and carrying strap. Other robust features include the brass trigger, brass pump & brass lances to ensure longevity of the unit.

5 Litre	ORDER CODE: BSPGLSS5	£283.51
---------	----------------------	---------

B & G ACCU SPRAYER



A metal compact sprayer that is handy for when it is not suitable to use a larger sprayer. Fitted with the usual high-standard B&G extenda-ban valve, and is supplied with a crack and crevice straw. Supplied with a carry pouch that attaches to your belt, and the valve clips to the pouch for added convenience. A measuring device for easy mixing is supplied. Capacity 473 ml.

473 ml	ORDER CODE: BACCUSPR	£127.20
--------	----------------------	---------

GLORIA 405T



The 405T 5 litre galvanised steel lined sprayer is an efficient and reliable sprayer for heavy-duty use.

5 Litre	ORDER CODE: BSPGL176	£230.56
---------	----------------------	---------

GLORIA 510T



The Gloria 10 litre stainless steel sprayer. Has the same specification as the 505T but a larger 10 litre capacity.

10 Litre

ORDER CODE: BSPGL142

£314.64

GLORIA 410T



The 410T 10 litre galvanised steel lined sprayer is an efficient and reliable sprayer for heavy-duty use.

10 Litre

ORDER CODE: BSPGL172

£256.32

CIFARELLI M1200 KNAPSACK



The Cifarelli M1200 Mistblower is ideal for pest control treatments, fumigation, horticulture and waste management. With the conversion kit (not supplied) granules can also be applied using the mist blower. This machine offers easy operator use, and maintenance. The 77 cc engine offers 105 m/sec airspeed.

17 Litre

ORDER CODE: BFOCIM12

£801.85

PROFISTAR SPRAYER



A universal 5 litre plastic compression sprayer with 4 bar operating pressure. Complete with 50 cm curved brass lance, adjustable brass nozzle, and viton seals making it ideal for pest control. Can be used with the XL8 extension.

Each

ORDER CODE: BSPBIPRO

£116.04

GLORIA PRESSURE REGULATORS



Adjustable Pressure Regulator allows you to set your sprayer to a constant spray pressure of between 1 - 6 bar, irrespective of higher pressures that maybe present in the sprayer pump or container.
Only recommended for use with non-corrosive, water-based chemicals.
Fixed pressure regulator offering pressures of 1.5 bar or 3 bar. Sold individually.

Adjustable	ORDER CODE: BSPGLPCV	£89.45
Fixed	ORDER CODE: BSPGLPRA	£42.49

SPARES FOR GLORIA 505, 405, 510 & 410



BRASS LANCE		
Each	ORDER CODE: BSPGLO5L	£16.94



HOSE ASSEMBLY		
Each	ORDER CODE: BSPGLO5H	£20.97



BRASS TRIGGER		
Each	ORDER CODE: BSPGLO5T	£41.96



GLORIA SEAL KIT		
Pack	ORDER CODE: BSPGSEAL	£15.14



CRACK/CREVICE NOZZLE		
Each	ORDER CODE: BSPGCCRN	£11.81



TELESCOPIC LANCE		
1 - 2m	ORDER CODE: BSPGLBTL	£48.04



GLORIA FLAT FAN NOZZLE ASSEMBLY		
Each	ORDER CODE: BSPGLO5N	£9.51



GLORIA REPLACEMENT PUMP		
Each	ORDER CODE: BSPGLREP	£95.41



GLORIA COIL HOSE		
Each	ORDER CODE: BSPGCOIL	£60.56

GLORIA SPARE PARTS

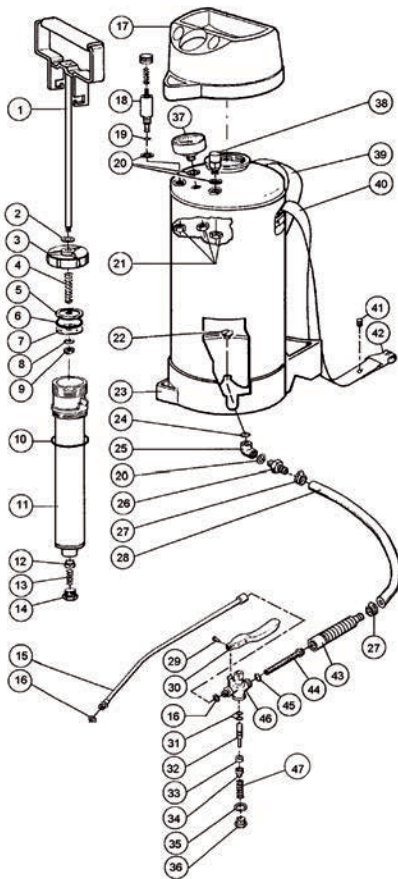

KEY	DESCRIPTION	PART No.	KEY	DESCRIPTION	PART No.
1	Piston rod with handle - bare	709150	29	Rivet for trigger lever	633070
2	Buffer washer for pump	611170	30	Lever for trigger valve	600680
3	Pump cap / piston guide	605843	31	O ring for trigger spindle	606571
4	Buffer spring for pump	610471	32	Valve spindle without O rings	607472
5	Piston plate - dished	624230	32	Valve spindle with O rings	711430
6	Piston O ring	625971	33	Rubber valve disc	602070
7	Piston plate - flat	624330	34	Housing for valve disc	602570
8	Locking washer	200110	35	Washer for base plug	602270
9	Hexagon nut for piston rod	634170	36	Base plug for trigger valve	602370
10	Pump sealing O ring	627070	37	Pressure gauge, nut & washer	706410
11	Pump barrel	711210	38	Relief valve with washer	706550
12	Footvalve poppet	701980	39	Strap c/w studs for 141T	620140
13	Spring for footvalve	615972	39	Strap for 176T - has no fittings	609834
14	Retaining plug for footvalve	605000	39	Strap142T/172RT not for hook	620130
15	Lance tube with washer	701310	40	Strap142T/172RT - for hook	604530
16	Washer for lance and trigger	617070	41	Stud for carrying strap	603060
17	Black filler funnel 10 litre	604240	42	Hook for carrying strap	604410
17	Blue filler funnel 10 litre	604250	43	Filter barrel for trigger	511760
17	Blue filler funnel 5 litre	604270	44	Strainer for trigger valve	613320
17	Black filler funnel 5 litre	604280	45	O ring for filter barrel	512670
18	Decompression valve c/washer	709080	46	Body for trigger valve	511820
19	O Ring for decomp'n valve	213440	47	Spring for trigger valve	612071
20	Washer for gauge	618170	48	Black plastic base 141T	604420
21	Hexagon nut for gauge	604500	48	Black plastic base 142T	604430
22	Screw for container outlet	538683	49	Brass nut for nozzle holder	00-400
23	Blue plastic base for 176T	538726	50	Nozzle tip - please specify	Various
23	Blue plastic base for 172RT	538725	51	Nozzle sealing washer	00-349
24	O ring seal for outlet elbow	130090	52	Nozzle strainer 100 mesh	02-028
25	Outlet adaptor elbow	538682	53	Strainer 50 mesh blue P/P	02-416/50
26	Tank outlet adaptor w/o washer	602800	54	Brass body for nozzle holder	00-402
26	Tank outlet adaptor c/w washer	712650	55	Cap for adjustable nozzle	601900
27	Worm drive hose clip	602900	56	O ring for adjustable nozzle	601910
28	Hose 1.3 metres c/w clips	706950	57	Body of adjustable nozzle	601920

SEAL KITS, REPAIR KITS & ASSEMBLIES

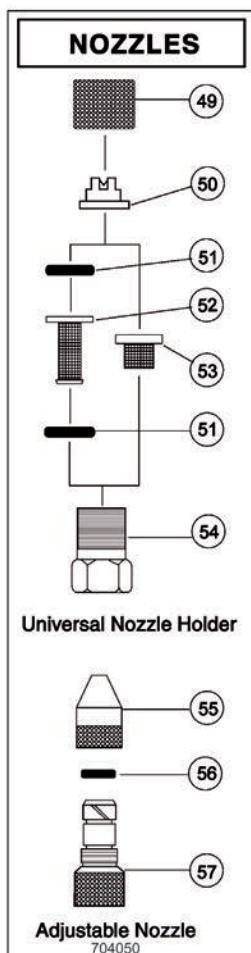

DESCRIPTION	PART No.	KEY NUMBERS INCLUDED IN ITEM
Complete Seal Kit	707270	6, 10, 12, 16, 19, 20, 31, 33, 35, 45, 51, 56.

PUMP GROUP		
DESCRIPTION	PART No.	KEY NUMBERS INCLUDED IN ITEM
Piston rod assembly complete	710260	1, 2, 3, 4, 5, 6, 7, 8, 9.
Piston end components	706490	5, 6, 7, 8, 9.
Pump barrel with footvalve	712410	10, 11, 12, 13, 14.
Footvalve components	725790	12, 13, 14.
Pump assembly complete	710240	1, 2, 3, 4, 5, 6, 7, 8, 9, 10, 11, 12, 13, 14.

TRIGGER VALVE & HOSE GROUP		
DESCRIPTION	PART No.	KEY NUMBERS INCLUDED IN ITEM
Seal kit for trigger valve	706560	16, 31, 33, 35, 45.
Pack of 10 x 617070 washers	706870	16.
Trigger Valve complete	707340	16, 27, 29, 30, 31, 32, 33, 34, 35, 36, 43, 44, 45, 46, 47.
Trigger Valve repair kit	711600	31, 32, 33, 34, 47.
Hose complete with ends	00-605	20, 26, 27, 28, 43.

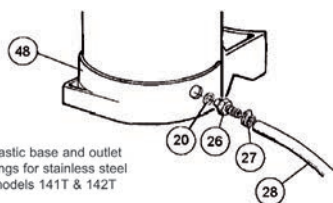

Plastic base and outlet fittings for stainless steel models 141T & 142T

SPRAY LANCE		
DESCRIPTION	PART No.	KEY NUMBERS INCLUDED IN ITEM
Lance tube with washer	701310	15, 16.

FLEXIBLE EXTENSIONS FOR AEROSOLS

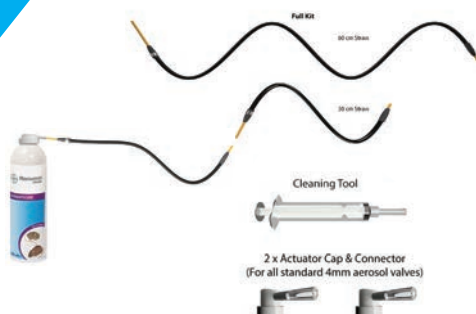

Flexible extension straws for Racumin Foam and other aerosol sprays such as Bayer Crawling & Bayer Flying. The straws come supplied in a multi-pack containing: 1 x 60cm flexible straw, 1 x 30cm flexible straw, 1 x cleaning tool, 1 x actuator cap & connector (fits all common 4mm male aerosol valves) and 1 x additional spare actuator cap.

Each	ORDER CODE: BFLESTKI	£21.32
------	----------------------	--------

STANDARD PA2 POWDER APPLICATOR KIT

The PA2 is an efficient, effective and simple to use powder applicator. Fast and easy to use - you can treat more nests in less time. Reduced preparation time, no pumping required - just insert the CO2 cartridge, and it's pressurised ready to use. Extremely light and self-contained - no requirement to recycle gas cylinders. Powerful gas cartridge propels the powder 4.5 + metres using aluminium lances. If you already possess the lances, purchase the PA2 on its own.



PA2 Standard Kit		
Each	ORDER CODE: BSPAZSPR	£400.63
CO ₂ Cartridges - PA2		
50	ORDER CODE: BAGCO2CA	£46.29

PRO PA2 POWDER APPLICATOR KIT

The Professional Kit is a patented, fully upgraded PA2 for those that require a complete ready-to-use package. The pack is supplied with 2 x 1.5 m lances & 24 CO2 cartridges. Time is money, and this powder applicator is fast and easy to use, you can treat more nests in less time. Extremely light and self contained, no requirement to recycle gas cylinders. Powerful gas cartridge propels the powder 4.5 + metres using GPS lances.



Professional PA2 Applicator Kit		
Each	ORDER CODE: BSPA2SPR	£460.56
CO ₂ Cartridges - PA2		
50	ORDER CODE: BAGCO2CA	£46.29
0.7 m Aluminium Lance		
Each	ORDER CODE: BDR5EL70	£47.56
1.5 m Aluminium Lance		
Each	ORDER CODE: BDR5EL15	£50.97

HAND SPRAYERS

APPLICATION equipment

PRODUCTS

SPRAY MATIC 1.25P HAND SPRAYER



A quality 1.25 litre hand held sprayer with manual pump. Operating pressure of 2 bar. It comes with Viton seals and adjustable nozzle with swivelling nozzle head.

Each	ORDER CODE: BSPMA125	£28.45
26 cm Extension	ORDER CODE: BSPMEX26	£9.59

GLORIA 89 SPRAYER



Oil-resistant plastic sprayer. Features include knuckle type nozzle holder that can be angled and swivelled. Also fitted with a variable spray nozzle.

1 Litre	ORDER CODE: BSPGLPL1	£54.42
---------	----------------------	--------

LASER 1 VITON



Complete with Pin-to-cone nozzle. This sprayer has a capacity of just over 1 litre and is great for small chemical applications and spot spraying where the convenience of one-hand operation is desirable. Translucent white tank allows fluid levels to be seen. Steel pump rod is plated for smooth operation.

Each	ORDER CODE: BSPBVITO	£33.96
------	----------------------	--------

MINT
EXCLUSIVE MEMBERSHIP



Join our exclusive
Mint Membership
it's 100% free.

Register today online or contact our sales office
Email: beh@barrettine.co.uk
www.barrettineEnv.co.uk

BIRCHMEIER RPD 15 SPRAYER



The backpack sprayer has a new designed external pump which is integrated directly into the RPD's 15 pump lever. The results is an easy to use and quick to clean sprayer. The new hose positioning is also a lot handier. Also includes a non-drip piston pump. Can be used with the XL8 extension.

10 Litre

ORDER CODE: BSPBIRPD

£154.51

BIRCHMEIER REC ELECTRIC KNAPSACK



Battery-operated backpack sprayer with completely new concept of controlling the pressure by electronics providing options for the user. You operate pressure at the nozzle, which is adjusted with an application controller. Complete with 0.5-6 bar pressure for an optimised spray pattern. Can be used with the XL8 extension.

Each

ORDER CODE: BSPBIREC

£652.03

XL8 EXTENSION



The XL8 8 metre extension lance is a lightweight telescopic extension lance that extends from 1.5 m to 8 m, allowing easier treatment of hard to reach areas. The end of the extension lance has a flexible hi-viz tip allowing the operator to bend it to the required angle and easily see the tip. The extra reach eliminates the need for costly access equipment. The extension lance stores into a 1.3 m long protective case and has an overall weight of 1.5 Kg.

Each

ORDER CODE: BDR5EX8M

£272.18

Spray nozzle extension

ORDER CODE: BDR5EX8N

£26.07

MINI FLEX EXTENSION



The 50 cm Mini Flex Extension can be manoeuvred into various angles for ease of application. Can be used with Birchmeier sprayers and dusters by connecting to the trigger or lance.

Each

ORDER CODE: BDR5MFEX

£38.37

DUSTERS

APPLICATION equipment

PRODUCTS

APPLICATION EQUIPMENT - DUSTERS

DR5 PROFESSIONAL POWDER DUSTER



A 5 litre tank that holds approximately 3-4 Kg of insecticide powder/dust. It works at a maximum operating pressure of three bar. Other features include pressure relief valve and air valve.

Each

ORDER CODE: BSPBIDU5

£112.50

DR5 SUPPORT BRACKET & HANDLE

For use with DR5 lances to provide additional stability.

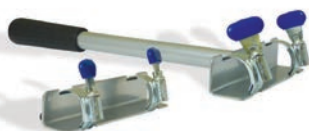

Bracket - Each

ORDER CODE: BDR5SUBR

£14.29

Handle - Each

ORDER CODE: BDR5SUHA

£32.29

DR5 ALUMINIUM RIGID LANCES



Can be used with dusts and liquids, can also be used with Gloria sprayers.

1 x 700 mm

ORDER CODE: BDR5EL70

£47.56

1 x 1.5 m

ORDER CODE: BDR5EL15

£50.97

DR5 1-2 METER TELESCOPIC LANCE



Aluminium lance is sent out complete with a 1/4 inch brass nut to allow connection to existing applicator (included in cost).

Each

ORDER CODE: BSPDU5EX

£59.53

DR5 1 METER STANDARD LANCE



Each

ORDER CODE: BSPD5EXT

£20.35

LANCE CARRYING TUBE

A sturdy 5 ft, rigid plastic tube ideal for the safe carriage of applicator lances. Wide enough to hold at least six lances.



Each

ORDER CODE: BLANTUBE

£11.75

DR5 SPARE PARTS

Replacement parts can be purchased from the list below. Please check you have the item against the diagram below.

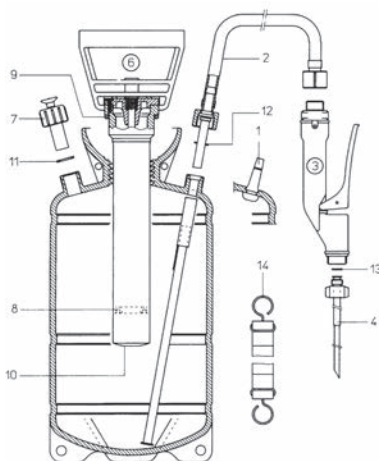

PRODUCT	ORDER CODE	PRICE
DR5 Professional Powder Duster	BSPBIDU5	£112.50
DR 5 Injector needle, curved	BSPD5INJ	£12.90
1. Valve	BSPD5VAL	£7.08
2. Hose assembly	BSPD5HOS	£24.56
3. Pistol valve assembly	BSPD5TRI	£22.17
4. Powder tube	BSPD5BRW	£14.12
5. Nipple wand connector	BSPD5NWC	£4.30
6. Pump assembly	BSPD5PUM	£29.32
7. Safety valve, 3 bar	BSPD5PRV	£10.92
8. Sleeve	BSPD5PSL	£10.90
13. Gasket 11,9/7 x 1,5 (Viton) Qty. 12 per pack	BSPD5TRG	£16.50
14. Carrying belt	BSPD5STR	£9.10
14a. Gasket set	BSPD5GAS	£15.68

DUSTERS

APPLICATION equipment

PRODUCTS

THE DUSTICK

Ideal tool for target dusting from over 20 ft away. The durable, heavy-duty brass pump provides superior pressure. The four lightweight aluminium extensions can be assembled and dismantled in seconds. Heavy-duty carrying bag is also included. Full range of Duststick spares in stock.



Each

ORDER CODE: BSPDSTIC

£227.87

DUSTSTICK SPARE PARTS



PRODUCT	ORDER CODE	PRICE
1: Zipper Bag	BSPDU001	£44.75
2: Aluminium Poles	BSPDSPOL	£17.33
3: Aluminium Poles with button	BSPDSPOB	£20.69
4: Dust Canister	BSPDU003	£78.31
5: Brass Pump	BSPDU004	£43.02
6: Pump Connection Adaptor	BSPDU005	£29.11
7: Dust Canister Nozzle	BSPDU007	£7.17
8: Dust Canister Adaptor	BSPDUADA	£18.00
9: Rubber Stopper	BSPDU008	£8.62
10: Pump Repair Kit	BSPDU009	£12.19
11: Pump O'Ring	BSPDU010	£3.89
12: Pump Knob	BSPDU012	£7.08
13: Nozzle Cap	BSPDU013	£1.25
14: Aluminium Pole O'Ring	BSPDU014	£1.42
15: Rubber Grip	BSPDU015	£7.17
16: Nozzle Set	BSPDUNOZ	£29.39

B & G 2250 ELECTRIC DUSTER



An electric dust/granular applicator, ideal for applying large volumes of materials consistently over a large area. 110v or 240v.

Each	ORDER CODE: BSPBGEDU	£368.73
Replacement 48" Hose	ORDER CODE: BSPBGEHO	£66.82

B & G BULB DUSTER



This small duster fits any service kit. The bulb is made of natural rubber for maximum flexibility and long life along with featuring a "No Gasket" seal. The plastic extension tubes provide safe crack-and-crevice application around electrical outlets, and one extension can be used as a siphon tube in the bulb when applying granules. Variety of different extension kits are available.

Each	ORDER CODE: BGBULBDU	£21.49
------	----------------------	--------

MINI DUST-R



Ideal back-up tool. Holds 227 grams of dust and comes with a range of extensions and dispersal tips (stored in the handle).

Each	ORDER CODE: BSPMINDU	£66.94
------	----------------------	--------

Save time, place
your order any time.

PAY ONLINE

BarrettineEnv.co.uk



USER
FRIENDLY



EASY TO
SIGN UP



LATEST PRODUCTS
& PROMOTIONS



BAIT GUN APPLICATORS

APPLICATION equipment

PRODUCTS

B & G MULTI DOSE GUN



The Multi-Dose Gun allows you to precisely place gels. One pull gives you the same dose each time. Instant selection from six different gel and paste sizes. Placement sizes specifically designed for roach & ant control. No need to calibrate- just select the size and pull.

Each	ORDER CODE: BBGMULDO	£56.53
------	----------------------	--------

SPX PLASTIC BAIT GUN



A high quality, light weight, cost effective plastic bait gun. Gun provides pressure relief at end of stroke to control run-on.

Each	ORDER CODE: BBGSPXPL	£13.93
------	----------------------	--------

EFD BAIT GUN



An accurate bait dosing gun comes with moulded plastic carry case and spare tips. (torch attachment not included).

Kit	ORDER CODE: BBGUNKIT	£141.11
Funnel Tips x25	ORDER CODE: BBGUNFUT	£15.12
Longreach Tips x10	ORDER CODE: BBGUNLRT	£27.51
Longshot Ext. Tip	ORDER CODE: BBGUNLSX	£20.11
S/Steel Tips x25	ORDER CODE: BBGUNSST	£12.95
Holster	ORDER CODE: BBGUNHOL	£54.92

TORCH & ATTACHMENT CLIP

For use with the EFD bait gun.



Each

ORDER CODE: BBGMIMAG

£66.48

HEAVY-DUTY CAULKING GUN

This heavy-duty caulking gun is suitable for 310 ml cartridges with a length of up to 220 mm. The handle has a built in caulking tube cutter so no additional cutting tools are required, just simply insert the tip between the blade and squeeze the handle. A tip piercer/cleaner also features to clear dried product from the end nozzle or tip.



Each

ORDER CODE: BBGHDCAU

£16.01

TECHNICIANS FIELD GUIDE

A complete and essential guide for the professional.

The Barrettine's pocket-size A6 Pest Technicians guide contains detailed information to assist in the daily routine of a Professional Pest Control Operator: A 'how to' guide covering topics of insect and rodent information and identification, equipment calibration, non-chemical insect control measures, pesticide application and product safety, dealing with waste: Triple rinsing as well as detailed information on LD₅₀.

PRICE: £23.03
ORDER CODE: BPIDBOOK



FLYING
INSECTS

CRAWLING
INSECTS

SPI, AGRICULTURE
& AMENITY PESTS

RODENT
PESTS

BIRD
PESTS

EMPTY TUBS

Useful container for decanting rodenticides or relocating spent bait.



3 Kg (5.7 Litre)

ORDER CODE: BMTTUB57

£4.04

10 Kg (16 Litre)

ORDER CODE: BMTTUB16

£4.42

25 LITRE UN APPROVED CONTAINER

Diluting container for storing of pesticide rinsings/washings etc.



Decanter Tap

Turn your 25 litre container into an easy to dispense field water source with this quality fitted tap. Allows easy decanting of fluids into sprayers etc.

25 L Container

ORDER CODE: BMTPU025

£6.79

Decanter Tap

ORDER CODE: BMTTAP61

£5.16

CURTEC PESTICIDE STORAGE JARS

These jars also fit into our pesticide carry bags.



Each

ORDER CODE: BPESTJAR

£3.78

1 LITRE PLASTIC MEASURING JUG & FUNNEL

Capacity: 1 litre

Perfect for measuring liquids. Includes several different measurements, including millilitres and litres. Robust plastic design means it's easy to keep clean.

Funnel to help easy decanting of liquids.



1 L Jug

ORDER CODE: BAJUG1LT

£3.13

18 cm Funnel

ORDER CODE: BAFUNNEL

£7.61

PLASTIC MEASURING SCOOPS

This small green plastic scoop is ideal for use in decanting rodenticide etc. It is UK manufactured and is narrow and deep. There is a hole in the handle allowing the scoop to be hung up.



0.5 Litre	ORDER CODE: BASCOSMA	£3.32
1.5 Litre	ORDER CODE: BASCOLRG	£8.64

205 LITRE UN APPROVED CLIP TOP DRUM

205 litre UN approved clip top drum. Ideal for the safe storage of waste etc.



Each	ORDER CODE: BWADR205	£56.22
------	----------------------	--------

LARGE BAITING SPOON

A large baiting spoon allows you to accurately and securely place bait into burrows. 'Standard' length on the large spoon is 14".



Each	ORDER CODE: BBASPO16	£7.39
------	----------------------	-------

FIXX-IT TAPE

FIXX-IT is the ultimate repair tape, it requires no adhesive and is self fusing stopping leaks instantly (Water board approved WRAS). It holds up to 600 psi, insulates up to 8000 V, will not melt at temperatures up to 260 oC and not freeze at -50 oC. It has a wide chemical resistance meaning it can also repair oil and fuel lines. Can be used in the workshop, plumbing, automotive or outdoors.



Each (3 m roll)	ORDER CODE: BFIXX003	£4.08
-----------------	----------------------	-------

MINI MAGLITE AA



The small pocket size Maglite torch. Requires 2 x AA size batteries. Blister pack includes batteries and spare bulb.

Each

ORDER CODE: BTMINMAA

£19.72

MAG CHARGER SYSTEM



A highly engineered lighting tool. Complete with rechargeable (1,000 x) battery pack plus adaptors for both the office & the car. State of the art electroformed reflector, incredibly bright high-intensity halogen lamp and solid-state electronics throughout.

Each

ORDER CODE: BTMAGCHA

£147.43

MAGLITE 3D CELL TORCH



This torch requires 3 x LR20 batteries. Unit conforms to the same standard as the Mag Charger system.

Each

ORDER CODE: BTMAG3DC

£35.88

Spare Bulb

ORDER CODE: BTMAG3BT

£5.09

ULTRAVIOLET FOCUSING LED TORCH



This 395nm LED UV torch delivers fantastic performance of 20,000 hours for a lifetime of owner satisfaction. The aircraft aluminium construction torch will give up to 8 hours burn time from one set of batteries. The torch also has a spot to flood focus feature. Constructed of tough aluminium it is designed to give a reliable and long service life. Comes with a tube extender so that you can use either 3 x AAA alkaline batteries or 1 x 18650 Li-ion battery. Ideal for fluorescent tracking.

Each

ORDER CODE: BUVTORCH

£45.46

ULTRAVIOLET TRACKER TORCH

Ideal for use with tracking dusts, non toxic fluorescent baits as well as fluorescent rodenticides.



Each

ORDER CODE: BUVTLAMP

£22.47

P2-2 ALUMINIUM PEN TORCH

A 275 lumens white CREE LED Focus Control torch also known as the police tactical torch due to its brightness, size and durability. It is dust and waterproof IP66, 2 light mode settings, flawless smooth reflector for long distance beam. Up to 15 hours run time and 9 m range. Battery type: 2 x AAA size Duracell Alkaline Batteries (Included). Pocket clip attachment included.



Each

ORDER CODE: BTOUPT-2

£22.63

PS-IL10R INSPECTION LIGHT

The ultimate high-powered rechargeable inspection light, delivering an impressive 1000 lumen output, from the latest SMD LED technology. It has superior portability in the form of its integral hanging hook, foldable kick stand and strong magnet which all allow for easy hands free use. The PS-IL10R's battery life stands at 3-32 hours runtime. BATTERY: 3.7 5000 mAh Li-ion rechargeable battery WEIGHT: 338 g with Battery. DIMENSION: 205 x 60 x 42 mm



Each

ORDER CODE: BTOUIL10R

£62.46

MINT MAGNETIC TORCH

The perfect tool for any need, this double magnetic LED work light is great for attaching to any metal surface for optimal lightning. This aluminium flashlight allows you to extend from its normal size of 17cm to 58cm allowing you to pick up items that are stuck in hard to see and reach places with the magnet on front. This flashlight is equipped with three LED for extra bright exposure in dark spaces. When the light is extended the head becomes flexible and can be adjusted in any direction. Includes batteries for direct use.



Each

ORDER CODE: BPROMO

£15.10

REPLACEMENT BATTERIES

Replacement battery for use with lantern style torches.



AA Batteries x10	ORDER CODE: BTOBATAA	£5.91
AAA Batteries x10	ORDER CODE: BTOBAAAA	£5.91

MAGNETIC PICK-UP & MIRROR SET

The perfect tool for pest control inspections. This two piece set comes with a magnetic pick-up tool that has a 6 section extension and a mirror with 5 section extension. The mirrored end is mounted on twin ball joints for maximum rotation. The magnet has an LED to illuminate dark areas.



Each	ORDER CODE: BMAGTELP	£18.08
------	----------------------	--------

FLEXIBLE PICK-UP CLAW

This two piece flexible pick-up tool set is lightweight and ideal for reaching items in hard to reach places. One complete with a pick-up claw to grab items and the other complete with a magnetic head for metal detectable items. A great tool for any pest controller.



Each	ORDER CODE: BCLATELP	£10.95
------	----------------------	--------

DEWALT CORDLESS COMBI DRILL*



DeWalt 18V 2.0AH Li-Ion XR Brushless Cordless Combi Drill. Compact and ergonomic combi drill with 18V brushless motor and XR technology. Features include 65mm max torque, intelligent trigger design and spindle lock for a quick and easy bit change—ideal for consistent screw driving into a variety of materials with different screw sizes.

- 2 x 2.0Ah Li-Ion Batteries • 90min Charge Time • Max. Torque: 65Nm
- 15 Torque Settings + Drill + Hammer Drill • 13mm Keyless Chuck
- 2-Speed Variable & Reverse • All-Metal Gearing • Brake
- LED Work Light • Spindle Lock

*Models may vary.

Each	ORDER CODE: BDRIL18V	£147.69
------	----------------------	---------

HANDHELD VACUUM CLEANER WET/DRY



This cordless vacuum cleaner is ideal for quick clearing up of spillages of both solid products and liquids. The removable collection chamber allows the vacuum to be easily emptied ready for next use. Comes complete with detail brush, squeegee brush, storage bag and reusable filter.

Each

ORDER CODE: BVACUWDC

£49.14

TELESCOPIC TELESTEPS



A brilliant quality design. The ladder extends from just 90 cm to 3.8 m. Lightweight aluminium construction weighs just 9 Kg but allows a safe working load of 150 Kg. The ladder conforms to EN 131. Additional carriage charges may apply.

Each

ORDER CODE: BTELESTP

£201.10

UNIVERSAL FOLDING LADDER 4x3



Described as 'the most versatile ladder in the world'. This ladder can fold into different working positions and can be used as a single ladder, step ladder, work platform etc. Comes complete with platform boards and splayed base. In addition it folds down easily to fit into the back of a van or car boot. Made from titanium anodised aluminium (EN131 European standard). Additional carriage charges may apply.

Each

ORDER CODE: BUNA43EP

£175.71

LADDER CLAMP



Safely and securely allows you to transport your ladders on your vehicles roof rack whilst travelling.

Pair

ORDER CODE: BLADCLAM

£27.58

VOID INSPECTION CAMERAS

APPLICATION equipment

PRODUCTS

NEW

FERRET PRO - WIRELESS INSPECTION CAMERA



The Ferret Pro is a professional and durable next generation inspection tool designed and engineered with award-winning features to provide easier, faster & safer close up visual inspections. Includes App controlled variable focus lens, super-fast charge, Ferret always up viewing mode and right angle adaptor.

If you need to locate pest activity inside enclosed spaces or inspect wasps nests at a safe distance, then the Ferret Pro is the perfect tool for the professional pest controller.

Designed & engineered by Ferret Tools.



Turn your phone into a smart tool

Each

ORDER CODE: BFERRETP

£140.57

NEW

FERRET PRO STICK



The Ferret Stick is an extendable rod made of a tough rust resistant lightweight 201-grade stainless-steel frame and non-slip rubber handle with a secure wrist strap. It expands from 12" out to 55" and has a D° -20UNC thread, which is compatible with all Ferret products and accessories.

Note: Do not use the Ferret Stick near live power.



Each

ORDER CODE: BFERSTIC

£20.00

NEW

FERRET PRO WRISTBAND



The Ferret Wristband is the perfect companion to use with the Ferret Pro Wireless Inspection Camera. Securely attach any smartphone from 3.5" to 6" to your wrist so you can manoeuvre and operate the Ferret Pro freely. With a 360° rotatable front section, the phone can easily be turned to the perfect angle to capture important customer images & video footage.



Perfect companion for
your Ferret camera

Each

ORDER CODE: BFERWRIS

£20.00

RIDGID SEESNAKE INSPECTION CAMERA CA-25

The Ridgid® SeeSnake micro CA-25 is a compact handheld inspection camera with a fixed 17 mm waterproof imager head for basic and short-range inspection jobs. The micro CA-25 features a 17 mm aluminium imager head with 4 ultra-bright LED lights, bringing superior image quality to its 2.4" Colour LCD Screen. It also features Video Out for transferring live images to external devices and 180° Digital Image Rotation for getting upright images. Included with the micro CA-25 in a hard shell plastic case are a hook, magnet, mirror and RCA cable.

Note: No extension is available with this model.



Each

ORDER CODE: BSEESM25

£159.28



INSPECT WITH A FERRET FOR THE PROFESSIONAL PEST CONTROLLER



FERRET PRO

Multipurpose Wireless Inspection Camera

The Ferret Pro is a professional and durable next generation inspection tool designed and engineered with award-winning features to provide easier, faster & safer close up visual inspections.

The Ferret helps to quickly & easily locate pest activity inside enclosed spaces and inspect safely from a distance. It includes app controlled variable focus lens, super fast charge, Ferret always up viewing mode and right angle adaptor.

- ✓ Quickly identify the root cause of pest infestations in hard to access spaces
- ✓ Safely inspect wasp nests from a distance
- ✓ Avoid timely and unnecessary call-outs and follow-ups
- ✓ Save and share images and footage with your customers
- ✓ Inspect from the ground (no need to bring in a ladder) using the Ferret Stick for extended reach

TURN YOUR PHONE INTO A SMART TOOL



Authorised
Channel Partner

Barrettine
Environmental Health

TRAIL WILDLIFE CAMERA

High-Performance Photo and Video. This Game camera captures 16MP crystal clear images and video with super clear sound recording each time motion is detected of wild game. Integral PIR camera triggers 6MP or 1080P videos. Day and Invisible Infrared night vision up to 20 m and completely portable. IP66 WATERPROOF, dust-proof, drop-proof, and rain-proof. Use lithium AA batteries for best results. Records directly to SD card (up to 32 Gb - Not included).



Each

ORDER CODE: BMOTSCAM

£69.23

YI COMPACT DASH CAM

1080P Ultra HD - Records bright images in 1080p at 30 frames per second, delivers full HD images across three lanes. 2.7" Wide Screen. The integrated 2.7" LCD screen provides a real-time preview without being obstructive, navigation is easy-to-use. Superb Night Vision - Excellent night recording capabilities provide clarity and safety even at night. Captures vivid images and delivers accurate colours even in low-light environments. YI Dash Cam App - Built-in Wi-Fi lets you connect to the smartphone app to share videos.



Each

ORDER CODE: BDASHCAM

£62.14

Micro SD Card
(64GB)

ORDER CODE: BMICROSD

£24.09

TECHNICIANS FIELD GUIDE



The Barretline's pocket-size A6 Pest Technicians guide contains detailed information to assist in the daily routine of a Professional Pest Control Operator: A 'how to' guide covering topics of insect and rodent information and identification, equipment calibration, non-chemical insect control measures, pesticide application and product safety, dealing with waste: Triple rinsing as well as detailed information on LD₅₀. A complete and essential guide for the professional.

Each

ORDER CODE: BPIDBOOK

£23.03

THE BPCA PEST MANUAL



The aims of the manual are to provide the basic knowledge required by pest control technicians to carry out pest control operations competently, safely and with proper regard for the environment and the requirements of legislation. As well as having sufficient information to meet most of the requirements of the syllabus of the RSPH exam it's an ideal reference tool.

Each

ORDER CODE: BADASMAN

£129.85

ACHETA MITE HANDBOOK

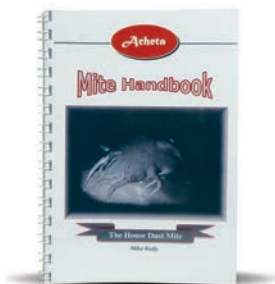

An excellent technical guide to this common but often missed or misidentified pest.

Each

ORDER CODE: BACHMITE

£39.90

ACHETA INDOOR PESTS HANDBOOK

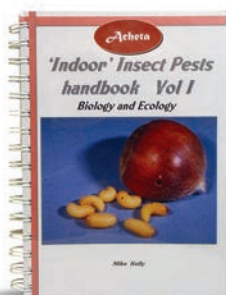

A must for anyone coming against insect pests on a regular basis. This fantastic handbook covers food storage and public health insects including clear identification guides.

Each

ORDER CODE: BACHININ

£51.41



- PROTECTIVE CLOTHING
- MASKS & FILTERS
- DISPOSABLE RESPIRATORS
- BEE & WASP PROTECTION
- VISORS & GOGGLES
- CARRY CASES & BAGS
- CHEMICAL SPILLAGE KITS & FIRST AID
- WARNING SIGNS & LABELS
- HYGIENE, DISINFECTANTS & CLEANING
- TORCHES, TOOLS & LADDERS

PPE & safety

PRODUCTS 

PEST CONTROL CATALOGUE 2021

PROTECTIVE COVERALLS

TYVEK PROTEC CLASSIC



Chemical and dust resistant, hooded with sewn seams, elasticated waist, arms & legs. Type 5 & 6 131N non woven high density polyethylene.

Medium	ORDER CODE: BPCTYCLM	£POA
Large	ORDER CODE: BPCTYCLL	£POA
X Large	ORDER CODE: BPCTYCXL	£POA

TYVEK CLASSIC & HOODED OVERALL



Category 3 Type 4, Type 5, Type 6 Conforms to EN 14126, Type 4B, EN 1073-2 and EN1149-5. Protection against particulate radioactive contamination. Does not contain halogen compounds so is easy to dispose of. Suitable for use in cleanroom applications. Self-adhesive zipper flap with integrated chin flap. Stretch thumb loop at end of sleeve.

Medium	ORDER CODE: BTYVEPLM	£POA
Large	ORDER CODE: BTYVEPLL	£POA
X Large	ORDER CODE: BTYVEPLX	£POA

3M™ COVERALLS TYPE 5/6



Designed to offer protection against hazardous dusts and limited liquid splash. Standards/ Approvals:
EN 1149-5 - Anti-static coating, EN 1073-2 Particulate Radioactive Contamination,
EN 13034:2005+A1:2009 Type 6 Liquid Splash, EN ISO 13982-1:2004 Type 5 Hazardous Dusts.

Medium	ORDER CODE: BPCBUDME	£POA
Large	ORDER CODE: BPCBUDLG	£POA
X Large	ORDER CODE: BPCBUDXL	£POA

POLY COTTON COVERALLS



General full length washable coveralls. Various colours & sizes available, please ask at the time of ordering. Add your company logo/name for a small extra charge.

Medium	ORDER CODE: BPCOTTME	£21.08
Large	ORDER CODE: BPCOTTCV	£21.08
X Large	ORDER CODE: BPCOTTXL	£21.08
Logo Charge	ORDER CODE: BEMBCHRG	£13.20

TYVEK OVERBOOTS

Strong and light Tyvek overboots for single use. Chemical and dust resistant.



1 x 10 Pairs

ORDER CODE: BPCOVBOO

£POA

TYVEK OVERSHOES

Disposable overshoes are manufactured from a strong and durable non-woven fabric. Ideal and professional way to help prevent transferring dirt and mud from outside to in.



1 x 100

ORDER CODE: BOVSHBLU

£POA

ULTRA NITRILE 487 GLOVES

A 32 cm Gauntlet, lined in sizes of 8.5, 9.5 and 10.5. Liquid proof glove, mechanical risks 3101. EN388 & EN374. Standard outer 10 pairs.



BUY 8 GET 2 FREE
20% OFF

Each - 8.5

ORDER CODE: BG4878.5

£POA

Each - 9.5

ORDER CODE: BG4879.5

£POA

Each - 10.5

ORDER CODE: BG48710

£POA

DISPOSABLE NITRILE GLOVES

A 100 % nitrile glove giving good level protection against minor nicks, cuts and abrasions. Slightly longer for improved protection. Standard outer 50 pairs. Priced per box.



Medium

ORDER CODE: BGTNTMED

£POA

Large

ORDER CODE: BGTNTRLG

£POA

X Large

ORDER CODE: BGTNTEXL

£POA

PROTECTIVE GLOVES

RED PVC GAUNTLET GLOVES



A 35 cm PVC gauntlet. One size fits all, lined general purpose glove. Liquid proof chemical glove, mechanical risks 4121.

Pair

ORDER CODE: BGRPVC14

£POA

RED PVC KNITWRIST GLOVES



One size fits all, lined general purpose glove. Mechanical risks 4111.

Pair

ORDER CODE: BGRPVCCKG

£POA

DISPOSABLE SOFT VINYL GLOVES



The all purpose glove, in clear colour.
Powder-free gloves available on request.
Box of 50 pairs.

Medium

ORDER CODE: BGLVDISM

£POA

Large

ORDER CODE: BGLVDISL

£POA

X Large

ORDER CODE: BGLVDISX

£POA

POWDER FREE DISPOSABLE VINYL GLOVES

Vinyl powder free gloves are made with a unique low-friction inner polymer coating for smooth donning and are tapered at the wrist to better fit your hand. Vinyl powder gloves feature beaded cuffs for extra strength and tear resistance. Box of 100.



Medium

ORDER CODE: BPFDISGM

£POA

Large

ORDER CODE: BPFDISGL

£POA

X Large

ORDER CODE: BPFDISGX

£POA

DISPOSABLE LATEX GLOVES



The all purpose glove, in clear colour. Priced per box, 50 pairs. Powder-free gloves available on request.

Medium

ORDER CODE: BGDISLAM

£POA

NITRILE PALM COATED GLOVES



Knitted gloves with grey nitrile coated palms for better grip. Suitable for occasions where a high degree of dexterity is required. EN 388 standard. Size 9 as standard. Other sizes available on request.

Pair

ORDER CODE: BGNITPA9

£POA

SAFETY HELMET



Helmet offers electrical insulation also has slip ratchet size adjustment system with a durable shell.

Each

ORDER CODE: BPCHELMW

£POA

PROTECTOR FIRST BASE BUMP CAP



Designed for application where there may be a risk of a minor bump or scrape to the head. The design is on a fashionable baseball cap with head-protecting ABS skull cap fitted inside. Fully adjustable with air vents to improve air flow to ensure full shift wearer comfort.

Each

ORDER CODE: BPCFIBAB

£POA

HEAD PROTECTION

PPE & SAFETY - HEAD PROTECTION

CHEMI-VIEW SAFETY GOGGLES

To EN166/IF34. Anti mist and chemical protection.



Each	ORDER CODE: BCHVIGOG	£POA
------	----------------------	------

PROTECTOR MASK & VISOR

With integral chin guard. All to EN 1661:IF3



Each	ORDER CODE: BPCFASHI	£POA
Replacement Visor	ORDER CODE: BPCREPVI	£POA

3M™ SECURE FIT SPECS

The 3M™ SecureFit safety spectacles provide comfort to the wearer through the Pressure Diffusion Temple Technology which allow them to adjust to fit to all head shapes and sizes without placing pressure on the temples. The lenses are both Anti-Scratch and Anti-Fog. Standards/Approvals: ANSI Z87.1-2010, CSA Z94.3-2007



Each	ORDER CODE: BSPECSEC	£POA
------	----------------------	------

3M™ X1 SERIES EAR DEFENDER

The 3M™ Peltor™ X1 Ear Defenders are designed to offer protection against light industry noise. 3M™ Peltor™ X1 Ear Defender with standard headband. Suitable for, grounds maintenance or power drilling.



Each	ORDER CODE: BPCEDBHP	£POA
------	----------------------	------

PROTECTIVE KNEE PADS



Anti-compression gel foam gives maximum cushioning for added comfort.

Pair ORDER CODE: BKNEPD12 **£16.73**

HIGH VISIBILITY CLASS 1 WAISTCOAT



Saturn yellow 100 % solid polyester knitted fabric. Velcro fasten, black binding all round garment. 3M Scotchlite 4 x 50 mm body bands. Light weight, hard wearing, washable and colour fast. Conforms to BS EN471. When ordering specify the size you require.

Each ORDER CODE: BHYP500 **£POA**

ASPIVENIN® BITE & STING RELIEVER



Every Pest controller should have one. Aspivenin is a unique & natural treatment that brings relief from bites & stings. Aspivenin is a special vacuum mini-pump that draws poison from insect stings & insect bites.

Each ORDER CODE: BASPIBSR **£17.55**

We've made it
SUPER EASY

TO ORDER ONLINE

BarrettineEnv.co.uk



CANISTER MASKS

VISION 2 CANISTER FACE MASK



Vision 2 Canister Silicone Full Face Mask RF 1000 offers high levels of respiratory protection. Made from hypo-allergenic liquid silicone rubber and moulded in polycarbonate, which is scratch resistant.

Each

ORDER CODE: BMRF1000

£POA

PROMASK CANISTER FACE MASK



Silicone Full Face Mask

- User friendly inner mask.
- High performance speech diaphragm.
- Soft, comfortable silicone.
- Excellent field of vision.
- Filters sweep back each side - exceptional balance.

Each

ORDER CODE: BPRCANMA

£POA

AVIVA 40 HALF MASK



- Single filter half mask utilising the Pro2000 range of filters.
- Reflex seal absorbs facial movements, maintaining protection.
- Easy to use leak check mechanism.
- Goggle pinch - designed for improved eye PPE integration.
- Enhanced voice intelligibility.
- Comfortable, durable head cradle suitable for use underneath head wear.

Each

ORDER CODE: BPR40HMA

£POA

HYGENIC HALF MASK CARRY CASE



A convenient and durable carry case to hold facemasks to maintain free from external dust during storage and transport.

Each

ORDER CODE: BRESHMCC

£9.29

B2/P3 CANISTER FILTER



For use with Promask, Profile & Vision2. For use against Aluminium Phosphide, inorganic gases and vapours, dusts, mists, fumes, bacteria, and viruses. EC221R

Each

ORDER CODE: BMANB2P3

£POA

P3 CANISTER FILTER



For use with Promask, Profile & Vision2. For use against dusts, fumes, particulates and aqueous mists. EC251

Each

ORDER CODE: BMACANP3

£POA

A2/AX/P3 CANISTER FILTER



For use with Promask, Profile & Vision2. For use against organic vapour and low boiling point organic vapour, dusts, mists, fumes, bacteria and viruses. EC239

Each

ORDER CODE: BMAGEMAX

£POA

A2/P3 CANISTER FILTER



For use with Promask, Profile & Vision2. For use against organic gases and vapours dusts, mists, fumes, bacteria and viruses. EC220R.

Each

ORDER CODE: BMAGEMA2

£POA

CARTRIDGE MASKS & FILTERS

RESPIRATOR FULL FACE 3M™ 6800 MASK



The 6000 series Full Face Respirators are used with a twin lightweight filters which are fitted by a simple bayonet attachment system, providing an economical and flexible choice. The Respirators can also be used with the 3M S-200 supplied-Air System for increased convenience and flexibility. This is a medium fit, large is also available.

Each	ORDER CODE: B3M6800	£POA
------	---------------------	------

3M™ FILTER & RETAINER COVER



Note: If you require P1 or P3 filters you must incorporate A1 or A2 filters plus the retaining cover.

A1 Filter	ORDER CODE: BMA3FAA1	£POA
A2 Filter	ORDER CODE: BMA3FA2F	£POA
P1 Filter	ORDER CODE: BMA3FIA1	£POA
P3 Filter	ORDER CODE: BMA3FIP3	£POA
Retainer Cover	ORDER CODE: BMA3FRET	£POA

3M™ 7500 HALF MASK



The 3M™ 7500 half mask is a reusable soft silicone mask that is comfortable for the user to wear. The 3M™ Cool-Flow™ valve allows for easier breathing and reduced heat and moisture build-up when in use. The twin filters provide even weight distribution for added comfort and minimise obstruction of vision making it easier to use.

Each	ORDER CODE: BMA3M75H	£POA
------	----------------------	------

3M™ QUICK LATCH MASK



6500 Series Designed with tough and dirty work environments in mind. It delivers comfort, durability and stability with a firm, lightly textured silicone faceseal and strong body construction. 3M™ Cool-Flow™ valve helps to remove hot, exhaled air. 'Quick latch' design allows the respirator to be removed and re-fitted quickly and easily without disturbing other items of PPE. (Filters Sold Separately).

Each	ORDER CODE: B36500QL	£POA
------	----------------------	------

P2 - 3M™ PARTICULATE FILTER - 2125

For use with 3M™ 7500 Half Mask & 3M™ Quick Latch Mask.



Pack 2 ORDER CODE: BMANB2P3 £POA

P3 - 3M™ PARTICULATE FILTER - 2135

For use with 3M™ 7500 Half Mask & 3M™ Quick Latch Mask.



Pack 2 ORDER CODE: BMACANP3 £POA

CARTRIDGE FILTERS

A1 and P3 replacement filters for use with the Promask 2 Full Face & Profile 2 Half Mask. Sold in pairs.



P3 Filter ORDER CODE: BPROFIP3 £POA

3M™ 4255 DISPOSABLE RESPIRATOR MASKS

A2P2 Organic vapour & particulate dust protection. EN405



Each ORDER CODE: BRESP3M4 £POA

MOULDED RESPIRATORS

(EN149:2001 APPROVED)

PPE
& safety

PRODUCTS

3M™ AURA RANGE - VALVED MASKS



Introducing the 3M Aura Series disposable respirators. Features particulate filter material with advanced low breathing resistance filter technology. Gives effective filter performance whilst lowering resistance to breathing. Improved breathing ease and comfort. Effectively removes heat build up, providing a cooler and more comfortable wear. Removes exhaled air and minimises the risk of fogging eyewear.

P1 - Chemical dust or dusty area.

P2 - Valved mask for dusts/mists.

P3 Valved mask suitable for dusts, mists and fumes.

Sold in packs of 10.

P1 Filter	ORDER CODE: B3AURAP1	£POA
P2 Filter	ORDER CODE: B3AURAP2	£POA
P3 Filter	ORDER CODE: B3AURAP3	£POA

P1, P2 & P3 VALVED MASKS

Collapse Resistant double shell construction; fully sealed edge prevents fibre release; latex-free synthetic rubber head band; soft close cell foam nose piece for excellent facial seal.

P1 - Chemical dust or dusty area.

Sold in packs of 10.

P2 - Valved mask for dusts/mists.

Sold in packs of 10.

P3 Valved mask suitable for dusts, mists and fumes.

Sold in packs of 5.



P1 Filter	ORDER CODE: BRESP1VF	£POA
P2 Filter	ORDER CODE: BRESP2VF	£POA
P3 Filter	ORDER CODE: BRESP3VF	£POA

BEEKEEPERS HAT & VEIL



Soft cloth hat (one size) with black net veil attached and elastic straps which are placed under the arms to hold the veil in position. Chin strap included.

Each

ORDER CODE: BPCBHAVL

£25.62

BEEKEEPERS JACKET, HAT & VEIL



Combined hat, jacket and veil. Hat and veil is attached to the jacket with a zip which allows the hat and veil to be removed completely. Polyester cotton with elasticated wrists and waists. Top pocket and three section pockets at the front.

Medium

ORDER CODE: BBEEJVME

£58.99

Large

ORDER CODE: BBEEJVLG

£57.60

X Large

ORDER CODE: BBEEJVXL

£57.83

BEEKEEPERS ALL IN ONE COVERALL



Offering full head to ankle protection without restricting vision or movement. Polyester cotton, elasticated wrists and ankles. Hat and veil is attached to the jacket with zip and is completely removable. One breast pocket and a hive tool pocket.

Medium

ORDER CODE: BBEEALME

£87.79

Large

ORDER CODE: BBEEALLG

£87.44

X Large

ORDER CODE: BBEEALXL

£87.38

BEE & WASP PROTECTIVE CLOTHING

SHERRIFF BEEKEEPERS PC28 SMOCK & VEIL



Quick and easy to put on - with this garment you can be ready for the job in seconds! This garment has a detachable hood by means of an 'all-round-zip' at the collar. Pull front of zip half way across from shoulder to shoulder and hood can be thrown back to rest on shoulders until needed. Adjustable waist elastic with toggle adjuster. Three roomy 'Kangaroo' pockets.

Medium	ORDER CODE: BPC28SME	£121.00
Large	ORDER CODE: BPC28SLA	£121.00
X Large	ORDER CODE: BPC28SEL	£121.00

SHERRIFF BEEKEEPERS JACKET & VEIL



Code: S41Pockets: Four with velcro. Fabric: Luxury quality polycotton twill. Veil: UV resistant black nylon. Colour: White/Khaki. Size: Medium, Large, X large.

Medium	ORDER CODE: BSHBJVME	£170.63
Large	ORDER CODE: BSHBJVLA	£170.63
X Large	ORDER CODE: BSHBJVXL	£170.63

3 YEAR GUARANTEE*

SHERRIFF BEEKEEPERS ALL IN ONE COVERALL

Ref: S36, Sizes: M, L, & XL. Colour: White/Khaki. Fabric: Quality Polycotton. Well made and a good fit, comfortable to wear and incredible value. Larger sizes available on request. *3 Year Guarantee (T&C's apply).



Medium	ORDER CODE: BSHBAOME	£220.00
Large	ORDER CODE: BSHBAOLA	£220.00
X Large	ORDER CODE: BSHBAOXL	£220.00

PLASTACHROME GLOVE/GAUNTLET



Hardwearing, washable. In sizes medium, large and X large. Complete with twill elasticated gauntlets. Sold in pairs.

Medium	ORDER CODE: BGLBEE70	£11.12
Large	ORDER CODE: BGLBEE80	£11.37
X Large	ORDER CODE: GLBEE90	£11.37

MORDANT LEATHER GLOVE



Mordant gloves are well made and a good fit, comfortable to wear and incredible value. Supplied with twill elasticated gauntlets. Sold in pairs.

Small	ORDER CODE: BGLBLM60	£18.87
Medium	ORDER CODE: BGLBLM70	£18.86
Large	ORDER CODE: BGLBLM80	£18.82
X Large	ORDER CODE: BGLBLM90	£18.82

WASHABLE TAN LEATHER GLOVE



A quality washable leather glove.

Small	ORDER CODE: BSHGLOSM	£38.63
Medium	ORDER CODE: BSHGLOME	£38.63
Large	ORDER CODE: BSHGLOLA	£38.63

ASPIVENIN® BITE & STING RELIEVER



Every Pest controller should have one. Aspivenin is a unique & natural treatment that brings relief from bites & stings. Aspivenin is a special vacuum mini-pump that draws poison from insect stings & insect bites.

Each	ORDER CODE: BASPIBSR	£17.55
------	----------------------	--------

BAGS & CARRY CASES

TOOL BACKPACK



Heavy-duty polyester back pack with padded back and straps for extra comfort when carrying. A solid base increases the strength allowing the bag to be utilised for carrying pest control products. Main compartment with internal compartments, and additional side pockets for additional storage.

Each	ORDER CODE: BRUCKHDB	£33.00
------	----------------------	--------

HEAVY DUTY BAG (ON WHEELS)



This heavy duty bag is ideal for holding pest control products and for ease of transportation it comes on wheels with a robust metal handle making it easier to manoeuvre. Complete with multiple internal and external pockets, and a large compartment with zip.

Each	ORDER CODE: BPEBAGWH	£72.68
------	----------------------	--------

PESTICIDE CARRY BAG QD 45



A segmented bag for carrying around tools equipment and pesticides. Company logo/brand can be added for a small charge. Available with or without internal dividers.

Without Divider	ORDER CODE: BPECABND	£19.16
With Divider	ORDER CODE: BPECABAG	£29.50

PESTICIDE CARRY BAG QD 80



As above but a better quality bigger version with two end pockets. Company logo/brand can be added for a small charge. Available with or without internal dividers.

Without Divider	ORDER CODE: BQD75BND	£31.15
With Divider	ORDER CODE: BQD75BAG	£35.15

B & G HARD SHELL CARRY CASE



The B&G hard shell carrying cases can hold sprayers and or additional equipment. The case has rigid snap locks that accept padlocks and it is also fitted with child-resistant latch built into the lid.

Each

ORDER CODE: BBGCCASE

£99.39

TRANSCHEM CASE



For secure transport of chemicals in cars, vans etc. May be fully locked with snap lock hinges. Non-slip base to prevent movement when braking. Dimensions: Base - 430 mm x 355 mm, Top - 460 mm x 385 mm, Height 400 mm. Extra carriage charge £20.00.

Each

ORDER CODE: BTRACHEM

£206.89

CHEMLOCK® PEST PARTNER



The PEST Partner box (yellow) can be used as a stand-alone box or used in conjunction with a Chemlock® DUAL transport box (green). The DUAL box acts as a "mother box" providing double fume protection. One or two PEST PARTNER boxes can be housed in DUAL box.



Pest Partner

ORDER CODE: BCHEMLPP

£223.95

Dual Box

ORDER CODE: BCHEMLDB

£357.28

CHEMICAL SPILLAGE KITS

VAN SPILLAGE KIT



A quality spill kit with an economical clear out. Great for absorbing oil, fuel & mild chemical spills up to 20 litre Ideal to keep in the van, cab, garage, warehouse, site or depot.

Each

ORDER CODE: BBIP0120

£POA

CHEMICAL STORE SPILLAGE KIT



Covers up to 15 litre spillages of hazardous liquids. The kit contains ten large chemical absorbent pads, two chemical absorbent socks, one instruction sheet and two disposal carry bags & ties. Every chemical store should have one.

Each

ORDER CODE: BBIP0123

£POA

POLVO POWDER



Polvo comes as a super-absorbent powder for any spillages (from insecticides to paint to 'body fluids') - ideal for the van, stores or even as a sell-on. Polvo Powder is an inert mineral, and due to its extremely fine granular structure, it completely absorbs the spill within itself. The spill is prevented from spreading and is absorbed to a point that it can be cleaned up leaving a slip-free surface that is residue-free.

1 x 5 Litre

ORDER CODE: BPOLPO5K

£25.12

EMERGENCY SHARPS DISPOSAL KIT



The sharps disposal kit contains one pair of latex gloves, one medi wipe, one pair of tweezers, one small sharps bin, one instruction sheet and one bio-hazard disposal bag. Sharps Hypodermic collecting gloves are also available.

Each

ORDER CODE: BBIP0215

£POA

SHARPS BIN



Can be used in conjunction with Sharps Hypodermic collecting gloves. See gloves section.

1 x 4 Litre Bin

ORDER CODE: BSB96006

£POA

SELF-ADHESIVE LABELS & SIGN



SELF-ADHESIVE LABELS

80 x 80 mm

ORDER CODE: BHAZSIGS

£3.58

300 x 300 mm

ORDER CODE: BSIGNWAR

£11.66

SIGN

Hard rigid plastic board. 300 mm x 300 mm

Each

ORDER CODE: BHAZSIGL

£13.95

FIRST AID KITS



Ideal for use in stores, vans, offices etc.

Each

ORDER CODE: BHFIR003

£POA

EYE WASH STATION



Contains two eye pads and two 500 ml eye wash bottles.

Each

ORDER CODE: BHEYE366

£POA

REPLACEMENT EYE WASH 500 ml

Each

ORDER CODE: BHEYE375

£POA

HYGIENE & DISINFECTANTS

75% ALCOHOL SURFACE CLEANER



Barrettime 75% Alcohol Surface Cleaner has been formulated as an effective broad-spectrum ready to use solution against bacterial and fungal pathogens. Tested to BS EN 1276 and BS EN 13697 (effective against *E. coli*, *E. hirae*, *S. aureus* and *P. aeruginosa*).

- 75% Alcohol active ingredient
- Ready to use formulation
- Universal surface cleaner
- Easy application

6 x 500 ml	ORDER CODE: BSURF500	£17.40
2 x 5 Litre	ORDER CODE: BSURF5LT	£35.16

ALCOHOL HAND SANITISER (WHO RECOMMENDED FORMULA)



Barrettime Alcohol Hand Sanitiser is manufactured to World Health Organisation Formulation 2 standards and can be used as a versatile liquid hand rub. This product is manufactured under an official derogation from the HSE under the biocides directive.

- Made to official recognised WHO standards
- Effective & convenient hand sanitiser
- Ready to use formulation
- Economical
- Easy application

6 x 500 ml	ORDER CODE: BHAND500	£15.60
2 x 5 Litre	ORDER CODE: BHAND5LT	£29.00

DUOMAX DISINFECTANT



DuoMax is the latest addition to the Barrettime product range that combines a strong disinfectant with a cleaner that has excellent virucidal and antibacterial properties.

- Removes risk of viral, bacterial and fungal cross contamination of surfaces
- Applies a fighting residual barrier
- Ready to use
- Can be used on all hard surfaces including, plastics, keyboards etc

DuoMax has successfully passed test BS EN 14476 (2005) – Chemical disinfectants and antiseptics, Virucidal quantitative suspension test for chemical disinfects against CORONAVIRUS. DuoMax has the following test data: EN 1276, EN 1650, EN 13704, EN 14476.

1 x 5 Litre	ORDER CODE: BDUOMAX5	£23.00
-------------	----------------------	--------

DUOMAX DISINFECTANT WIPES



DuoMax is the latest addition to the Barrettime product range that combines a strong disinfectant with a cleaner that has excellent virucidal and antibacterial properties.

- Removes risk of viral, bacterial and fungal cross contamination of surfaces
- Applies a fighting residual barrier
- Ready to use
- Can be used on all hard surfaces including, plastics, keyboards etc

DuoMax has successfully passed test BS EN 14476 (2005) – Chemical disinfectants and antiseptics, Virucidal quantitative suspension test for chemical disinfects against CORONAVIRUS. DuoMax has the following test data: EN 1276, EN 1650, EN 13704, EN 14476.

200 Wipes	ORDER CODE: BDUOW200	£7.95
-----------	----------------------	-------

WEPALM HAND SANITISER DISPENSER & REFILL POUCH



Use our cost effective top up system & save money and time! WePalm hand sanitiser comes in easy to store, easy refill pouches. Made with a synergistic blend of detergents to provide a mild but thorough cleaning and sanitising action. With its skin friendly sanitising, cleaning and moisturising action, it allows constant use in catering/kitchen areas, hospitals, nursing homes and can be mounted inside a pest control vehicle for ease of action & access. Once dispensed, produces a pre-lathered foam. The spread-ability of the foam increases the cleaning and disinfecting performance, getting to areas such as in-between the fingers where bacteria hide. Used in conjunction with our pump action dispenser that does not rely on battery operation to provide further cost savings. Complies to BS EN 13727, 13624, & 14476. BPR compliant

Dispenser	ORDER CODE: BSOAPDIS	£12.31
Pouch 1 x 6	ORDER CODE: BHANDSOA	£23.08

**KILLS
LEPTOSPIROSIS**

GUANAWAY & GUANAWAY RTU



Disinfectant and cleaner for use with the cleaning up bird waste, kills fungi associated with bird droppings. Unlike other products, Guanaway is a powerful alkaline cleaner degreaser that neutralises the acidic by-product associated with bird droppings. This reduces the damage to the stonework and increases safety by removing the slippery, greasy waste. Also available as a handy RTU trigger spray version ideal for those small jobs when making up a full sprayer isn't justified. Ideal for disinfecting traffic lights, as it won't discolour plastic.

750 ml - RTU (Trigger Spray)	ORDER CODE: BGUANRTU	£8.75
6 x 750 ml - RTU (Bulk Pack)	ORDER CODE: BGURTUBP	£41.54
1 x 5 Litre (Concentrate)	ORDER CODE: BDISB005	£39.80

PARVO KILL



Passes virucidal effectiveness test against canine parvovirus at a dilution of 1-35 in water. Parvo-Kill has been formulated to be a true dual-purpose product for cleaning and disinfecting high-risk areas. It can also be used for general cleaning and disinfecting of hard surfaces e.g. sinks, worktops & pre/post animal housing at a rate of 1-100 in water.

1 x 5 Litre 'While stocks last'	ORDER CODE: BPARV005	£23.35
------------------------------------	----------------------	--------

SORGENE XTRA



Sorgene Xtra is a broad spectrum disinfectant highly effective in farm conditions against bacteria, viruses and fungal spores. Sorgene Xtra has DEFRA approval for 3 notifiable diseases (foot-and-mouth, poultry orders and general orders) and lower dilution rates, compared to Sorgene 5, on some diseases.

1 x 5 Litre	ORDER CODE: BSORG005	£54.58
-------------	----------------------	--------

HYGIENE & DISINFECTANTS

PPE & SAFETY - HYGIENE & DISINFECTANTS

BACTERICIDAL HAND SOAP



A high-quality pearlescent bactericidal liquid hand soap. Fragrance-free for use in the food & catering industry. Provides a rich lather that is mild and gentle with a thorough cleaning & sanitising action. Ideal for topping up soap pump dispensers.

1 x 5 Litre	ORDER CODE: BHACL005	£11.22
-------------	----------------------	--------

NILAQUA 'ALCOHOL FREE' HAND SANITIZER



Nilaqua is a fragrance & alcohol-free advanced hard surface / multi-surface cleaner and hand sanitiser that is fast-acting and a powerful germ killer (99.9999%), effective within 30 seconds yet kind to the individual and environment, not stripping surfaces as it contains no irritants within its formulation.

1 x 500 ml	ORDER CODE: BNWRH005	£7.09
1 x 5 Litre	ORDER CODE: BMT5KTUB	£26.65

KNOCKOUT® BLACK DISINFECTANT



Maximum strength, general outdoor disinfectant & cleaner. Removes bad smells from drains and bins, disinfects and removes bacteria, moss and algae from paths, patios, driveways, greenhouses, pet housing and greenhouses.
Note: Not for indoor use. Do not use neat unless stated on the tin.

6 x 1 Litre	ORDER CODE: BKODB001	£POA
-------------	----------------------	------

KNOCKOUT® BIOLOGICAL DRAIN TREATMENT



An eco-friendly, enzyme-based biological formulation to clear slow flowing waste pipes in the bathroom and kitchen. Use regularly as a maintenance product. Safe to use on septic tanks.

6 x 1 Litre	ORDER CODE: BKODD001	£POA
-------------	----------------------	------

KNOCKOUT® CAUSTIC SODA



Granules for dissolving in cold water to clear block drains and clean surfaces. Can be used to strip paint. Will need neutralising with white vinegar. Age restricted.

18+

500 g	ORDER CODE: BCSA6.50	£POA
1 Kg	ORDER CODE: BCSA6001	£POA
4 Kg	ORDER CODE: BCSAK004	£POA

KNOCKOUT® TOILET & DRAIN UNBLOCKER



For trade and professional use only. Sulphuric Acid based product (with inhibitor) specially designed to rapidly clear blockages in outside drains, pipes and toilets. (Industrial strength for trade and professional use). Not recommended for use with septic tanks. For other blockages use Knockout® Sinks, Showers & Baths. Age restricted.

18+

4 x 1 Litre	ORDER CODE: BKOAK001	£POA
-------------	----------------------	------

LITTER PICKER 102



Top quality litter picker 102 cm long. Ideal for picking up sharps and needles plus anything else that you don't want to handle. Can also be used for retrieving and placing baits in awkward places.

Each	ORDER CODE: BLPICLP3	£17.36
------	----------------------	--------

LONG HANDLE SCRAPER



An excellent tool for scraping up all sorts of horrors such as bird muck, grease and grime etc. Comes complete with a replaceable 200 mm x 1.3 mm stainless steel blade and 1300 mm handle.

Each	ORDER CODE: BSCRMSC1	£21.13
Spare Blade	ORDER CODE: BSCSPBLA	£3.50

CLEANING TOOLS

HAND SCRAPER



Stainless steel 75 mm x 0.8 mm blade with plastic hand grip.

Each

ORDER CODE: BHASCRAP

£7.82

WIRE BRUSH WITH SCRAPER



Tough wire brush and metal scraper.

Each

ORDER CODE: BWBSCR26

£3.86

MINI-GRABBER



A mini 'grabber' designed to be easily carried in your pesticide bag, allowing you to professionally and hygienically remove items such as dead rodent bodies without having to come into contact with them. Approximately 30 cm long.

Each

ORDER CODE: BMINIGRB

£7.37

BROOM, SPADE, DUSTPAN & BRUSH



BROOM

A 24" Platform broom with natural Coco filled head. Supplied complete with 48" stayed handle.

SPADE

A metal square open mouth Bulldog shovel.

DUSTPAN & BRUSH - Plastic

Broom

ORDER CODE: BAWBROOM

£9.78

Spade

ORDER CODE: BAMSPADE

£42.91

Dustpan & Brush

ORDER CODE: BADUSTPB

£2.48

MINI MAGLITE AA



The small pocket size Maglite torch.
Requires 2 x AA size batteries. Blister pack includes batteries and spare bulb.

Each

ORDER CODE: BTMINMAA

£19.72

MAG CHARGER SYSTEM



A highly engineered lighting tool. Complete with rechargeable (1,000 x) battery pack plus adaptors for both the office & the car. State of the art electroformed reflector, incredibly bright high-intensity halogen lamp and solid-state electronics throughout.

Each

ORDER CODE: BTMAGCHA

£147.43

MAGLITE 3D CELL TORCH



This torch requires 3 x LR20 batteries. Unit conforms to the same standard as the Mag Charger system.

Each

ORDER CODE: BTMAG3DC

£35.88

Spare Bulb

ORDER CODE: BTMAG3BT

£5.09

ULTRAVIOLET FOCUSING LED TORCH



This 395nm LED UV torch delivers fantastic performance of 20,000 hours for a lifetime of owner satisfaction. The aircraft aluminium construction torch will give up to 8 hours burn time from one set of batteries. The torch also has a spot to flood focus feature. Constructed of tough aluminium it is designed to give a reliable and long service life. Comes with a tube extender so that you can use either 3 x AAA alkaline batteries or 1 x 18650 Li-ion battery. Ideal for fluorescent tracking.

Each

ORDER CODE: BUVTORCH

£45.46

TORCHES, TOOLS & LADDERS

ULTRAVIOLET TRACKER TORCH

Ideal for use with tracking dusts, non toxic fluorescent baits as well as fluorescent rodenticides.



Each

ORDER CODE: BUVTLAMP

£22.47

P2-2 ALUMINIUM PEN TORCH

A 275 lumens white CREE LED Focus Control torch also known as the police tactical torch due to its brightness, size and durability. It is dust and waterproof IP66, 2 light mode settings, flawless smooth reflector for long distance beam. Up to 15 hours run time and 9 m range. Battery type: 2 x AAA size Duracell Alkaline Batteries (Included). Pocket clip attachment included.



Each

ORDER CODE: BTOUPT-2

£22.63

PS-IL10R INSPECTION LIGHT

The ultimate high-powered rechargeable inspection light, delivering an impressive 1000 lumen output, from the latest SMD LED technology. It has superior portability in the form of its integral hanging hook, foldable kick stand and strong magnet which all allow for easy hands free use. The PS-IL10R's battery life stands at 3-32 hours runtime. BATTERY: 3.7 5000 mAh Li-ion rechargeable battery WEIGHT: 338 g with Battery. DIMENSION: 205 x 60 x 42 mm



Each

ORDER CODE: BTOUIL10R

£62.46

MINT MAGNETIC TORCH

The perfect tool for any need, this double magnetic LED work light is great for attaching to any metal surface for optimal lighting. This aluminium flashlight allows you to extend from its normal size of 17cm to 58cm allowing you to pick up items that are stuck in hard to see and reach places with the magnet on front. This flashlight is equipped with three LED for extra bright exposure in dark spaces. When the light is extended the head becomes flexible and can be adjusted in any direction. Includes batteries for direct use.



Each

ORDER CODE: B PROMO

£15.10

REPLACEMENT BATTERIES

Replacement battery for use with lantern style torches.



AA Batteries x10

ORDER CODE: BTOBATAA

£5.91

AAA Batteries x10

ORDER CODE: BTOBAAAA

£5.91

MAGNETIC PICK UP & MIRROR SET

The perfect tool for pest control inspections. This two piece set comes with a magnetic pick-up tool that has a 6 section extension and a mirror with 5 section extension. The mirrored end is mounted on twin ball joints for maximum rotation. The magnet has an LED to illuminate dark areas.



Each

ORDER CODE: BMAGTELP

£18.08

FLEXIBLE PICK UP CLAW

This two piece flexible pick-up tool set is lightweight and ideal for reaching items in hard to reach places. One complete with a pick-up claw to grab items and the other complete with a magnetic head for metal detectable items. A great tool for any pest controller.



Each

ORDER CODE: BCLATELP

£10.95

DEWALT CORDLESS COMBI DRILL*



DeWalt 18V 2.0AH Li-Ion XR Brushless Cordless Combi Drill. Compact and ergonomic combi drill with 18V brushless motor and XR technology. Features include 65mm max torque, intelligent trigger design and spindle lock for a quick and easy bit change—ideal for consistent screw driving into a variety of materials with different screw sizes.

- 2 x 2.0Ah Li-Ion Batteries • 90min Charge Time • Max. Torque: 65Nm
- 15 Torque Settings + Drill + Hammer Drill • 13mm Keyless Chuck
- 2-Speed Variable & Reverse • All-Metal Gearing • Brake
- LED Work Light • Spindle Lock

*Models may vary.

Each

ORDER CODE: BDRIL18V

£147.69

TORCHES, TOOLS & LADDERS

HANDHELD VACUUM CLEANER WET/DRY

This cordless vacuum cleaner is ideal for quick clearing up of spillages of both solid products and liquids. The removable collection chamber allows the vacuum to be easily emptied ready for next use. Comes complete with detail brush, squeegee brush, storage bag and reusable filter.



Each

ORDER CODE: BVACUWDC

£49.14

TELESCOPIC TELESTEPS

A brilliant quality design. The ladder extends from just 90 cm to 3.8 m. Lightweight aluminium construction weighs just 9 Kg but allows a safe working load of 150 Kg. The ladder conforms to EN 131. Additional carriage charges may apply.



Each

ORDER CODE: BTELESTP

£201.10

UNIVERSAL FOLDING LADDER 4x3

Described as 'the most versatile ladder in the world'. This ladder can fold into different working positions and can be used as a single ladder, step ladder, work platform etc. Comes complete with platform boards and splayed base. In addition it folds down easily to fit into the back of a van or car boot. Made from titanium anodised aluminium (EN131 European standard). Additional carriage charges may apply.



Each

ORDER CODE: BUNA43EP

£175.71

LADDER CLAMP

Safely and securely allows you to transport your ladders on your vehicles roof rack whilst travelling.



Pair

ORDER CODE: BLADCLAM

£27.58

A GUIDE TO THE BARRETTINE RANGE OF PERSONAL PROTECTIVE EQUIPMENT COSHH AND PPE REGULATIONS

The COSHH Regulations 2002, as amended in 2003 and 2004 are a key part of health and safety at work. The regulations place a legal requirement on all employers and operators including self-employed people to undertake an assessment of the risks created by exposure to any substances hazardous to health. The risk assessment shall include consideration of the hazardous properties of the substance, manufacturers information contained in any material safety data sheet, the level and type of duration of exposure, working circumstances and other factors relating to exposure limits, control measures etc.

The COSHH amendment Regulation 2004 which came into force on 1st April 2005. It introduced a new framework of adequate control of exposure by specifying principles of good practice (Schedule 2A) and by replacing occupational exposure standards (OES's) and Maximum Exposure levels (MEL's) with workplace exposure limits (WEL's).

The Personal Protective Equipment Regulations 1992 require that where PPE is issued it must be suitable for the task for which it is required, and it must take into account the demands it places on the worker. It must be maintained in good condition and stored when not in use in a clean cabinet or container.

What does this mean to you?

The provisions make the duty holders focus on applying principles of good practice to controlling exposure rather than compliance with any OEL. (Schedule 2A)

This has the effect of bringing into the definition of adequate control all substances within the scope of the COSHH regulations, irrespective of whether they have an OEL, and all routes of exposure i.e. inhalation, absorption and ingestion and injection. It is now accepted that it is not possible to give a "Safe limit" as before because in practice a guarantee for health protection for all individuals, even if exposure is below a specified limit, is not scientifically secure.

The revised system of WEL's will be set by the advisory committee on toxic substances (ACTS). These are listed in a publication EH40-2005. There is a specific WEL values in Table 1 for all substances. The WEL value is a limit that must not be exceeded and there is a duty, similar to the previous regulations, to ensure adequate control and to reduce exposure as far as possible.

The amendments to COSHH should make it easier for enforcers and duty holders to determine whether exposures to substances are adequately controlled and proportionate to the risk.

As part of the Barrettine professional services, we have available qualified COSHH Consultants who are able, on a fee basis, to undertake COSHH Assessments and preparation of COSHH documentation for our customers, as well as being able to define the personal protective equipment required in the specific situations encountered by our customers. In addition we are happy for our staff to offer advice, at no charge, on the level of protection required in applying and using any of the PPE products which we offer as part of our Technical Sales Service to our customers.

Schedule 2A

Principles of good practice for the control of exposure to substances hazardous to health.

The eight principles of good practice for the control of exposure to substances hazardous to health are set out in Schedule 2A of The Control of Substances Hazardous to Health Regulations 2002 (as amended). Approved Code of Practice and guidance .

The principles are reproduced below:

- (A) Design and operate processes and activities to minimise emission, release and spread of substances hazardous to health;
- (B) Take into account all relevant routes of exposure - inhalation, skin absorption and ingestion - when developing control measures;
- (C) Control exposure by measures that are proportionate to health risk;
- (D) Choose the most effective and reliable control options which minimise the escape and spread of substances hazardous to health;
- (E) Where adequate control of exposure cannot be achieved by other means, provide, in combination with other control measures, suitable personal protective equipment;
- (F) Check and review regularly all elements of control measures for their continuing effectiveness;
- (G) Inform and train all employees on the hazards and risks from the substances with which they work and the use of control measures developed to minimise the risk;
- (H) Ensure that the introduction of control measures does not increase the overall risk to health and safety. If employers apply the principles correctly, exposure should be below any relevant WEL. Control by personal protective equipment should only be used when other measures are not reasonably practicable. The list of WEL's applies to concentrations of hazardous substances breathed in by the worker and are used to determine the adequacy of control measures. There are several publications, which give advice and guidance on what is required under the COSHH Regulations.

Regulation 7 COSHH 2002. Fit Testing of Facepieces

The performance of RPE with a tight-fitting facepiece (filtering facepieces, half and full full-face masks) depend on a good contact between the wearer's skin and the face seal of the mask. A good face seal can only be achieved if the wearer is clean-shaven in the region of the seal and the facepiece is the correct size and shape to fit the wearer's face. Employers should ensure that the selected facepiece (tight and loose fitting types) is of the right size and can correctly fit each wearer. For a tight-fitting facepiece (filtering facepieces usually known as disposable masks, half and full face masks) the initial selection should include fit testing to ensure the wearer has the correct device. Barrettine can advise customers about this requirement.

WHY CHOOSE BARRETTINE?



WHY CHOOSE BARRETTINE AS YOUR PREFERRED SUPPLIER?

QUALITY PRODUCTS

As well as working directly with the key major Biocide Manufacturers, Barrettine manufacture and source a fantastic wide range of products, many of which are award-winning, helping you and your business to stay ahead.

Discretion is key. We're not your competitor!

Unlike some other distributors we are careful how and where product prices are displayed.

Our products are only sold to qualified Pest control Companies/ Technicians or recognised distributors with appropriate facilities.

TECHNICAL SUPPORT, PRODUCT STEWARDSHIP, REGULATORY & LEGISLATIVE UPDATES.

Professional products are only sold onto qualified/competent personnel that can demonstrate they have the required training and qualifications.

QUALIFIED STAFF

Barrettine at the heart of our Industry, constantly update Customers with the ever-changing regulatory & legislative issues we must implement. A number of Barrettine staff represent the company and the Industry within a number of independent bodies and organisations such as the BPCA, NPTA & CRRU.

TRAINING

Barrettine is a Lantra approved Training provider have put together a number of excellent, independent and recognised training courses to help support your business, your staff & colleagues. Contact the Sales office for further information.

FREE INSECT ID

From an independent industry-leading entomologist, quick and easy and free to our Customers.

LICENSED WASTE TAKE BACK SCHEME

(Full document available on request)

Barrettine Environmental Health (Barrettine) understands its business activity and any potential impact this may have on the environment. We are proud to hold the Environmental Management ISO14001 certification and as a responsible business see that a products life from cradle to grave is an essential part of environmental protection and management.

As such we are pleased to provide a waste scheme for our customers helping them to demonstrate their duty of care with regards to waste disposal by offering a fully compliant waste scheme. Barrettine working directly with the Environment Agency have put together a comprehensive and approved waste take back scheme.

Barrettine is a registered Hazardous Waste Transfer Site. Our environmental permit number is EPR/CB3001UB. (Full document available on request).

BARRETTINE GROUP CORPORATE & SOCIAL RESPONSIBILITY

(Full policy document available on request)

We recognise that we must integrate our business values and operations to meet the expectations of our stakeholders. This includes our Customers, Employees, Investors, Suppliers, the Community and the Environment.

The Board of Directors supports this principle and the aim of our full policy is to translate this into guidelines, standards and actions that set a common approach for all employees within our Business.

PURPOSE & AIMS

The Barrettine Group Mission is:

- To enhance our expertise in our key Business activities; Chemical Formulations, Chemical Products, Chemical Handling, Biocides & Product Development.
- Give priority to Customer service and Flexibility
- Offer value for money, Sustainable Products & Services that meet the demands of our Customers and markets, whilst being acceptable to the Environment.
- Target and achieve the highest quality standards in all we do.
- Honesty & Integrity, Always Trustworthy

These core values continue to help us achieve our overall objective; A strong performing business respected by our Customers & Supply Partners, envied by our Competitors.

CODE OF BUSINESS ETHICS

We recognise that good CSR embraces all aspects of sustainable development and the way we affect people through our business operations. Therefore, our CSR applies to all of the operations of the Company and its subsidiaries and sets out the minimum standards expected from staff in their internal and external dealings with colleagues, customers, stakeholders and third parties.

Our full range of policies cover: Employees - Equality - Human Rights - Modern Slavery - Environment - Quality Control - Sustainability - Impact on society - Ethics & Ethical Trading.

ENVIRONMENT

ISO 14001 Standard.

(Full Environmental Policy available on request)

QUALITY MANAGEMENT SYSTEM

ISO 9001 Standard. (Full policy available on request)

SUSTAINABILITY - IMPACT ON SOCIETY - ETHICS AND ETHICAL TRADING

(Full policy document available on request).

- Our Sustainable policy will be maintained and it sets out the principles, policies and procedures on which sustainable business activity within Company will be based. The policy acts as a prompt to staff to consider sustainability as a factor in all key decisions;
- We take steps to understand how we can most effectively support the needs of the local and wider community and implement initiatives accordingly; A number of Charities are supported by both the Business as well as individual Employee fundraising events.

TOTAL SERVICE

- Barrettine strive to complete your order and deliver next day, we will always advise if there are any issues beforehand.
- A full competitive package. We will do our best to match, or beat any price on offer.

MORE THAN JUST A SUPPLIER.

A true partner to support your business, the right Chemistry!



Bird control RSPH Level 2
TRAINING COURSES
Insect control
 Development

E-Learning
LANTRA PROVIDER

2020 Knowledge CPD POINTS
Rodent control

ABILITY
 EXPERIENCE
 SKILLS
 GROWTH



BARRETTINE TRAINING COURSES

ALL COURSES ARE AVAILABLE AT

www.barrettineEnv.co.uk

Barrettine offer a wide range of excellent, independent and recognised training courses to help support your business, your staff & colleagues. If you require further information about availability and course prices please visit our website or contact Carly in our Sales Office.

Email: training@barrettine.co.uk

Please note: We offer bespoke courses tailored to your company dependent on numbers of delegates attending.





A-Z INSECT control

PRODUCTS 

The following charts have been produced only as an aid in product selection. In all circumstances you should always read the product label. The information given is to the best of our knowledge and is given in good faith. We can not accept any responsibility for loss or damage arising from any error or omission. Certain information such as Personal Protective Equipment (PPE) requirements are only our recommendation and are provided as a guide and in no way should they replace any part of your COSHH assessment. Under certain conditions you may require additional PPE. You should always refer to the product MSDS before use.

ACCLAIM AEROSOL

ACTIVE %	SPECIES EFFECTIVE AGAINST	AREA OF USE	DILUTION/ DOSE RATES	APPLICATION TECHNIQUE	PPE REQUIRED	RESIDUAL OR KNOCKDOWN
s-Methoprene 0.09 % (w/w), Permethrin 0.94 % (w/w)	Fleas.	Pet bedding, Carpets, Rugs, Upholstered furniture (inc. cracks and crevices in the floor)	Ready-to-use Aerosol. One can covers 140 m ²	Remove all pets and people from the room; hold can upside down and away from your body using a sweeping motion apply a fine spray - Spray uniformly across surfaces from a distance of about half a metre.	For professional operators: wear suitable protective gloves and respiratory equipment in case of insufficient ventilation.	Short-term insecticide - Long-lasting IGR (up to 12 months).

ACTELIC 50EC

ACTIVE %	SPECIES EFFECTIVE AGAINST	AREA OF USE	DILUTION/ DOSE RATES	APPLICATION TECHNIQUE	PPE REQUIRED	RESIDUAL OR KNOCKDOWN
Pirimiphos-Methyl 49.02 % (w/w)	Saw-toothed grain beetle, Grain weevil, Common flour mite, Warehouse moth, Flour or Mill moth, Flour beetles, Rust-red grain beetle and Cosmopolitan food mite.	Application as a grain admixture must only be made using automated application equipment.	Admixture: stored wheat, barley and oats - 8 ml product /tonne grain. One per batch of grain. The maximum concentration must not exceed 8 ml product/0.75 litres water.	Complete admix or surface mix including conveyor application.	For general use: Full face mask or 1/2 mask with goggles/ face shield, nitrile gloves and chemical-resistant coveralls - When used in confined areas such as Ship-holds powered respirators or breathing apparatus.	Residual treatment to grain.

ALPHA SCT

ACTIVE %	SPECIES EFFECTIVE AGAINST	AREA OF USE	DILUTION/ DOSE RATES	APPLICATION TECHNIQUE	PPE REQUIRED	RESIDUAL OR KNOCKDOWN
Cypermethrin 10 % (w/w), Tetramethrin 0.9 % (w/w)	Flies, Moths, Beetles, Fleas, Ticks, Bed bugs, Cockroaches, Crickets, Silverfish, Booklice, Mites, Ants, Mosquitoes, Wasp and Centipedes.	For use in and around domestic properties, public and municipal areas, refuse tips, poultry houses, slaughterhouses and manure heaps.	Routine treatment - Dilute 25 ml in 5 L of water and apply at a rate of 50 ml per sq/m - Heavy infestations: Dilute 50 ml in 5 L of water and apply at a rate of 50 ml per sq/m.	A suitable hand or mechanical sprayer can apply as a coarse spray and apply at a rate of 50 ml per sq/m.	Coveralls, synthetic rubber/ PVC gloves, face shield - If spraying in confined places, full face mask or half mask with goggles and suitable filters.	Residual surface spray.

AQUAPY

ACTIVE %	SPECIES EFFECTIVE AGAINST	AREA OF USE	DILUTION/ DOSE RATES	APPLICATION TECHNIQUE	PPE REQUIRED	RESIDUAL OR KNOCKDOWN
Chrysanthemum Cinerariaefolium Extract 3.00 % (w/w) synergised with Piperonyl Butoxide	Flying Insects, e.g. Flies, Mosquitoes, Stored product moths and Tobacco beetles - Wasps-by treating in and around the nest - Crawling Insects: as an aid to the control of, e.g. Cockroaches, Bed bugs, Fleas, Saw-toothed grain beetles, Grain weevils, Flour beetles, Grain borers, Mealworm beetles, Leather beetles and Tobacco beetles.	Domestic private dwellings - Food Handling: Processing, Food manufacture, Kitchens, Slaughterhouses, Bakeries, Mills etc. - Storage: Food retailers, Warehouses, Raw material stores etc. - Preparation: Restaurants, Commercial kitchens.	Ready to use please refer to product label for application rate.	Can be used indoors and outdoors as a space spray, surface, mist / fog or ULV application.	Full face mask or half mask with goggles, chemical-resistant gloves and coveralls.	Residual effect depends on dilution rates used - Refer to label for full details.

AQUATAIN

ACTIVE %	SPECIES EFFECTIVE AGAINST	AREA OF USE	DILUTION/ DOSE RATES	APPLICATION TECHNIQUE	PPE REQUIRED	RESIDUAL OR KNOCKDOWN
A unique silicone based liquid for Mosquito, Larvae and Pupae control.	Can be used on all mosquito species; the film prevents pupae and larvae from attaching themselves at the surface while attempting to breathe, thereby causing them to drown.	For use on open water bodies and underground systems.	Ready-to-use.	Measuring cylinder or sprayer applied.	Safety glasses and impermeable gloves when handling.	Knockdown.

BAYER FLYING INSECT KILLER

ACTIVE %	SPECIES EFFECTIVE AGAINST	AREA OF USE	DILUTION/ DOSE RATES	APPLICATION TECHNIQUE	PPE REQUIRED	RESIDUAL OR KNOCKDOWN
d-Tetramethrin 0.15 % (w/w) and 1R-Trans Phenothrin 0.15 % (w/w) Also contains propellants: Propane, butane and isobutane.	A pre-pressurised handheld aerosol for use against Flying insects such as Flies, Mosquitoes and other small flying insects by application as a space and surface spray - Can also be used against crawling insects such as Ants, Bed bugs, Cockroaches and Fleas.	Indoors only.	Refer to label.	Ready-to-use aerosol.	Wear suitable protective clothing and suitable gloves.	Rapid control and quick knockdown.

BIOPREN 6 EC

ACTIVE %	SPECIES EFFECTIVE AGAINST	AREA OF USE	DILUTION/ DOSE RATES	APPLICATION TECHNIQUE	PPE REQUIRED	RESIDUAL OR KNOCKDOWN
s-Methoprene 6.74 % (w/w), Pyrethrin 4.81 % (w/w), Piperonyl Butoxide 10.17 % (w/w)	Bed bugs and Fleas, both as a flushing agent and knockdown insecticide.	For Indoor use against Blood sucking insects (Bed bugs & Fleas) and other crawling insects in surfaces, cracks, crevices, carpets, soft furnishings, mattresses, pet housing and pet bedding.	Bed bugs-dilute 1 ml of product to 100 ml of water - Fleas-dilute 1ml of product to 250 ml water.	A suitable hand or mechanical compression sprayer.	Full face mask or half mask with goggles, chemical-resistant gloves or coveralls.	Residual.

BIOPREN BMS

ACTIVE %	SPECIES EFFECTIVE AGAINST	AREA OF USE	DILUTION/ DOSE RATES	APPLICATION TECHNIQUE	PPE REQUIRED	RESIDUAL OR KNOCKDOWN
s-Methoprene 0.05 % (w/w)	Pharaoh ant	In and around the Home, Food industry areas, Bakeries, Butcher's shops, Hotels, Hospitals, Restaurants and similar establishments.	1-2 bait stations / 5 sq/m (depending on level of infestation).	Ready-to-use - just cut off top on the dotted line and stick each station along Ant runs or near nests.	Wear suitable protective clothing and gloves.	Knockdown.

CIMETROL RFU

ACTIVE %	SPECIES EFFECTIVE AGAINST	AREA OF USE	DILUTION/DOSE RATES	APPLICATION TECHNIQUE	PPE REQUIRED	RESIDUAL OR KNOCKDOWN
Cypermethrin 0.1% (w/w) , Pyriproxyfen 0.01% (w/w), Chrysanthemum Cinerariaefolium 0.05% (w/w)	Ants, Beetles, Mites, Cockroaches, Fleas, Flies, Mosquitoes, Wasps, Moths and Bed bugs.	For use indoors on non-porous surfaces, crack and crevices, hard and soft furnishings, including mattresses and carpets, in hospitals (excl. occupied wards), offices, industrial premises, museums, aircraft, ships and military installations. For Outdoor use on Ant and Wasp nests.	Space Treatment- 1 ml of product per m ² as a fine mist - Surface Spray- apply 20 ml of product per m ² slightly wetting the surface to be protected - Repeat treatment as and when required .	Ready-to-use aerosol.	Full face mask or half mask with goggles, chemical-resistant gloves or coveralls.	Knockdown.

CIMETROL SUPER EW

ACTIVE %	SPECIES EFFECTIVE AGAINST	AREA OF USE	DILUTION/DOSE RATES	APPLICATION TECHNIQUE	PPE REQUIRED	RESIDUAL OR KNOCKDOWN
Cypermethrin 25% (w/w), Tetramethrin 10% (w/w), Piperonyl Butoxide 20% & Pyriproxyfen 1% (w/w) of insect growth regulator	Bed bugs, Fleas, Cockroaches, Beetles (inc. larvae), Flies, Mosquitoes, Moths (inc. larvae) and Wasps.	For use inside all domestic, commercial, and industrial premises, including Kitchens, Hotels, Dormitories (inc. sleeping areas), Hospitals (excl. occupied wards), Military establishments, Food storage (inc. Processing areas).	Crawling Pests (Routine Treatments): 25 ml of product to 5 L of water - Crawling Pests (Heavy infestations): 50 ml of product to 5 L of water - Flying Insects (Routine Treatments): 25 ml of product to 5 L of water - 1 L of ready-to-use solution treats 20 m ² .	Compression Sprayer, apply as a coarse, low-pressure spray.	Full face mask or half mask with goggles, chemical-resistant gloves or coveralls.	Excellent residual and knockdown with flushing effect, plus long period of control due to IGR.

COOPEX MAXI SMOKE GENERATORS

ACTIVE %	SPECIES EFFECTIVE AGAINST	AREA OF USE	DILUTION/DOSE RATES	APPLICATION TECHNIQUE	PPE REQUIRED	RESIDUAL OR KNOCKDOWN
Permethrin 13.35% (w/w)	Flying Insects: For the control of flying insects, e.g. Houseflies, Cluster flies, Mosquitoes, Fruit flies, Wasps and Moths - Crawling insects: Aids the control of crawling insects, e.g. Fleas, Bed bugs, Ants, Cockroaches and Stored product insects, e.g. Saw-toothed grain beetles and adult Grain weevils.	Food handling, Storage and Manufacture - Domestic: e.g. Private housing - Public Hygiene Areas: Hospitals (excl. occupied wards), Industrial & municipal buildings - Small Animal Housing: Zoos, Pet shops, Kennels, Veterinary practices, Laboratory animal houses (excl. pens and cages).	Flying Insects - 1 generator per 1000 cubic meters against Fleas and Bed bugs - 1 generator per 250 cubic meters against other crawling insects - 1 generator per 62.5 cubic meters.	Ready-to-use Smoke Generator - refer to product label before igniting the smoke generator.	Full face mask or half mask with goggles, chemical-resistant gloves or coveralls.	Rapid flushing agent, knockdown and kill.

COOPEX MINI SMOKE GENERATORS

ACTIVE %	SPECIES EFFECTIVE AGAINST	AREA OF USE	DILUTION/DOSE RATES	APPLICATION TECHNIQUE	PPE REQUIRED	RESIDUAL OR KNOCKDOWN
Permethrin 13.5% (w/w)	Flying Insects: For the control of flying insects, e.g. Houseflies, Cluster flies, Mosquitoes, Fruit flies, Wasps and Moths - Crawling insects: Aids the control of crawling insects, e.g. Fleas, Bed bugs, Ants, Cockroaches and Stored product insects, e.g. Saw-toothed grain beetles and adult Grain weevils.	Food handling, Storage and Manufacture - Domestic: e.g. Private housing - Public Hygiene Areas: Hospitals (excl. occupied wards), Industrial & municipal buildings - Small Animal Housing: Zoos, Pet shops, Kennels, Veterinary practices, Laboratory animal houses (excl. pens and cages).	Flying Insects - 1 generator per 120 cubic meters against Fleas and Bed bugs - 1 generator per 30 cubic meters against other crawling insects - 1 generator per 7.5 cubic meters (such as Ants and Cockroaches).	Ready-to-use Smoke Generator - refer to product label before igniting the smoke generator.	Full face mask or half mask with goggles, chemical-resistant gloves or coveralls.	A knockdown treatment only - Only insects present at the time of treatment are affected.

CYTROL FORTE 10 g SACHETS & 250 g JAR

ACTIVE %	SPECIES EFFECTIVE AGAINST	AREA OF USE	DILUTION/ DOSE RATES	APPLICATION TECHNIQUE	PPE REQUIRED	RESIDUAL OR KNOCKDOWN
Cypermethrin 40 % (w/w)	For use against Cockroaches, Fleas, Ants, Bed bugs, Silverfish, Woodlice, Earwigs, Millipedes, Centipedes, Houseflies, Clusterflies, Mosquitoes and Wasps.	In and Around Domestic and Industrial establishments, Hospitals (excl. occupied wards), Military areas, Restaurants and Eateries (not for use on Food preparation areas), Stores, Storage areas, Slaughterhouses, Refuse tips, Dustbins & around Manure heaps.	Crawling Insects (Routine Treatment): 10 g in 5 L of water (Heavy infestation): 20 g in 5 L of water Flying Insects 10 g in 5 L of water	Apply as a coarse, low-pressure spray.	Full face mask or half mask with goggles, chemical-resistant gloves or coveralls.	Good residual effect.

DEADLINE PYDUST

ACTIVE %	SPECIES EFFECTIVE AGAINST	AREA OF USE	DILUTION/ DOSE RATES	APPLICATION TECHNIQUE	PPE REQUIRED	RESIDUAL OR KNOCKDOWN
Pyrethrins & Pyrethroids & Chrysanthemum Cinerariaefolium, ext 0.11 % (w/w), Piperonyl Butoxide 0.495 % (w/w)	Flies, Mosquitoes, Cockroaches, Wasps, Silverfish, Fleas, Beetles, Woodlice, Carpet beetles, Moths and Spiders.	Public Hygiene and Domestic situations.	Refer to product label.	Bulb Duster or Dust Gun.	Full face mask with goggles and chemical-resistant gloves and coveralls.	Good Residual and knockdown effects.

DECIS

ACTIVE %	SPECIES EFFECTIVE AGAINST	AREA OF USE	DILUTION/ DOSE RATES	APPLICATION TECHNIQUE	PPE REQUIRED	RESIDUAL OR KNOCKDOWN
Deltamethrin 1.5 % (w/w)	Aphids, Caterpillars and other agricultural/ horticultural pests.	See label for details	See label for details	Apply using knapsack or compression sprayer.	Full face mask or half mask with goggles and chemical-resistant gloves and coveralls.	Residual.

DETHLAC INSECT LACQUER AEROSOL

ACTIVE %	SPECIES EFFECTIVE AGAINST	AREA OF USE	DILUTION/ DOSE RATES	APPLICATION TECHNIQUE	PPE REQUIRED	RESIDUAL OR KNOCKDOWN
Deltamethrin 0.02 % (w/w), Pyrethrins 0.08 % (w/w)	Ants, Cockroaches, Woodlice and other crawling insects.	For use Indoors and Out - Apply to any firm non-absorbent surface - See label for full details and precautions.	Ready-to-use aerosol.	Apply direct from aerosol in bands.	Full face mask or 1/2 mask with goggles, chemical-resistant gloves and coveralls.	Very residual as it dries to a hard clear film - Even after surfaces have been washed down, it is still effective.

INSECTRAC CL

ACTIVE %	SPECIES EFFECTIVE AGAINST	AREA OF USE	DILUTION/ DOSE RATES	APPLICATION TECHNIQUE	PPE REQUIRED	RESIDUAL OR KNOCKDOWN
13-Octadecadienal acetate 0.35 %	For the control of Clothes moths.	Protection of valuable fabrics from artifacts in Museums and Heritage homes to Clothing retailers and Home-owners.	Compressed inert powder containing synthetic Moth sex pheromones - Each tablet should be applied in a 5 m 'grid' pattern no higher than 2 m from the floor.	Used in conjunction with the dispenser.	Chemical-resistant gloves and coveralls.	A high-performance residual insecticide.

INSECTRAC SP

ACTIVE %	SPECIES EFFECTIVE AGAINST	AREA OF USE	DILUTION/ DOSE RATES	APPLICATION TECHNIQUE	PPE REQUIRED	RESIDUAL OR KNOCKDOWN
Tetradecadien-1-yl-Acetate 1 % (w/w)	For the control of Stored product moths.	Food factories, Mills, Industrial kitchens, Processing and Storage areas.	Compressed inert powder containing synthetic Moth sex pheromones - Each tablet should be applied in a 5 m 'grid' pattern.	Used in conjunction with the dispenser.	Chemical-resistant gloves and coveralls.	A high-performance residual insecticide.

FICAM D

ACTIVE %	SPECIES EFFECTIVE AGAINST	AREA OF USE	DILUTION/ DOSE RATES	APPLICATION TECHNIQUE	PPE REQUIRED	RESIDUAL OR KNOCKDOWN
Bendiocarb 1.25 % (w/w)	Ants, Wasps and Hornets (inc. Asian hornet).	Indoors use only, product may be applied to inside from the exterior.	Ready-to-use dust = 20-60 g depending on the size of the nest.	Apply by hand shaker, puffer, bellows or similar dust applicator.	Full face mask or 1/2 mask with goggles, chemical-resistant gloves and coveralls.	Fast knockdown as well as long residual activity.

FLYMAX G3

ACTIVE %	SPECIES EFFECTIVE AGAINST	AREA OF USE	DILUTION/ DOSE RATES	APPLICATION TECHNIQUE	PPE REQUIRED	RESIDUAL OR KNOCKDOWN
Aqueous Cellulose Polymer	Flies, Fleas, Mosquitoes and Bed bugs.	Indoor and outdoor use.	Ready-to-use formulation = 1 L covers 50 m ² .	Fine to Medium spray, at low pressure.	Full face mask or 1/2 mask with goggles, chemical-resistant gloves and coveralls.	Knockdown.

FORTEFOG JUMBO

ACTIVE %	SPECIES EFFECTIVE AGAINST	AREA OF USE	DILUTION/ DOSE RATES	APPLICATION TECHNIQUE	PPE REQUIRED	RESIDUAL OR KNOCKDOWN
Permethrin 13.25 % (w/w)	Houseflies, Clusterflies, Fruitflies, Mosquitoes, Wasps, Moths, Fleas, Bed bugs, Ants, Cockroaches and Stored product insects (inc. Saw-toothed grain beetle and adult Grain weevil).	For use in domestic situations, Public hygiene areas inc. hospitals (not occupied wards), industrial & municipal buildings & food handling/ storage premises. Also zoos, pet shops, kennels, veterinary practice & laboratory animal houses (ex. animal pens and cages). Not for use on grain or in empty grain stores.	Ready-to-use. Flying insects 1 generator = 4000 m ³ Crawling insects / fleas 1 generator = 1000 m ³ Ants / cockroaches 1 generator = 250 m ³	Refer to product label for before igniting the smoke generator.	Full face mask or 1/2 mask with goggles, chemical-resistant gloves and coveralls.	A knockdown treatment only, only insects present at the time of treatment will be affected.

FORMIDOR

ACTIVE %	SPECIES EFFECTIVE AGAINST	AREA OF USE	DILUTION/ DOSE RATES	APPLICATION TECHNIQUE	PPE REQUIRED	RESIDUAL OR KNOCKDOWN
Fipronil 0.0526 % (w/w)	Garden and Argentine ants.	In and around Domestic and Commercial buildings.	In and around domestic and commercial premises-up to 3 bait points (drops) every metre on the Ant trails.	Apply using a suitable bait gun or gel applicator.	Goggles, chemical-resistant gloves and coveralls.	Knockdown and residual effects.

GALLUP BIO AMENITY

ACTIVE %	SPECIES EFFECTIVE AGAINST	AREA OF USE	DILUTION/ DOSE RATES	APPLICATION TECHNIQUE	PPE REQUIRED	RESIDUAL OR KNOCKDOWN
Glyphosphate 30.7 % (w/w)	Broad leaf and Grass weeds.	Refer to product label.	Refer to product label.	Knapsac or Compression sprayer.	Goggles and chemical-resistant gloves and coveralls.	Residual.

GALLUP HOME & GARDEN

ACTIVE %	SPECIES EFFECTIVE AGAINST	AREA OF USE	DILUTION/ DOSE RATES	APPLICATION TECHNIQUE	PPE REQUIRED	RESIDUAL OR KNOCKDOWN
Glyphosate in a soluble concentrate (360 g/l)	Deep rooted Perennial weeds.	Home and Garden	24 ml to 1 L of water.	Knapsac or Compression sprayer.	Goggles and chemical-resistant gloves and coveralls.	Residual.

GALLUP XL

ACTIVE %	SPECIES EFFECTIVE AGAINST	AREA OF USE	DILUTION/DOSE RATES	APPLICATION TECHNIQUE	PPE REQUIRED	RESIDUAL OR KNOCKDOWN
Glyphosate in a soluble concentrate (360 g/l)	Deep rooted Perennial weeds.	Refer to product label.	Refer to product label.	Knapsac or Compression sprayer.	Goggles and chemical-resistant gloves and coveralls.	Residual.

GRAZON PRO

ACTIVE %	SPECIES EFFECTIVE AGAINST	AREA OF USE	DILUTION/DOSE RATES	APPLICATION TECHNIQUE	PPE REQUIRED	RESIDUAL OR KNOCKDOWN
Triclopyr (240 g/l) and Clopyralid (60 g/l)	Nettles, Docks thistles, Brambles, Broom and Gorse.	Established Grasslands.	6 ml per litre.	Knapsac or Compression sprayer.	Full face mask or 1/2 mask with goggles, chemical-resistant gloves and coveralls.	Knockdown.

GOLIATH GEL

ACTIVE %	SPECIES EFFECTIVE AGAINST	AREA OF USE	DILUTION/DOSE RATES	APPLICATION TECHNIQUE	PPE REQUIRED	RESIDUAL OR KNOCKDOWN
Fipronil 0.053 % (w/w)	German Cockroaches, Brown-banded cockroaches, Oriental cockroaches and American cockroaches	Refer to label.	Dependant on species please refer to product label.	Apply using a suitable bait gun / gel applicator.	The product is not classified on the basis of its toxicity but we would advise that you wear suitable disposable gloves and coveralls in the interest of good hygiene.	Effective long term control is maintained several weeks after initial treatment.

GRAIN-TECT ULV

ACTIVE %	SPECIES EFFECTIVE AGAINST	AREA OF USE	DILUTION/DOSE RATES	APPLICATION TECHNIQUE	PPE REQUIRED	RESIDUAL OR KNOCKDOWN
Deltamethrin (6 g/l) and Piperonyl Butoxide (54 g/l)	Crawling Insects: Grain weevils, Flour beetles, Grain borers, Saw-toothed grain beetles, Bean weevils - Flying Insects: Rice moths, Indian meal moths, Grain moths.	Applied directly to the grain.	Applied through most existing ULV applicators capable of dosing at 42 ml per tonne.	Applied with dosing atomiser pump calibrated to the flow of the grain.	When coming into contact with liquid chemicals: Full face mask or half mask with goggles, chemical-resistant gloves and coveralls.	Knockdown and residual (12-months protection).

HARMONIX POULTRY RED MITE

ACTIVE %	SPECIES EFFECTIVE AGAINST	AREA OF USE	DILUTION/ DOSE RATES	APPLICATION TECHNIQUE	PPE REQUIRED	RESIDUAL OR KNOCKDOWN
Aqueous Cellulose Polymer (contains Isopropanol)	Poultry red mite.	For use In and Around Avian housing - Apply directly to the Mites and the dusty areas and apply to run-off.	Dilute 1 L of product to 7.5 L of clean water - Apply about 8.5 litres per 200 sq/m.	A suitable mechanical, electrical or motorized sprayer capable of producing a coarse spray quality.	Wear face protection and gloves.	Knockdown, no residual activity.

INSECTABAN

ACTIVE %	SPECIES EFFECTIVE AGAINST	AREA OF USE	DILUTION/ DOSE RATES	APPLICATION TECHNIQUE	PPE REQUIRED	RESIDUAL OR KNOCKDOWN
Permethrin 0.23 % (w/w)	Fleas, Flies, Wasps, Moths, Bed bugs, Beetles and Booklice.	For use in Domestic and Commercial premises, Hospitals, Hotels, Food factories and other Industrial premises.	Ready-to-use product- For Fly control-spray 1 L of product per 100 sq/m, to control Flying insects and larvae, fog 1 L of product per 300 cubic metres.	Use a suitable hand or mechanical sprayer capable of a coarse spray or fogging machine - Use paintbrush or roller for localised treatments or where spray drift must be avoided.	Full face mask or 1/2 mask with goggles, chemical-resistant gloves and coveralls.	Some knockdown effects with excellent residual properties.

K-OBIOL EC25

ACTIVE %	SPECIES EFFECTIVE AGAINST	AREA OF USE	DILUTION/ DOSE RATES	APPLICATION TECHNIQUE	PPE REQUIRED	RESIDUAL OR KNOCKDOWN
Deltamethrin 2.5 % (w/w), Piperonyl Butoxide 22.5 % (w/w) and solvent Naptha	Stored product pest (inc. crawling insects such as Grain weevil, Flour beetle, Grain borer, Saw-toothed grain beetle and Bean weevil - Flying Insects such as Warehouse moth, Rice moth, Indian meal moth and Grain moth.	For use on Stored grain and pulses, Crop handling equipment and Storage structures.	Direct admixture: With grain-1 L to 100 tonnes of grain/ pulses - Crop handling equipment and storage structure-60 ml per 100 m ² - Maximum number of treatments: Crop handling equipment and storage structure-one per annum - Complete admixture for grains, pulses-one per batch.	A suitable hand or mechanical compression sprayer.	Full face mask or 1/2 mask with goggles, chemical-resistant gloves and coveralls.	Residual.

K-OTHRINE PARTIX

ACTIVE %	SPECIES EFFECTIVE AGAINST	AREA OF USE	DILUTION/ DOSE RATES	APPLICATION TECHNIQUE	PPE REQUIRED	RESIDUAL OR KNOCKDOWN
Deltamethrin 2.49 % (w/w)	To control crawling insects (inc. Cockroaches and Bed bugs), Houseflies at rest and Spiders also for the outdoor control of Wasps in free-hanging nests.	Indoors - in public places (e.g. schools, hospitals), Domestic, Commercial and Industrial premises to control Crawling insects (inc. Bed bugs, Cockroaches), Houseflies at rest & Spiders. K-Othrine Partix can be used outdoors to control wasps in free hanging nests.	Species dependant - refer to product label.	A suitable hand or mechanical sprayer capable of a coarse spray.	Full face mask or 1/2 mask with goggles, chemical-resistant gloves and coveralls.	Knockdown and residual.

LIGNUM INSECTICIDE PRO 162.5

ACTIVE %	SPECIES EFFECTIVE AGAINST	AREA OF USE	DILUTION/DOSE RATES	APPLICATION TECHNIQUE	PPE REQUIRED	RESIDUAL OR KNOCKDOWN
Permethrin (62.5 g/L) and Alcohols (C9-11) ethoxylated.	Woodworm and Wood boring insects (inc. House longhorn beetle, Common furniture beetle and Termites).	Spray directly to affected timber.	1 L of product with 24 L of water. Curative - apply at a rate of 300 ml/m ² (1 L per 3.3 m ²) Preventative - Apply at a rate of 200 ml/m ² (1 L per 5 m ²)	Apply by brush or low-pressure spray.	Full face mask or 1/2 mask with goggles, chemical-resistant gloves and coveralls.	Knockdown and residual.

LIGNUM PRO D156

ACTIVE %	SPECIES EFFECTIVE AGAINST	AREA OF USE	DILUTION/DOSE RATES	APPLICATION TECHNIQUE	PPE REQUIRED	RESIDUAL OR KNOCKDOWN
Propiconazole 93.75 g/L, IPBC 31.25 g/L and alcohols (C9-11) ethoxylated. Permethrin 31.25 g/l	Woodworm and Wood rotting fungi (inc. White and Brown rot, Blue stain, House longhorn beetle, Common furniture beetle and termites).	Apply directly to the affected timber.	Refer to product label.	Apply with any suitable hand or mechanical sprayer capable of producing a coarse spray.	Full face mask or 1/2 mask with goggles, chemical-resistant gloves and coveralls.	Knockdown and residual.

MAXFORCE PLATIN

ACTIVE %	SPECIES EFFECTIVE AGAINST	AREA OF USE	DILUTION/DOSE RATES	APPLICATION TECHNIQUE	PPE REQUIRED	RESIDUAL OR KNOCKDOWN
Clothianidin 1 %	Cockroaches and Silverfish.	Indoors Domestic, Food handling/storage, Public buildings, Small animal houses.	Species dependant - refer to product label.	Apply using a bait gun.	Wear gloves to avoid contact.	Knockdown and residual.

MAXFORCE PUSHBOX

ACTIVE %	SPECIES EFFECTIVE AGAINST	AREA OF USE	DILUTION/DOSE RATES	APPLICATION TECHNIQUE	PPE REQUIRED	RESIDUAL OR KNOCKDOWN
Imidacloprid 0.03 %	Black garden ant, Argentine ant, Pharaoh ant (Indoor Only) Ghost ant (Indoor Only).	Indoors: Industrial/commercial premises, Households/private areas, Kitchens, Living rooms and cellars, Public areas (e.g. hospitals and nursing homes) - Outdoors: Terraces, Pavements, Patios, Entrances to sheds/garages and Public areas (e.g. Hospitals and Nursing homes).	1 bait station per Ants nest - Maximum 2 bait stations per location or Ant trail.	Ready-to-use Bait Station - Bait stations should not be replaced more than every 12 weeks.	Wear gloves to avoid contact.	Knockdown and residual.

MAXFORCE QUANTUM

ACTIVE %	SPECIES EFFECTIVE AGAINST	AREA OF USE	DILUTION/DOSE RATES	APPLICATION TECHNIQUE	PPE REQUIRED	RESIDUAL OR KNOCKDOWN
Imidacloprid 0.03 %	Garden ant, Argentine ant, Pharaoh ant and Ghost ant.	Indoor: Industrial/commercial premises, Households/private areas, Kitchens, Living rooms and Cellars, Public areas (Hospitals and Nursing homes) Outdoors: Terraces, Pavements, Patios, Entrances to sheds/garages and Public areas (Hospitals and Nursing homes. Not for use on soils, lawns or flower beds.	Small drops of bait about 1 cm diameter (200 mg) each - 1 spot of 200 mg per sq/m treat area or 1 spot 200 mg per linear meter of Ant trail.	Apply using a suitable bait gun or gel applicator.	Googles, chemical-resistant gloves and coveralls.	Knockdown and residual.

MITEMAX READY-TO-USE

ACTIVE %	SPECIES EFFECTIVE AGAINST	AREA OF USE	DILUTION/DOSE RATES	APPLICATION TECHNIQUE	PPE REQUIRED	RESIDUAL OR KNOCKDOWN
Aqueous Cellulose polymer (contains Isopropanol)	Poultry red mite.	Apply to the structure and surfaces of Poultry shed inc. dusty areas where Mites are harbouring.	Ready-to-use. Apply to run off	Supplied in ready-to-use trigger pack.	Wear face protection and gloves.	Immobilisation and knockdown.

NEPOREX

ACTIVE %	SPECIES EFFECTIVE AGAINST	AREA OF USE	DILUTION/DOSE RATES	APPLICATION TECHNIQUE	PPE REQUIRED	RESIDUAL OR KNOCKDOWN
Cyromazine 50 % (w/w)	Housefly larvae.	Pig, Poultry and Calf units, Manure heaps, Landfill sites and Waste management.	1 g of product to 5 L of water	Refer to product label.	Full face mask or 1/2 mask with goggles, chemical-resistant gloves and coveralls.	Residual.

OA2KI CONCENTRATE & OA2KI READY-TO-USE

ACTIVE %	SPECIES EFFECTIVE AGAINST	AREA OF USE	DILUTION/DOSE RATES	APPLICATION TECHNIQUE	PPE REQUIRED	RESIDUAL OR KNOCKDOWN
Aqueous cellulose polymer	Ants, Bed bugs, Fleas, Flies and small insects.	Refer to product label.	Concentrate only: 1 part concentrate to 7.5 parts water - 500 ml of Concentrate makes 4.25 litres of ready-to-use product.	As a surface spray-use a knapsack / compression sprayer-apply as a medium spray - As a space spray-apply through a suitable ULV or fogging equipment that can dispense water-based products.	Wear face protection and gloves.	Knockdown.

OA2KI POWDER

ACTIVE %	SPECIES EFFECTIVE AGAINST	AREA OF USE	DILUTION/DOSE RATES	APPLICATION TECHNIQUE	PPE REQUIRED	RESIDUAL OR KNOCKDOWN
Diatomaceous Earth	Effective in desiccating areas where applied.	Domestic, Commercial, Public and Institutional premises, inc. Kitchens and Food preparation/manufacturing areas.	For public health pest-apply as required to cracks and crevices 10-30 g per m ² .	Apply using a suitable mechanical or electric dust applicator or via a puffer pack.	1/2 mask with goggles, chemical-resistant gloves and coveralls.	Extremely residual. If product is applied to dry, clean and undisturbed environments.

OA2KI AEROSOL - SD

ACTIVE %	SPECIES EFFECTIVE AGAINST	AREA OF USE	DILUTION/DOSE RATES	APPLICATION TECHNIQUE	PPE REQUIRED	RESIDUAL OR KNOCKDOWN
Silicon Dioxide	Bed bugs.	Domestic and Commercial - cracks and crevices.	Ready-to-use. Apply liberally.	Apply directly from aerosol hold 30 cm away from surface - One can covers 9 m ² .	1/2 mask with goggles, chemical-resistant gloves and coveralls.	Residual.

OA2KI AEROSOL - OP

ACTIVE %	SPECIES EFFECTIVE AGAINST	AREA OF USE	DILUTION/DOSE RATES	APPLICATION TECHNIQUE	PPE REQUIRED	RESIDUAL OR KNOCKDOWN
Synthetic Organic Polymer	Ants, Bed bugs, Fleas, Flies and small insects.	Domestic and Commercial - cracks and crevices.	Ready-to-use. Apply liberally.	Apply directly from aerosol hold 30 cm away from surface - One can covers 9 m ² .	1/2 mask with goggles, chemical-resistant gloves and coveralls.	Residual.

PERMOST UNIFLY

ACTIVE %	SPECIES EFFECTIVE AGAINST	AREA OF USE	DILUTION/DOSE RATES	APPLICATION TECHNIQUE	PPE REQUIRED	RESIDUAL OR KNOCKDOWN
Permethrin 0.31 % (w/w) Tetramethrin 0.124 % (w/w)	Flies, Mosquitoes, Wasps, Ants, Cockroaches, Earwigs, Fleas, Bristletails, Beetles, Mites, Ticks and Fleas.	Hospitals (excl. occupied wards), Military barracks, Milk rooms, Avian housing and Refuse tips.	1 L of product sufficient to treat 1,000 m ² .	Hand Sprayer or Fogger.	1/2 mask with goggles, chemical-resistant gloves and coveralls.	Knockdown.

PREVENT SPRAY						
ACTIVE %	SPECIES EFFECTIVE AGAINST	AREA OF USE	DILUTION/ DOSE RATES	APPLICATION TECHNIQUE	PPE REQUIRED	RESIDUAL OR KNOCKDOWN
Pyrethrins 1 % (w/w) synergised by Piperonyl Butoxide.	Repels and kills, Mosquitoes, Fleas, Sandflies, Gnats and Midges.	Can be used pretty much anywhere but do not spray directly on to food.	Use as necessary- press once to release a 50 mg of spray.	Ready-to-use aerosol.	Do not spray near eyes, the product can be applied directly to skin to act as a repellent.	Knockdown, protection last for 6 hours.

PROTECTOR ONE SHOT						
ACTIVE %	SPECIES EFFECTIVE AGAINST	AREA OF USE	DILUTION/ DOSE RATES	APPLICATION TECHNIQUE	PPE REQUIRED	RESIDUAL OR KNOCKDOWN
Pyrethrins 0.2 % (w/w)	For the control of flying insects such as Flies, Mosquitoes, Ants, Cockroaches, Wasps, Earwigs, Silverfish (inc. other bristletails), Fleas, Beetles, Bed bugs, Moths, Booklice, Mites (inc. Dust mites).	Use in domestic & commercial situations, inc. kitchens, hospitals (not occupied wards), hotels, restaurants, public & municipal buildings & onboard ships, for use outdoors on patios, paths amenity areas, transit stations, refuse tips & wasp nests. In & around farm buildings.	Ready-to-use aerosol.	Ready-to-use aerosol.	Full face or 1/2 mask with goggles. chemical-resistant gloves and coveralls.	Knockdown.

PROTECTOR NATURAL						
ACTIVE %	SPECIES EFFECTIVE AGAINST	AREA OF USE	DILUTION/ DOSE RATES	APPLICATION TECHNIQUE	PPE REQUIRED	RESIDUAL OR KNOCKDOWN
Pyrethrins 0.2 % (w/w)	Flies, Mosquitos, Ants, Cockroaches, Wasps, Earwigs, Silverfish (inc. other bristletails), Fleas, Beetles, Bed bugs, Moths, Booklice, Mites (inc. Dust mites) - For use against Poultry red mite and Litter beetles.	Use in domestic & commercial situations, inc. kitchens, hospitals (not occupied wards), hotels, restaurants, public & municipal buildings & onboard ships, for use outdoors on patios, paths amenity areas, transit stations, refuse tips & wasp nests. In & around farm buildings.	Space spray: 5-10 second burst will treat an average sized room 30 sq/m - refer to product label for directions on use.	Ready-to-use aerosol.	Avoid breathing in the aerosol, wear suitable gloves.	Knockdown

PYBUTHRIN 33						
ACTIVE %	SPECIES EFFECTIVE AGAINST	AREA OF USE	DILUTION/ DOSE RATES	APPLICATION TECHNIQUE	PPE REQUIRED	RESIDUAL OR KNOCKDOWN
Chrysanthemum Cinerariaefolium Extract 0.37 % (w/w), Piperonyl Butoxide and Distillates (petroleum), hydrotreated light.	For the control of: Flying Insects, e.g. Flies, Wasps (inc. Wasps nests), and Stored product moths and Mosquitoes - Crawling Insects, e.g. Cockroaches and Stored product insects.	Refer to product label.	Space spray: Indoors: 1 litre of product per 3000 m ³ . Outdoors: Up to 25 litres per ha / 1 litre per 2000 m ² . Surface (contact) spray: 5 litres of product per 100 m ²	Apply with any suitable hand, mechanically or electrically operated sprayer capable of producing a fine mist or fog.	Full face or 1/2 mask with goggles, chemical-resistant gloves and coveralls.	Rapid knockdown and kill. No residual activity.

RESIDEX P

ACTIVE %	SPECIES EFFECTIVE AGAINST	AREA OF USE	DILUTION/DOSE RATES	APPLICATION TECHNIQUE	PPE REQUIRED	RESIDUAL OR KNOCKDOWN
Permethrin 0.5 % (w/w)	Ants, Wasps, Fleas and Lice inc. crack and crevice treatments where insects settle.	Apply dust In and Around insect hiding places paying particular attention to cracks and crevices.	Apply 10-25 g per sq/m.	Apply by hand shaker, puffer, bellows or similar dust applicator.	Full face mask or 1/2 mask with goggles, chemical-resistant gloves and coveralls.	Residual.

SIRIUS

ACTIVE %	SPECIES EFFECTIVE AGAINST	AREA OF USE	DILUTION/DOSE RATES	APPLICATION TECHNIQUE	PPE REQUIRED	RESIDUAL OR KNOCKDOWN
Tetraethylortho-silicate	Crop protection product - check label for direction on use for more information.	Field crops, Fruit crops, Ornamental/ Sports & Turf inc. in Ferigation lines.	Refer to product label.	Suitable for crop and turf sprayers, apply to drench.	Full face mask or 1/2 mask with goggles, chemical-resistant gloves and coveralls.	Knockdown.

VULCAN P5

ACTIVE %	SPECIES EFFECTIVE AGAINST	AREA OF USE	DILUTION/DOSE RATES	APPLICATION TECHNIQUE	PPE REQUIRED	RESIDUAL OR KNOCKDOWN
Permethrin 0.05 % (w/w)	Fleas, Lice, Mites, Ticks, Cockroaches, Earwigs, Beetles (inc. larvae), Moths (inc. larvae), Bed bugs, Ants, Woodlice, Silverfish and Wasps.	In and Around buildings.	10-25 g per m ² .	Dusting applicator.	Full face mask or 1/2 mask with goggles, chemical-resistant gloves and coveralls.	Residual and knockdown.

WASP NEST DESTROYER FOAM

ACTIVE %	SPECIES EFFECTIVE AGAINST	AREA OF USE	DILUTION/DOSE RATES	APPLICATION TECHNIQUE	PPE REQUIRED	RESIDUAL OR KNOCKDOWN
Tetramethrin 0.3 % (w/w) and d-Phenothrin 0.097 % (w/w)	Wasps	Apply Direct to Wasp nest-do not apply product to Wasp nests in ground.	An 8-second burst will cover a nest with a diameter of 50 cm - A 12-second burst will cover a nest with a diameter of 80 cm - To be effective the nest must be completely covered in foam.	Stand at least 2 m away from nest, holding can upright as possible, spray foam towards the nest - refer to product label for more direction on use.	Minimise operator exposure - Eye protection and gloves.	Knockdown.

XLARV						
ACTIVE %	SPECIES EFFECTIVE AGAINST	AREA OF USE	DILUTION/DOSE RATES	APPLICATION TECHNIQUE	PPE REQUIRED	RESIDUAL OR KNOCKDOWN
A unique silicone based liquid for Mosquito, Larvae and Pupae control.	Can be used on all mosquito species: the film prevents pupae and larvae from attaching themselves at the surface while attempting to breathe, thereby causing them to drown.	For use on Open water bodies and Underground systems.	Refer to product label.	Refer to product label.	Refer to product label.	Refer to product label.

WATER VOLE PROTECTION



KNOW YOUR VOLE

Water voles are easily confused with rats. Rats are treated as pests but water voles are a legally protected species. How can pest control affect water voles? Controlling pests such as rats may lead to accidental destruction of water vole colonies. Damage occurs when water voles are mistaken for rats, or when control methods are used carelessly. Rats sometimes prey on young water voles so careful rat control can benefit water vole colonies.

WHAT THE LAW SAYS

Is it an offence to intentionally or recklessly damage, destroy or obstruct access to any structure or place that a water vole uses for shelter or protection. It is also an offence to disturb a water vole while it is using such a place. (Wildlife and Countryside Act 1981, Schedule 5, Section 9[4]). Blocking water vole burrows is illegal. Placing traps or bait boxes into or in the way of water vole burrows could lead to prosecution. Offences carry a maximum penalty of £5000. The court may also take any vehicle or other equipment used to commit the offence.

THREATS TO WATER VOLES

Water voles have suffered the most dramatic decline of any British mammal in the last century. There is now only one vole for every 20 that were alive in 1900. The main causes for this decline have been loss and damage to habitat, and predation by American mink. Any activity that poses the slightest threat to water voles must therefore be undertaken with extreme care.

THREATS TO WATER VOLES

If you are controlling pests near water, check for signs of water voles before starting. Your local Wildlife Trust may be able to provide information on water vole presence at the site. Both water voles and rats burrow into the banks of most types of waterway. Water voles are usually restricted to within several meters of the water's edge. Use the chart below to check for signs of water voles. If you find water voles and rats follow the advice in the leaflet. If in doubt, contact your local Wildlife Trust.

WATER VOLE (*Arvicola terrestris*)

SIZE & SHAPE	Water voles have rounded bodies and grow to 320 g, smaller than an adult male rat.
COLOUR	Water voles are generally mid-brown in colour with silky fur. Dark brown or black individuals may occur, especially in uplands.
SNOUT, EARS AND TAIL	Water voles have short blunt snouts. Their ears are almost hidden by fur. Their furry tail is two thirds of their body length.
BURROWS	Water voles have short blunt snouts. Their ears are almost hidden by fur. Their furry tail is two thirds of their body length.
PATHS	Usually one main track along water's edge, with some paths pushing up into vegetation higher up the bank. Paths are normally concealed in grass and stay near the water.
DROPPINGS	Between spring and autumn droppings are left in piles of 5-100 usually within 30 cm of water. In winter droppings are dispersed. Droppings are 5-10 mm long and rounded at both ends. They have a putty-like texture, with very fine plant material visible. Green, brown, purplish or black in colour. No strong odour.
FEEDING REMAINS	The diet of water voles is mainly vegetarian. Water voles leave small piles of chopped vegetation (approx. 10cm long and cut at 45 degree angle with grooved teeth-marks at ends) at feeding sites on banks.
ACTIVITY	Can be active during the day but more likely to be seen at dawn and dusk.
FOOTPRINTS	Not a reliable guide.

BROWN RAT (*Rattus norvegicus*)

SIZE & SHAPE	Rats are bigger than water voles. Adult males weigh up to 500 g.
COLOUR	Grey or brown with a paler underside.
SNOUT, EARS AND TAIL	8-10 cm diameter burrows may occur well away from the water's edge often with a heap of soil in a 'fan' shape outside the entrance.
BURROWS	A network of well trampled paths connecting all burrows. Paths may lead across open land away from the water.
PATHS	A network of well trampled paths connecting all burrows. Paths may lead across open land away from the water.
DROPPINGS	One or several left on paths or at the water's edge. Droppings are 12-15 mm long, flat at one end and pointed at the other. Slimy or very soft texture, occasionally granular. Light brown to black in colour. Unpleasant odour of urine or ammonia.
FEEDING REMAINS	Rats are opportunist feeders and will eat a variety of foods. Remains of meals such as broken snail shells are sometimes found on the riverbank.
ACTIVITY	Largely nocturnal.
FOOTPRINTS	Not a reliable guide.



A-Z RODENT control

PRODUCTS 

The following charts have been produced only as an aid in product selection and to summarise some key points. Before using any of the rodenticides listed, a thorough site inspection and plan should be carried out. In all circumstances you should always read the product label. The information given in the table is to the best of our knowledge and is given in good faith at the time of print. We cannot accept any responsibility for loss or damage arising from any error or omission. You should always refer to the product SDS and label before use. Refer to the CRRU code for the Best Practice Guidelines.

CONTRAC BLOX				UK AUTHORISATION NUMBER UK-2015-0941		
ACTIVE % & TYPE	AREA OF USE	EFFECTIVE AGAINST	DOSAGE / QUANTITY GUIDE	PERMANENT BAITING APPROVED	BURROW BAITING APPROVED	PULSED BAITING APPROVED
Bromadiolone 0.005% (w/w)	Indoors and outdoors (around buildings), open areas and waste dumps.	Rats and Mice	Rats: Up to 225 g of bait per baiting point at 5 to 10 metre intervals. Mice: 6-28g Per baiting point every at 2-4 metres apart. Bait may be applied directly into burrows	Yes	Yes	No

CONTRAC PLACE PACKS				UK AUTHORISATION NUMBER UK-2015-0919		
ACTIVE % & TYPE	AREA OF USE	EFFECTIVE AGAINST	DOSAGE / QUANTITY GUIDE	PERMANENT BAITING APPROVED	BURROW BAITING APPROVED	PULSED BAITING APPROVED
Bromadiolone 0.005% (w/w)	Indoors and outdoors around buildings, open areas and waste dumps.	Rats and Mice	Rats: Place one to five place packs in a bait station or covered bait point. Place at 5 to 10 metre intervals. Mice: Place one pack in a bait station or covered bait point. Place at 5 to 10 metre intervals.	No	No	No

CONTRAC SUPER BLOX				UK AUTHORISATION NUMBER UK-2015-0941		
ACTIVE % & TYPE	AREA OF USE	EFFECTIVE AGAINST	DOSAGE / QUANTITY GUIDE	PERMANENT BAITING APPROVED	BURROW BAITING APPROVED	PULSED BAITING APPROVED
Bromadiolone 0.005% (w/w)	In and around buildings, open areas and waste dumps and sewers.	Rats	Rats: Place one 225 g block in a bait station/ bait point and place at 5 to 10 metre intervals. Rats in Sewers: Place one 225 g block at placement sites.	Yes	No	No

DEADLINE ALPHA EXPRESS				UK AUTHORISATION NUMBER UK-2013-0803		
ACTIVE % & TYPE	AREA OF USE	EFFECTIVE AGAINST	DOSAGE / QUANTITY GUIDE	PERMANENT BAITING APPROVED	BURROW BAITING APPROVED	PULSED BAITING APPROVED
Alphachloralose 4 % (w/w)	Indoors only.	Mice	Load each bait station with one or two 5 g blocks up to a maximum bait point size of 10 g. Bait stations are manually placed in the rodent infested area, in covered and protected positions at distances of no more than 3 metres apart.	No	No	No

DEADLINE BROMADIOLONE WHOLE WHEAT

UK AUTHORISATION NUMBER
UK-2014-0827

ACTIVE % & TYPE	AREA OF USE	EFFECTIVE AGAINST	DOSAGE / QUANTITY GUIDE	PERMANENT BAITING APPROVED	BURROW BAITING APPROVED	PULSED BAITING APPROVED
Bromadiolone 0.005 % (w/w)	Indoors and outdoors (around buildings), outdoor open areas and sewers.	Rats and Mice	Rats: Secure up to 250 g of product in a covered tamper resistant baiting stations or covered bait points spaced 10 m apart (5 m apart in areas of high infestation) Sewers: Up to 300 g per manhole. Mice: Secure 50 g of product in a covered tamper resistant baiting stations or covered bait points spaced 10 metres apart (5 m apart in areas of high infestations).	Yes	Yes	No

DEADLINE BROMADIOLONE PASTE

UK AUTHORISATION NUMBER
UK-2013-0750

ACTIVE % & TYPE	AREA OF USE	EFFECTIVE AGAINST	DOSAGE / QUANTITY GUIDE	PERMANENT BAITING APPROVED	BURROW BAITING APPROVED	PULSED BAITING APPROVED
Bromadiolone 0.005 % (w/w)	Indoors and Outdoors (around buildings).	Mice	Secure 5 g of bait into both corners place bait points 10 metres apart for low infestations, reducing to 5 metres in areas of high infestations.	Yes	No	No

DEADLINE DIFENACOU M PASTE

UK AUTHORISATION NUMBER
UK-2011-0148

ACTIVE % & TYPE	AREA OF USE	EFFECTIVE AGAINST	DOSAGE / QUANTITY GUIDE	PERMANENT BAITING APPROVED	BURROW BAITING APPROVED	PULSED BAITING APPROVED
Difenacoum 0.005 % (w/w)	Indoors and outdoors (around buildings).	House Mice (<i>Mus musculus</i>)	Secure up to 8 g of product in covered tamper resistant baiting stations or covered bait points spaced 10 m apart (5 m apart in high infestation areas) in areas where mice are active.	Yes	No	No

DEADLINE DIFENACOU M WHOLE WHEAT

UK AUTHORISATION NUMBER
UK-2012-0591

ACTIVE % & TYPE	AREA OF USE	EFFECTIVE AGAINST	DOSAGE / QUANTITY GUIDE	PERMANENT BAITING APPROVED	BURROW BAITING APPROVED	PULSED BAITING APPROVED
Difenacoum 0.005 % (w/w)	Indoors and outdoors around buildings, in sewers and outdoor open areas.	Rats and Mice	Mice: (<i>Mus musculus</i>): Secure up to 50 g of product in covered tamper resistant baiting stations or covered bait points spaced 10 m apart (5 m apart in high infestation areas). Rats: Secure up to 200 g of product in covered tamper resistant baiting stations or covered bait points spaced 10m apart (5 m apart in areas of high infestation) in areas where rats are active.	Yes	Yes	No

DEADLINE NON-TOX INDICATOR PASTE				UK AUTHORISATION NUMBER N/A		
ACTIVE % & TYPE	AREA OF USE	EFFECTIVE AGAINST	DOSAGE / QUANTITY GUIDE	PERMANENT BAITING APPROVED	BURROW BAITING APPROVED	PULSED BAITING APPROVED
Non Toxic	Indoor and outdoors.	Rats and Mice	Apply 3-4 g of non toxic indicator paste from a caulking gun to tamper resistant bait boxes.	N/A	N/A	N/A

DEADLINE MOUSE BLOCKS				UK AUTHORISATION NUMBER UK-2014-0811		
ACTIVE % & TYPE	AREA OF USE	EFFECTIVE AGAINST	DOSAGE / QUANTITY GUIDE	PERMANENT BAITING APPROVED	BURROW BAITING APPROVED	PULSED BAITING APPROVED
Bromadiolone 0.005 % (w/w)	Indoors and Outdoors (around buildings).	Mice	Secure up to 20 g of product in covered tamper resistant baiting stations or covered bait points spaced 10 m apart (5 m apart in high infestation areas).	Yes	No	No

DEADLINE RAT BAIT BLOCKS				UK AUTHORISATION NUMBER UK-2014-0812		
ACTIVE % & TYPE	AREA OF USE	EFFECTIVE AGAINST	DOSAGE / QUANTITY GUIDE	PERMANENT BAITING APPROVED	BURROW BAITING APPROVED	PULSED BAITING APPROVED
Bromadiolone 0.005 % (w/w)	Indoors and Outdoors (around buildings) and in Sewers.	Rats	Secure up to 240 g of product in a covered tamper resistant bait station or point every 10 m (5 m apart in areas of high infestation).	Yes	No	No

DEADLINE TRACKING GEL				UK AUTHORISATION NUMBER N/A		
ACTIVE % & TYPE	AREA OF USE	EFFECTIVE AGAINST	DOSAGE / QUANTITY GUIDE	PERMANENT BAITING APPROVED	BURROW BAITING APPROVED	PULSED BAITING APPROVED
Non-Toxic	Indoor and outdoors.	Rats and Mice	Use as necessary.	N/A	N/A	N/A

DETEX BLOX WITH BIOMARKER

UK AUTHORISATION NUMBER
N/A

ACTIVE % & TYPE	AREA OF USE	EFFECTIVE AGAINST	DOSAGE / QUANTITY GUIDE	PERMANENT BAITING APPROVED	BURROW BAITING APPROVED	PULSED BAITING APPROVED
Non Toxic	In and outdoors.	Rats and Mice	Rats: 3-6 Detex blox every 9-15 metres (30 to 50 Feet). Mice: 1-2 Detex blox every 2-4 Metres (6 to 14 Feet).	N/A	N/A	N/A

DETEX SOFT BAIT WITH LUMITRACK

UK AUTHORISATION NUMBER
N/A

ACTIVE % & TYPE	AREA OF USE	EFFECTIVE AGAINST	DOSAGE / QUANTITY GUIDE	PERMANENT BAITING APPROVED	BURROW BAITING APPROVED	PULSED BAITING APPROVED
Non Toxic	Indoors and Outdoors.	Rats and Mice	Rats: Place 3-6 Detex Soft bait sachets every 4-9 m (15-30 ft). Mice: Place 1-2 Detex Soft bait sachets every 2-4 m (8-12 ft).	N/A	N/A	N/A

HARMONIX MONITORING PASTE

UK AUTHORISATION NUMBER
N/A

ACTIVE % & TYPE	AREA OF USE	EFFECTIVE AGAINST	DOSAGE / QUANTITY GUIDE	PERMANENT BAITING APPROVED	BURROW BAITING APPROVED	PULSED BAITING APPROVED
Non Toxic	Indoors and Outdoors.	Rats and Mice	Rats: 2-4 sachets of Harmonix Monitoring every 5-10 m Traps (Rats) : 1 sachet per trap. Mice: 1-2 sachets of Harmonix Monitoring every 3-5 m.	N/A	N/A	N/A

KNOCKOUT D BLOCK

UK AUTHORISATION NUMBER
UK-2016-0994-0005

ACTIVE % & TYPE	AREA OF USE	EFFECTIVE AGAINST	DOSAGE / QUANTITY GUIDE	PERMANENT BAITING APPROVED	BURROW BAITING APPROVED	PULSED BAITING APPROVED
Difenacoum 0.0025 % (w/w)	Indoors and around buildings.	Rats and Mice	Rats: 3-5 blocks every 10 m and reducing to 5 m for heavy infestations. Mice: 1 block every 5 m reducing to 2 m for heavy infestations.	No	No	No

KNOCKOUT D PASTA SACHET				UK AUTHORISATION NUMBER UK-2013-0722		
ACTIVE % & TYPE	AREA OF USE	EFFECTIVE AGAINST	DOSAGE / QUANTITY GUIDE	PERMANENT BAITING APPROVED	BURROW BAITING APPROVED	PULSED BAITING APPROVED
Difenacoum 0.0029 % (w/w)	Indoors and around buildings.	Rats and Mice	Mice: 50 g per bait point every 5 m reducing to 2 m fro heavy infestations. Rats: 100 g per bait point every 10 m reducing to 5 m for heavy infestations.	No	No	No

KNOCKOUT WHEAT SACHET				UK AUTHORISATION NUMBER UK-2015-0895-0003		
ACTIVE % & TYPE	AREA OF USE	EFFECTIVE AGAINST	DOSAGE / QUANTITY GUIDE	PERMANENT BAITING APPROVED	BURROW BAITING APPROVED	PULSED BAITING APPROVED
Brodifacoum 0.0029 % (w/w)	Indoors and around buildings.	Rats and Mice	Mice: 50g per bait points every 5 m reducing to 2 m for heavy infestations. Rats: 200 g of bait every 10 m reducing to 5m for heavy infestations.	No	No	No

NEOSOREXA BAIT BLOCKS				UK AUTHORISATION NUMBER UK-2012-0360		
ACTIVE % & TYPE	AREA OF USE	EFFECTIVE AGAINST	DOSAGE / QUANTITY GUIDE	PERMANENT BAITING APPROVED	BURROW BAITING APPROVED	PULSED BAITING APPROVED
Difenacoum 0.005 % (w/w)	Indoors and around buildings, outdoors in open areas and outdoors in waste dumps & sewers.	Rats and Mice	Mice: 30 g per bait point every 5 m reducing to 2 m for heavy infestations. Rats: 200 g per bait point 10 m apart .	Yes	Yes	No

NEOSOREXA GOLD				UK AUTHORISATION NUMBER UK-2012-0304		
ACTIVE % & TYPE	AREA OF USE	EFFECTIVE AGAINST	DOSAGE / QUANTITY GUIDE	PERMANENT BAITING APPROVED	BURROW BAITING APPROVED	PULSED BAITING APPROVED
Difenacoum 0.005 % (w/w)	In and around buildings, outdoors in open areas, outdoors in waste dumps and in sewers.	House mice (<i>Mus musculus</i>), Brown rats (<i>Rattus norvegicus</i>) and Black rats (<i>Rattus Rattus</i>)	Mice: In and around buildings. Up to 30 g of bait placed 1-2 metres apart. Frequently over first 10-days and regularly as consumption continues. Rats: In and around buildings, outdoors in open areas and waste dumps. Up to 200 g of bait placed 10 metres apart. Frequently over first 10-days and regularly as consumption continues. In burrows: Up to 200 g of bait per burrow. In sewers: Up to 200 g of bait per manhole.	No	Yes	No

NEOSOREXA GOLD RAT PACKS

UK AUTHORISATION NUMBER
UK-2012-0304-0001

ACTIVE % & TYPE	AREA OF USE	EFFECTIVE AGAINST	DOSAGE / QUANTITY GUIDE	PERMANENT BAITING APPROVED	BURROW BAITING APPROVED	PULSED BAITING APPROVED
Difenacoum 0.005 % (w/w)	Indoors and around buildings, outdoors in open areas and waste dumps, burrows & sewers.	Rats and Mice	Mice: Up to 30 g of bait per bait point placed 1-2 metres apart. Rats: Up to 200 g of bait per bait point, placed 10 metres apart or 200 g per Burrow.	No	Yes	No

RACUMIN FOAM

UK AUTHORISATION NUMBER
UK-2014-0860

ACTIVE % & TYPE	AREA OF USE	EFFECTIVE AGAINST	DOSAGE / QUANTITY GUIDE	PERMANENT BAITING APPROVED	BURROW BAITING APPROVED	PULSED BAITING APPROVED
Coumatetralyl 0.4 % (w/w)	Indoors only.	Rats and Mice	For Mice: Apply 4 g Racumin foam (a foam the size of a tennis ball) to 30 g. Apply at least 2 m from storage locations for food and animal feeding stuffs. Per burrow / track: For Rats: Apply 20 g to 30 g Racumin foam (a foam the size of a half brick).	No	No	No

ROMAX BROMABLOCK

UK AUTHORISATION NUMBER
UK-2013-0741-002

ACTIVE % & TYPE	AREA OF USE	EFFECTIVE AGAINST	DOSAGE / QUANTITY GUIDE	PERMANENT BAITING APPROVED	BURROW BAITING APPROVED	PULSED BAITING APPROVED
Bromadiolone 0.005 % (w/w) & Denatonium Benzoate 0.001 %	Indoors and outdoors (around buildings) and sewers.	Rats and Mice	House Mice: High infestations: up to 50 g of bait per baiting point every 2 metres. Low infestations : Up to 50 g of bait per baiting point every 5 metres. Brown Rats: High Infestations: Up to 100 g of bait per baiting point every 5 metres. Low Infestations: Up to 100 g of bait per baiting point every 10 metres.	Yes	No	No

ROMAX B WHOLE WHEAT

UK AUTHORISATION NUMBER
UK-2013-0729-004

ACTIVE % & TYPE	AREA OF USE	EFFECTIVE AGAINST	DOSAGE / QUANTITY GUIDE	PERMANENT BAITING APPROVED	BURROW BAITING APPROVED	PULSED BAITING APPROVED
Bromadiolone 0.005% (w/w)	Indoors and Outdoors (around buildings).	Rats and Mice	House Mice: High Infestations up to 50 g of bait per baiting point every 2 metres. Low Infestations up to 50 g of bait per baiting point every 5 metres. Brown Rat: High infestations 100 g of bait per baiting point every 5 metres. Low Infestations 100 g of bait per baiting point every 10 metres.	Yes	No	No

ROMAX D BLOCK				UK AUTHORISATION NUMBER UK-2011-0077		
ACTIVE % & TYPE	AREA OF USE	EFFECTIVE AGAINST	DOSAGE / QUANTITY GUIDE	PERMANENT BAITING APPROVED	BURROW BAITING APPROVED	PULSED BAITING APPROVED
Difenacoum 0.005% (w/w)	Indoors and around buildings, in open areas, waste dumps and sewers.	Rats and Mice	Mice: 40 g every 5 m reducing to 2 m for high infestations. Rats: 200 g every 10 m reducing to 5 m for high infestations	Yes	Yes	No

ROMAX D BAIT BLOCKS - 25 PPM				UK AUTHORISATION NUMBER UK-2016-0994-0005		
ACTIVE % & TYPE	AREA OF USE	EFFECTIVE AGAINST	DOSAGE / QUANTITY GUIDE	PERMANENT BAITING APPROVED	BURROW BAITING APPROVED	PULSED BAITING APPROVED
Difenacoum 0.0025% (w/w) Dentatonium Benzoate 0.001% (w/w)	In and around buildings, in open areas, waste dumps and in sewers.	Rats and Mice	Mice: Low Infestation: Up to 40 g per bait point every 5 metres. High Infestations: Up to 40 g per bait point every 2 metres. Rats: Low infestations: Up to 200 g per baiting point every 10 metres. High Infestations: Up to 200 g per bait point every 5 metres. Sewers: Up to 200 g per manhole.	No	No	No

ROMAX D WHOLE WHEAT				UK AUTHORISATION NUMBER UK-2014-0808		
ACTIVE % & TYPE	AREA OF USE	EFFECTIVE AGAINST	DOSAGE / QUANTITY GUIDE	PERMANENT BAITING APPROVED	BURROW BAITING APPROVED	PULSED BAITING APPROVED
Difenacoum 0.005% (w/w)	Indoors and outdoors (around buildings), outdoors open areas and sewers.	Rats and Mice	Mice: Secure up to 50 g of product in a covered tamper resistant baiting station or covered bait points space 10 m apart (5 metres apart in high infestations). Rats: Secure up to 200 g of product in a covered tamper resistant baiting station or covered bait points space 10 m apart (5 metres apart in high infestations).	Yes	Yes	No

ROMAX DP PASTE				UK AUTHORISATION NUMBER UK-2013-0804		
ACTIVE % & TYPE	AREA OF USE	EFFECTIVE AGAINST	DOSAGE / QUANTITY GUIDE	PERMANENT BAITING APPROVED	BURROW BAITING APPROVED	PULSED BAITING APPROVED
Difenacoum 0.005% (w/w)	In and outdoors (around buildings).	Mice	Secure up to 4 g of bait into both corners of the bait box, as a guide place boxes 5 metres apart in high infestations and 10 metres apart for low infestations.	Yes	No	No

ROMAX MUSKIL BLOCK FLUO-NP

UK AUTHORISATION NUMBER
UK-2013-0757

ACTIVE % & TYPE	AREA OF USE	EFFECTIVE AGAINST	DOSAGE / QUANTITY GUIDE	PERMANENT BAITING APPROVED	BURROW BAITING APPROVED	PULSED BAITING APPROVED
Bromadiolone 0.0025 % (w/w) Difenacoum 0.0025 % (w/w) Denatonium Benzoate 0.001 % (w/w)	In and around buildings, in open areas, in waste dumps.	Rats and Mice	Mice: Use bait points of up to 50 g. Place bait 5 metres apart, reducing to 2 metres in areas of high infestations. Rats: Use bait points of up to 100 g. Place bait points 10 metres apart, reducing to 5 metres in areas of high infestation.	Yes	Yes	No

ROMAX MUSKIL PASTA SACHETS FLUO-NP

UK AUTHORISATION NUMBER
UK-2013-0756

ACTIVE % & TYPE	AREA OF USE	EFFECTIVE AGAINST	DOSAGE / QUANTITY GUIDE	PERMANENT BAITING APPROVED	BURROW BAITING APPROVED	PULSED BAITING APPROVED
Bromadiolone 0.0025 % (w/w) Difenacoum 0.0025 % (w/w) Denatonium Benzoate 0.001 % (w/w)	Indoors and outdoors around buildings, open areas and waste dumps.	Rats and Mice	For the control of House Mice (<i>Mus musculus</i>) - for use indoors and outdoors around buildings: High infestation: up to 50 g of bait per baiting point spaced 2 m apart; Low infestation: up to 50 g of bait per baiting point spaced 5 m apart. For the control of Brown Rats (<i>Rattus norvegicus</i>) - for use indoors and outdoors around buildings, in open areas and waste dumps: High infestation: up to 100 g of bait per baiting point spaced 5 m apart; Low infestation: up to 100 g of bait per baiting point spaced 10 m apart.	Yes	Yes	No

ROMAX MUSKIL WHOLE WHEAT

UK AUTHORISATION NUMBER
UK-2012-0661

ACTIVE % & TYPE	AREA OF USE	EFFECTIVE AGAINST	DOSAGE / QUANTITY GUIDE	PERMANENT BAITING APPROVED	BURROW BAITING APPROVED	PULSED BAITING APPROVED
Bromadiolone 0.0025 % (w/w) Difenacoum 0.0025 % (w/w) Denatonium Benzoate 0.001 % (w/w)	Indoors and outdoors (around buildings).	Rats and Mice	House Mice: High infestations: Up to 50 g of bait per baiting point every 2 metres. Low Infestations: Up to 50 g of bait per baiting point every 5 metres. Brown Rats: High Infestations: Up to 100 g of bait per baiting point every 5 metres. Low infestations: Up to 100 g of bait per baiting point every 10 metres.	Yes	Yes	No

ROMAX MUSKIL WHOLE WHEAT SACHETS

UK AUTHORISATION NUMBER
UK-2012-0661

ACTIVE % & TYPE	AREA OF USE	EFFECTIVE AGAINST	DOSAGE / QUANTITY GUIDE	PERMANENT BAITING APPROVED	BURROW BAITING APPROVED	PULSED BAITING APPROVED
Bromadiolone 0.0025 % (w/w) Difenacoum 0.0025 % (w/w) Denatonium Benzoate 0.001 % (w/w)	Indoors and outdoors (around buildings).	Rats and Mice	House Mice: High infestations: Up to 50 g of bait per baiting point every 2 metres. Low Infestations: Up to 50 g of bait per baiting point every 5 metres. Brown Rats: High Infestations: Up to 100 g of bait per baiting point every 5 metres. Low infestations: Up to 100 g of bait per baiting point every 10 metres.	Yes	Yes	No

ROMAX RAT CP				UK AUTHORISATION NUMBER UK-2016-0953-001		
ACTIVE % & TYPE	AREA OF USE	EFFECTIVE AGAINST	DOSAGE / QUANTITY GUIDE	PERMANENT BAITING APPROVED	BURROW BAITING APPROVED	PULSED BAITING APPROVED
Coumatetralyl 0.0375 % (w/w)	Indoors and Outdoors (around buildings).	Rats	Place 200 g of Romax Rat CP bait in tamper resistant bait stations or covered and protected baiting points spaced 5-20 metres apart (3-10 metres apart in areas of high infestations).	No	Yes	No

ROMAX VENOM BLOCKS				UK AUTHORISATION NUMBER UK-2015-0880-003		
ACTIVE % & TYPE	AREA OF USE	EFFECTIVE AGAINST	DOSAGE / QUANTITY GUIDE	PERMANENT BAITING APPROVED	BURROW BAITING APPROVED	PULSED BAITING APPROVED
Brodifacoum 0.005 % (w/w)	Indoors and Outdoors (around buildings).	Rats and Mice	<p>House Mice: High infestations: Up to 50 g of bait per baiting point every 2 metres. Low Infestations: Up to 50 g of bait per baiting point spaced every 5 metres.</p> <p>Brown Rats: High Infestations: Up to 100 g of bait per baiting point every 5 metres. Low infestations Up to 100 g bait per baiting point spaced every 10 m apart.</p>	No	Yes	No

ROMAX VENOM FRESH BAIT				UK AUTHORISATION NUMBER UK-2015-0857-0007		
ACTIVE % & TYPE	AREA OF USE	EFFECTIVE AGAINST	DOSAGE / QUANTITY GUIDE	PERMANENT BAITING APPROVED	BURROW BAITING APPROVED	PULSED BAITING APPROVED
Brodifacoum 0.0029 % (w/w)	Indoors, around buildings and sewers.	Rats and Mice	<p>For mouse infestations use 10 g up to 20 g of bait per bait point. Place bait points 5 m apart reducing to 2 m in high infestations.</p> <p>Rat Infestations us 10 to 60 g per bait point 10 m apart reducing to 5 m heavy infestations for Sewers- up to 200 g per manhole .</p>	No	Yes	Yes-indoors

ROMAX VENOM WHOLE WHEAT				UK AUTHORISATION NUMBER UK-2015-0883-004		
ACTIVE % & TYPE	AREA OF USE	EFFECTIVE AGAINST	DOSAGE / QUANTITY GUIDE	PERMANENT BAITING APPROVED	BURROW BAITING APPROVED	PULSED BAITING APPROVED
Brodifacoum 0.005 % (w/w)	Indoors and Outdoors (around buildings).	House Mice and Brown Rats	<p>House Mice: High infestations: Up to 50 g of bait per baiting point every 2 metres. Low Infestations: Up to 50 g of bait per baiting point spaced every 5 metres.</p> <p>Brown Rats: High Infestations: Up to 100 g of bait per baiting point every 5 metres. Low infestations Up to 100 g bait per baiting point spaced every 10m apart.</p>	No	No	No

ROMAX VENOM PASTA				UK AUTHORISATION NUMBER UK-2015-0881-005		
ACTIVE % & TYPE	AREA OF USE	EFFECTIVE AGAINST	DOSAGE / QUANTITY GUIDE	PERMANENT BAITING APPROVED	BURROW BAITING APPROVED	PULSED BAITING APPROVED
Brodifacoum 0.005 % (w/w)	Indoors and Outdoors (around buildings).	Rats and Mice	<p>House Mice: High infestations: Up to 50 g of bait per baiting point every 2 metres. Low infestations: Up to 50 g of bait per baiting point spaced every 5 metres.</p> <p>Brown Rats: High Infestations: Up to 100 g of bait per baiting point every 5 metres. Low infestations Up to 100 g bait per baiting point spaced every 10 m apart.</p>	No	No	No
ROMAX VENOM LIPOGEL				UK AUTHORISATION NUMBER UK-2016-1041-0002		
ACTIVE % & TYPE	AREA OF USE	EFFECTIVE AGAINST	DOSAGE / QUANTITY GUIDE	PERMANENT BAITING APPROVED	BURROW BAITING APPROVED	PULSED BAITING APPROVED
Brodifacoum 0.005 % (w/w)	Indoors and outdoors (around buildings).	Rats and Mice	<p>House Mice (<i>Mus musculus</i>) High infestations: Up to 50 g of bait per bait point spaced 2 m apart. Low infestations: Up to 50 g bait per baiting point spaced 5 m apart.</p> <p>Brown Rat (<i>Rattus norvegicus</i>) High infestations: Up to 100 g per baiting point spaced 5 m apart. Low infestations: Up to 100 g per baiting points spaced 10 m apart.</p>	No	No	No
RODILON WHEAT TECH				UK AUTHORISATION NUMBER UK-2011-0049-0001		
ACTIVE % & TYPE	AREA OF USE	EFFECTIVE AGAINST	DOSAGE / QUANTITY GUIDE	PERMANENT BAITING APPROVED	BURROW BAITING APPROVED	PULSED BAITING APPROVED
Difethialone 0.0025% (w/w)	Indoors and Outdoors (around buildings).	Rats and Mice	<p>Mice: Place up to 50 g of bait in tamper-resistant bait stations or covered and protected baiting points spaced 2-3 m (low infestation) or 1-1.5 m (high infestation) apart in areas where mice are active (e.g. wherever damage, droppings or evidence of mice activity has been found).</p> <p>Rats: Place up to 200 g of bait, in tamper-resistant bait stations or covered and protected baiting points spaced 8 - 10 metres (low infestation) or 4-5 m (high infestation) apart in areas where rats are active (e.g. nesting areas, on rodent runs, along walls and where evidence of droppings have been found).</p>	No	No	No
RODILON TRIO				UK AUTHORISATION NUMBER UK-2011-0050		
ACTIVE % & TYPE	AREA OF USE	EFFECTIVE AGAINST	DOSAGE / QUANTITY GUIDE	PERMANENT BAITING APPROVED	BURROW BAITING APPROVED	PULSED BAITING APPROVED
Difethialone 0.0025% (w/w)	Indoors and outdoors (around buildings).	Rats and Mice	<p>Mice: Place up to 50 g of bait (5 sachets of 10 g each), in tamper-resistant bait stations or covered and protected baiting points spaced 2-3 m (low infestation) or 1-1.5 m (high infestation) apart in areas where mice are active (e.g. wherever damage, droppings or evidence of mice activity has been found).</p> <p>Rats: Place up to 200 g of bait (20 sachets of 10 g each), in tamper-resistant bait stations or covered and protected baiting points spaced 8-10 m (low infestation) or 4-5 metres (high infestation) apart in areas where rats are active (e.g. nesting areas, on rodent runs, along walls and where evidence of droppings have been found).</p>	No	No	No

RODILON SOFT BLOCKS				UK AUTHORISATION NUMBER UK-2011-0003-0004		
ACTIVE % & TYPE	AREA OF USE	EFFECTIVE AGAINST	DOSAGE / QUANTITY GUIDE	PERMANENT BAITING APPROVED	BURROW BAITING APPROVED	PULSED BAITING APPROVED
Difethialone 0.0025% (w/w)	Indoors, around buildings and sewers.	Rats and Mice	Mice: Place up to 50 g of bait (5 sachets of 10 g each), in tamper-resistant bait stations or covered and protected baiting points spaced 2-3 m (low infestation) or 1-1.5 m (high infestation) apart in areas where mice are active (e.g. wherever damage, droppings or evidence of mice activity has been found). Rats: Place up to 200 g of bait (20 sachets of 10 g each), in tamper-resistant bait stations or covered and protected baiting points spaced 8-10 m (low infestation) or 4-5 m (high infestation) apart in areas where rats are active (e.g. nesting areas, on rodent runs, along walls and where evidence of droppings have been found).	No	No	No
SOLO SUPER BLOX				UK AUTHORISATION NUMBER UK-2015-0905		
ACTIVE % & TYPE	AREA OF USE	EFFECTIVE AGAINST	DOSAGE / QUANTITY GUIDE	PERMANENT BAITING APPROVED	BURROW BAITING APPROVED	PULSED BAITING APPROVED
Brodifacoum 0.005% (w/w)	In and around buildings and in Sewers.	Rats	Rats: 1 block in covered tamper resistant bait stations or covered bait points every 5 to 10 metres.	No	No	No
SOLO BLOX				UK AUTHORISATION NUMBER UK-2015-0905		
ACTIVE % & TYPE	AREA OF USE	EFFECTIVE AGAINST	DOSAGE / QUANTITY GUIDE	PERMANENT BAITING APPROVED	BURROW BAITING APPROVED	PULSED BAITING APPROVED
Brodifacoum 0.005% (w/w)	In and around buildings.	Rats and Mice	Mice: High infestation: 1 block in covered tamper resistant bait stations or covered bait points every 2 metres. Low infestation: 1 block in covered tamper resistant bait stations or covered bait points every 5 metres. Rats: High infestation: 1-3 blocks in covered tamper resistant bait stations or covered bait points every 5 metres. Rats: Low infestation: 1-3 blocks in covered tamper resistant bait stations or covered bait points every 10 metres.	No	No	No
SOREXA D				UK AUTHORISATION NUMBER UK-2012-0319		
ACTIVE % & TYPE	AREA OF USE	EFFECTIVE AGAINST	DOSAGE / QUANTITY GUIDE	PERMANENT BAITING APPROVED	BURROW BAITING APPROVED	PULSED BAITING APPROVED
Difenacoum 0.005% (w/w)	Indoor use only.	Mice	Up to 30g of bait per bait point placed 1-2 metres apart.	No	No	No

STORM SECURE BLOCKS				UK AUTHORISATION NUMBER UK-2015-0850		
ACTIVE % & TYPE	AREA OF USE	EFFECTIVE AGAINST	DOSAGE / QUANTITY GUIDE	PERMANENT BAITING APPROVED	BURROW BAITING APPROVED	PULSED BAITING APPROVED
Flocoumafen (0.005% w/w)	In and around buildings and in sewers.	Rats and Mice	<p>Mice: Up to 20 g (1 block) per bait point placed 1-2 metres apart.</p> <p>Rats: 40-60 g (2-3 blocks) per bait point placed 5 - 10 metres apart.</p> <p>Burrow baiting: Up to 40-60 g (2-3 blocks) of bait per burrow.</p>	No	Yes	Yes

STORM ULTRA SECURE BLOCKS				UK AUTHORISATION NUMBER UK-2018-1164-0001		
ACTIVE % & TYPE	AREA OF USE	EFFECTIVE AGAINST	DOSAGE / QUANTITY GUIDE	PERMANENT BAITING APPROVED	BURROW BAITING APPROVED	PULSED BAITING APPROVED
Flocoumafen 0.0025% (w/w)	In and around buildings only.	House Mice (<i>Mus musculus</i>) Brown Rats (<i>Rattus norvegicus</i>) Black Rats (<i>Rattus rattus</i>)	<p>Mice: 25 g per bait point spaced a minimum of 1-2 m apart.</p> <p>Rats: 50-75 g per bait point or burrow minimum distance 5-10 m apart.</p>	No	Yes	Yes

TALON PELLETS				UK AUTHORISATION NUMBER UK-2015-0908-0001		
ACTIVE % & TYPE	AREA OF USE	EFFECTIVE AGAINST	DOSAGE / QUANTITY GUIDE	PERMANENT BAITING APPROVED	BURROW BAITING APPROVED	PULSED BAITING APPROVED
Brodifacoum 0.005% (w/w)	Indoors and Outdoors (around buildings).	Rats and Mice	<p>Mice: Secure 5-25 g of bait in covered tamper resistant bait stations or covered bait points spaced 5 m apart (2 m apart in high infestation areas) in areas where mice are active.</p> <p>Rats: Secure 20-50 g of bait in covered tamper resistant bait stations or covered bait points spaced 10 m apart (5 m apart in high infestation areas) in areas where rats are active.</p>	No	No	No

TALON SOFT BAIT				UK AUTHORISATION NUMBER UK-2015-0910		
ACTIVE % & TYPE	AREA OF USE	EFFECTIVE AGAINST	DOSAGE / QUANTITY GUIDE	PERMANENT BAITING APPROVED	BURROW BAITING APPROVED	PULSED BAITING APPROVED
Brodifacoum 0.005% (w/w)	Indoors and Outdoors (around buildings).	Rats and Mice	<p>Mice: Secure 8 g of product (4 g in both corners of the bait box) in covered tamper resistant baiting stations or covered bait points spaced 10 m apart (5 m apart in areas of high infestations).</p> <p>Rats: Secure 50-200 g of product.</p>	No	Yes	No

TALON WAX BLOCKS				UK AUTHORISATION NUMBER UK-2015-0907-0001		
ACTIVE % & TYPE	AREA OF USE	EFFECTIVE AGAINST	DOSAGE / QUANTITY GUIDE	PERMANENT BAITING APPROVED	BURROW BAITING APPROVED	PULSED BAITING APPROVED
Brodifacoum 0.005 % (w/w)	Indoors, outdoors (around buildings) and in sewers.	Rats and Mice	<p>Mice: Secure 20 g of bait in tamper resistant bait stations or covered bait points spaced 5 m apart (2 m apart in high infestations areas)</p> <p>Rats: Secure 20-60 g of bait in tamper resistant bait stations or covered bait points spaced 10 metres apart (5 m apart in high infestations).</p> <p>In Sewers: Rats, secure 20-200 g of bait blocks per station to available structures to ensure blocks are not washed away.</p>	No	Yes	No

A-Z RODENTICIDE & RODENT CONTROL PRODUCTS

MINT

EXCLUSIVE MEMBERSHIP



Join our exclusive Mint Membership
it's 100% free.

Register today online or contact our sales office

Email: beh@barrettine.co.uk | www.barrettineEnv.co.uk

Mint Members enjoy
UP TO
20% OFF
PLUS PROMOTIONAL SAVINGS



THE BENEFITS...

- Exclusive promotions each month
- 20% off our entire catalogue in your first month of membership
- Prize draw each month worth £100 of free stock
- Free Mint Torch when you join
- Free Mint event & training days

Barrettine
Environmental Health

TERMS & CONDITIONS

TERMS & CONDITIONS

1. All products are offered for sale subject to our standard conditions of sale. Full terms and conditions are available on request.
2. All prices quoted are exclusive of VAT and are subject to alteration without notice.
3. We would especially draw your attention to the following standard conditions:
Nett Cash Monthly to Approved Accounts. Carriage is paid on orders of £245 or more for standard next day delivery, unless otherwise specified.
For orders of a lesser value a small surcharge of £8.25 per invoice will be raised to meet cost of processing small orders. Carriage is charged at cost to deliveries off the mainland such as offshore islands.
4. Notification of non-delivery must be made in writing within seven days from the date of despatch of the goods or else claims cannot be entertained.
5. Barretine cannot take responsibility for any associated costs arising from delivery issues (such as late or failed delivery), or delivery of wrong items and neither Barretine, nor our courier company take any responsibility if the clients request we leave goods unsigned.
6. Returns Policy - Should you return the Goods in accordance with our Terms & Conditions stated above, we reserve the right to charge a "restocking fee" which will be an amount equivalent to 15% of the price payable by you in respect of the returned Goods.

Should you wish to return anything bought from us, we will be happy to refund or exchange a product provided it is in a fully resaleable condition however you will be responsible for the postage and any associated cost and risk of the return of the goods to us.

If you wish to return your order we must receive notification within 14 calendar days from receipt of your goods. If we find that the product has not been returned to us in a fully resaleable condition, we reserve the right to refuse a refund on the item.

SPECIAL CONDITIONS OF SALE

Poisons

These products are subject to the Poisons Rules and can only be supplied to authorised purchasers against a signed official order stating the purpose of which it is to be used.
Please note: These items cannot normally be supplied on a next day delivery.

Pesticides

All pesticides listed are approved by ministers under the Control of Pesticides Regulations 1986 and the Control of Pesticides Regulations (Northern Ireland) 1987. Control of Pesticides - superseded by the European Biocides Directive where appropriate.

The Health and Safety Executive (HSE) in the United Kingdom is responsible for administering the Control of Pesticides Regulations (COPR) regulatory scheme in relation to non-agricultural pesticides and is also responsible for regulating biocides in the UK. The Control of Pesticides Regulations 1986 (COPR) (as amended 1997) with products controlled under COPR are gradually moving over to be regulated under the Biocidal Product Register (BPR), with COPR eventually becoming redundant. In addition to the COPR and the BPR, Article 95 of EU BPR (as amended) introduces an approved active substance supplier list. Article 95 of EU BPR applies to all products that are approved under the Control of Pesticides Regulations (COPR). Article 95 (2) of EU BPR (as amended) states "As of 1 September 2015, a biocidal product consisting of, containing or generating a relevant substance, included in the list referred to in paragraph 1, shall not be made available on the market unless either the substance supplier or the product supplier is included in the list referred to in paragraph 1 for the product-type(s) to which the product belongs."

Efficacy: Biocidal and non-biocidal products have varying rates of efficacy in the field and product labels should always be referred to in order to maximise efficacy.

INDEX

A

A2/AX/P3 Canister Filter	197
A1, A2, P1, P3 - 3M Filters	198
Acclaim 2000 Aerosol	18
Acheta Pest Control Manuals	188
Actellic 50 EC	40
Adhesive Tube Cutter	154
Accu Sprayer	164
Aerosols	18-19
Alcohol Surface Cleaner	118 & 208
Alcohol Hand Sanitiser	118 & 208
Alpha Express Blocks	72
Alpha SCT Concentrate	5
Aluminium Phosphide	110-11
Anti-static Fluid	1117
Application Equipment	160-188
Applicator Gun	176-177
Ant Baits	13-15
Ant Bait Stations	13, 15, 26
Ant Control	13-15
Aquatain AMF	12
AquaPy & Aquapy Micro	5 & 39
Aspivenin Sting Reliever	51 & 195
Avifix Adhesive	154
Avipoint Spikes	146
Avishock Connectors	153
Avishock Energisers	153
Avishock Lead Wire	154
Avishock Track	153
Avishock Tools	155
Avisil Adhesive	154
A-Z Insecticides	220-235
A-Z Rodenticides	236-249

B

B & G Accu Sprayer	164
B & G Bulb Duster	175
B & G Electric Duster 2250	175
B & G Hard Carry Case	205
B & G Fogger	161
Bags, Holdall	204
Bait Bags	121
Bait Boxes	76-83
Bait Box Anchors	84
Bait Box Fixings	84
Bait Box Insect Monitor	20 & 81
Bait Box Keys	75 & 83
Bait Box Labels	124-125
Bait Box Key Set	83
Bait Guns	176-177
Bait Safe Litter Bin	98
Bait Trays	84
Bait Tubes	75
Batteries	182
Barn Fly Catcher	29
Bayer Flying Insect Killer	18
Bed Bug Treatments	22-23
Bee/Wasp Protective Clothing	201-203
Biopren BMS	13
Biopren 6 EC	7
Bird Control	126-159

Bird Dishes	127
Bird Kite	158
Bird Mesh	156
Bird Net Brackets	138
Bird Net Clips	142
Bird Net Labelling	133
Bird Net Fixings	134-137
Bird Net Staples	142-143
Bird Net Ties	143
Bird Net Tools	143
Bird Netting	130-133
Bird Net Magnets	137
Bird Net Roof Fixings	140-141
Bird Net Wire Rope	138-139
Bird Net Zips	142
Bird Posts	150-153
Bird Proofing	156-157
Bird Scaring Devices	158-159
Bird Spikes	146
Bird Spike Clips	147
Bird Repellent	127
Bird Stopper	149
Bird Traps	157-158
Bird Waste Cleaning	127
Bird Wire Rope Fixings	139
Bite & Sting Reliever	51 & 195
BPCA Pest Manual	188
Brush Strips	103
Bumper Seal	105

C

Cable & Zip Ties	142-143
Canister Mask Filters	197
Canister Masks	196
Carcass Disposal Bags	121
Cardboard Bait Box	83
Carry Bags & Carry Cases	204-205
Cartridge Masks	198
Cartridge Mask Filters	198-199
Catchtray Circline	48
Cat (Feral) Trap	95
Caulking Gun	177
Caustic Soda	211
Chemical Spillage Kits	206
Cimetrol Super EW	5
Cimetrol Super RFU	19
Cimex Eradicator	23
Cimex Eradicator Accessories	23
CL Tab & Dispenser	32
Cleaning	208 & 211
Cleaning Tools	211-212
Clean Rest Mattress Covers	23
Clipper Steel Wire Wool	102
Clothes Moth Insect Monitors	32
Cluster Fly Tray	48
CO2 Cartridges	169
Cockroach Baits	15
Cockroach Traps	24
Contrac Blox	58
Contact Station	53
Contrac Super Blox	58
Contract Sachets	60

Containers	123
Coopex Smoke Generators	17
Copper Slug Tape	35
Coveralls	190
CreoSolve	43
Creosote	43
Crimping Tool	144
Curb Animal Repellent	117
Cyrol Forte range	9

D

Daddi Long Legs	157
Dash Camera	187
Deadline Bromadiolone Wheat	60
Deadline Bromadiolone Paste	61
Deadline Difenacoum Wheat	64
Deadline Difenacoum Paste	64
Deadline Insectaban	37
Deadline Non-Toxic Paste	74
Deadline PyDust	9
Deadline Tracking Gel	73
Deadline Wasp Nest Destroyer	18
Decanting & Mixing	178-179
Decis Protech	41
Degeesch Fumigation Plates	112
Delta Trap	30
Deodorising Products	122
Detex Blox & Detex Soft Bait	74
Dethlac Insecticidal Lacquer	18
Diatomaceous Earth	10
Difenacoum Rodenticides	61-65
Disinfectants	208-211
Disposable Coveralls	190
Disposable Wasp Bag	27
Dog & Fox Trap	96
Do Not Touch Labels	125
Drain Lifting Keys	116
Drain Blocker	116
Drain Cleaner	125
Drainage Systems	114-116
Drain Unblocker	210-211
Drager Pac Gas Detector	113
Drill (Cordless)	182
Drill Bits	145
DR5 Duster	172
Duomax Disinfectant Wipes	208
Duomax Disinfectant	208
Dusters	172-175
Duster Spare Parts	174
Dust & Wettable Powders	9
Dust Applicators	172-175
Dust Pan & Brush	212
DR5 Dust Applicator & spares	172-173
Dustick Applicator	174
Dustick Accessories	174
Dustick Bag	174
DX Triple Max Bait Stations	15
DX Triple Max Syringe	15
Dynafoog Foggers	162

INDEX

E

Ear Defenders	194
Ecoplug Drill Bit	45
Ecoplug Max	45
Electronic Fly Killers & Tubes	46-49
Electronic Mouse / Rat Trap	85
Entrap	31
Evo Express Box	76
Evo Tunnel	77
Exosex - Clothes Moth	32
Exosex - Stored Product Moth	36
Expanding Foam	100
Expanding Foam Gun	100
Eye Wash	207

F

Face Mask	196-200
Face Mask 3M	198
Faceshield	194
Fenn Traps Mk 4 & Mk 6	94
Feral Cat Trap (Metal Mesh)	95
Ficam D	9
Ferret Pro	184
Ferret Pro Stick	184
Ferret Pro Wristband	185
Filter 3M A1 & A2	198
Filter B2/P3	197
Filters For Masks	197-199
First Aid Kit	207
Fix All Adhesive	99
Fixx-it Tape	179
Flea Traps	35
Flexible Aerosol Straw	168
Flexible Pick Up Tool	182
Flymax Super G3	7
Fly Bag	28
Fly Glue Boards & Accessories	48-49
Fly Mesh	29
Fly Killer Tubes	49
Fly Strips	29
Fly Traps	28-29
Fly Unit Accessories	48-49
Fly Unit Glue Boards	48
Fly Unit Starters	48
Fly Unit Tubes	49
Fly Units	46-47
Foam Gun Cleaner	100
Foggers	161-162
Folding Ladder	216
Formidor	13
Forte Fog Jumbo	17
Fox Trap	96
Fruit Fly Traps	28
Full Face Respirator	196 & 198
Fumigation Plates	112
Fumigants and Accessories	110-113
Fungicide	43-44
Funnel	178

G

Gallup Bio Amenity	42
Gallup Home & Garden	42
Gallup XL	42
Gas Detection	113
Gel Canteen	26
Gel Knee Pads	195
Gloria Sprayers & Spares	164-165
Gloria Spares	166-167
Gloves, Beekeeper	203
Gloves, Latex	193
Gloves, Leather	203
Gloves, Nitrile	191-193
Gloves, PVC	192
Gloves, Vinyl	192
Gloves	191-193
Glue Boards (Rodent)	106-109
Glue Release Agent	107
Glue Solvent	107
Gorilla Wipes	119
Goggles	153-154
Goliath Gel	15
Grain Store Hygiene	39-40
Grain-Tect ULV	39
Grazon Pro	41
Grey Squirrel Feed	94
Guanaway	127
Guano Cleaning	127
Gull Bird Wire	152
Gull Nets	132

H

Habitat Management	42-45
Hand Sanitisers	118 & 208
Hand Scraper	211-212
Hand Soap & Dispenser	119
Hand Sprayers	170
Hand Wipes	119 & 208
Harmonix Monitor Paste	74
Harmonix Poultry Red Mite	37
Heavy Duty Plastic Sacks	121
Hex Drive Sockets	145
Hi Visibility Vest	195
Hidden Kill Mouse Trap	89
Hogring Staples	142-143
Humane Despatcher	158
Hygiene & Disinfectants	208-211

I

Igebo Nebulo Fogger	162
Insectaban	37
Insect & Mouse Traps	20-22
Insect & Weed Control	41-42
Insect Control	4-51
Insect Monitors	20-24
Insect Sampling	50-51
Insect Pheromones & Lures	33-34
Insecticide Concentrates	5-7
Insecticide Dusters	172-175
Insecticide Dusters Spares	174

Insecticide Hand Sprayers	170
Insecticide Sprayers	164-165
Insecticide Sprayers Spares	166-168
Inspection Camera	184
Inspection Light	214

K

K-Othrine Partix	5
K-Obiol EC25	40
Knee Pads	195
Knock Out Cleaning Range	201-211
Knockout D Block	64
Knockout D Pasta Sachet	64
Knockout D Wheat Sachet	71

L

Ladder Clamps	183
Ladders, Steps & Accessories	183
Laser Strike	158
Larsen Cage Trap	97
LED Fly Machines & Spares	46-47
Lignum Insecticide	44
Litter Bins	98
Litter Pickers	120
Live Catch Traps	95-97
Lo Line Cockroach Trap	24

M

Masks, Respirators & Filters	196-200
Maglite Torch	213
Maglite Torch Accessories	213
Maglite, Mini Torch	213
Magnifying Loupe	51
Magnetic Telescopic Tool	215
Magnets for Bird Nets	137
Magnum Spring Traps	92
Mattress Covers	23
Maxforce Platin	15
Maxforce Pushbox	13
Maxforce Quantum	13
Measuring Jug	178
Measuring Scoop	179
Memory Card	187
Mesh for Birds	156
Mesh for Rodents	101-102
Metal Bin	98
Metex Unikey	116
Mink Traps	95
Mint Application	250
MiteMax RTU	12
MoBe Moat	20-107
MoBe Combo Trap Mk.2	36
Mole Traps	93-94
Mole Trap Pliers	94
Motion Sensor Camera	86 & 187
Moth Lures	33
Moth Monitoring	32
Moth Trap	32
Moulded Respirators	200
Mouse Bait Stations	81-83

INDEX

N

Neosorex Blocks	63
Neosorex Gold	63
Neporex	37
Net Clips	142
Net Shears	144
Net Magnets	137
Net Repair Twine	43
Net Zips	142
Netting	130-133
Non-Return Valve	116
Nordisk Rat Blocker	114
Nozzles	99
Nut Spinner 7mm	145

O

Oa2ki Aerosol	10 & 12
Oa2ki Concentrate	10
Oa2ki Powder	10
Overboots / Overshoes	191
Ornaway Bird Repellent	127

P

P1 Filter	198
P2 Filter	199
P3 Filter	197-199
PA2 Powder Applicator	169
Paper Towels	119
Paperwork and Labels	124-125
Pathway & Patio Cleaner	45
Parvo Kill	117
Permost Uni Fly Spray	7
Personalised Labels	124
Pest Monitor	90
Pesticide Carry Cases	204-205
Pesticide Free Technology	10-12
Phosphine Dosimeter Tubes	113
Phostoxin Tablets & Accessories	110-111
Phusion	45
Pigeon Bird Wire	150-152
Pigeon Nets	131
Pigeon Traps	95 & 157
Plastic Bait Trays	84
Plastic Insect Monitors	22
Poison Labels	125
Polvo Powder	206
Polythene Sheeting	112
PPE & Safety	189-217
Prevent Spray	19
Pre-Baited Glue Pad	22
Prickler Strip	157
Priest Bat Dispatcher Club	108
Pre-baited Clothes Moth Holder	32
Promask Cannister	196
Proofing Materials	100-105
Proofing Mesh	101-102
Proofing Sealants	99
Protecta Evo Ambush	76
Protecta Evo Edge	81

Protecta Evo Landscape	76
Protecta Evo Circuit	75
Protecta HD & LP	77
Protecta Shield	76
Protecta Sidekick	77
Protective Clothing	190-203
Protective Gloves	191-193
Protective Overboots/Shoes	191
Protector Natural Aerosol	19
Protector One Shot	19
Provoke Mouse	91
Provoke Rat	91
Powder Application Kits	168
Putange Mole Trap	94
Putange Pliers	94
Pybuthrin 33	37
PyDust	9

Q

Quantum Ant Bait	13
Quicklock Durabait	78
Quicklock Microbait	83
Quicklock Ultra	79

R

Rabbit Cage Traps	96
Racumin Foam	53
Rat Tape - Metex	105
Rat Blocker	114
Rat CP	53
Rat Traps	88-89
Rat Wall & Accessories	114
Rat & Squirrel Traps	96
Raxit Door Seal	104
Red Top Fly Trap	28
Residex P	38
Respirators	200
Rentokil Clothes Moth Killer	32
Respirators	199-200
Replacement Insect Glue Pads	20 & 22
Replacement Visor	194
Rodent Baiters Mice	82
Rodent Baiter Rat	78
Rodent Bait Stations	75-79
Rodent Cleaning Tools	120-121
Rodent Control	52-125
Rodent Deodorising	122
Rodent Deterrent Strip	104
Rodent Dispatcher Club	108
Rodent Disposable Kits	120-121
Rodent Drainage Systems	114-116
Rodent Feed	91
Rodent Glue Boards	106-109
Rodent Hygiene/Disinfectants	117-119
Rodent Indicators	73-74
Rodent Lures	91
Rodent Mesh	101-102
Rodent Monitoring	73-74
Rodent Repellents	113
Rodent Sensor Technology	86
Rodent Spring Traps	92
Rodent Proofing	99-105
Rodent Traps	88-89
Rodenticides	53-72
Rodenticides-Alphachloralose	72
Rodenticides-Brodifacoum	67-72
Rodenticides-Bromodiolone	58-61
Rodenticides-Brom/Difen	55-57
Rodenticides-Coumatetralyl	53
Rodenticides-Difelhialone	65
Rodenticides-Difenacoum	62-64
Rodenticides-Flocoumafen	67
Rodilon Bait Blocks	65
Rodilon Trio	65
Rodilon Wheat	65
Roguard Xtra Bait Box	78
Romax B Whole Wheat	58
Romax Bromablock	58
Romax D Bait Blocks	62
Romax Bait Box Keys	75
Romax Bait Stations	75 & 81
Romax Bait Tube	75
Romax Contact Station	53
Romax Cube	86
Romax D Block 25	62
Romax D Wheat Sachets	62
Romax D Whole Wheat	61
Romax DP Paste	62
Romax E-Trap	86
Romax Glue Boards	106
Romax Glue Solvent	20 & 107
Romax Grey Squirrel Feed	94
Romax Mouse Box	81
Romax Mouse Box Floor	81
Romax Muskil	56
Romax Rat CP	53
Romax Rodent Feed	91
Romax Rodent Seal	99
Romax Snap-R Traps	88
Romax Pre-baited Glue Pads	81
Romax Tracking Dust	73
Romax Venom Fresh Bait	67
Romax Venom Range	67-69
Romax Venom Lipogel	69
Roof Net Fixings	140-141
Rural Hygiene	37-38

S

Safety Glasses	194
Safety Goggles	194
Safety Helmet	193
Sample Pot (insect)	50
S-clips	143
Scout Repellent	113
Scraper	121
Screw Eye Driver	143
Sealant	99 & 154
Seesnake Inspection Camera	185
Serrico Traps	36

INDEX

Sharps Bins & Disposal	206	Trap Funnels	95 & 157	X	
Shovel / Spade	212	Trap Tunnel	92	Xcluder	102
Silirub Sealant	99	Trapper Glue Boards	106	Xcluder Door Sweeps	105
Sirius	12	Trapper Pest Monitor	90	XL8 Extension	171
Slug, Snail & Flea Traps	35	Trapper T-Rex Traps	89	Xlarv Mosquito Control	38
Small Fly Sticky Boards	29	Trappit Beetle Insect Monitor	30		
Smoke Generators	17	Treatment Report Pads	124	Y	
Snap Trap - T-Rex	89	Trip Trap	90	YI Dash Cam	187
Snap Traps	88-89				
Soap Dispenser	119 & 209	U			
Solar Panel Proofing	149	ULV Applicator	40 & 163		
Solo Blox	71	ULV Fogger	163		
Solo Super Blox	71	Ultra Bait VR Metal Rat Box	79		
Sorex D Mouse Bait	63	Ultra Bait VR Metal Mouse Box	83		
Sorgene Extra	38 & 117	UV Torch	73 & 181		
Sparrow Cage Trap	157	UV Tubes	49		
Sparrow Nets	130				
Specimen Viewer	50	V			
Spectrum Lures	33	Vacuum (Hand held)	183 & 216		
SPI Monitors	30-31	Valved Disposable Respirator	200		
Spillage Kits	206-207	Venom Fresh Bait	67		
Spoon for Baiting	123	Venom Lipogel Bait	69		
Sprayers	164-165	Venom Pasta	69		
Sprayer Accessories	166-168	Venom Wheat	69		
Sprayer Extensions	171	Vertebrate Trap	97		
Spray Matic Hand Sprayer	170	Victor Clean Kill Tunnel	88		
Spring Traps	88-94	Victor Kill Vault Mouse Trap	88		
Squirrel and Mink Traps	95-97	Victor Rat and Mouse Trap	89		
Squirrel Feed	94	Void Inspection Cameras	184-185		
Starling Nets	132	Vulcan P5 Wasp Dust	9		
Storage Containers	178 & 205				
Stored Product Insect Traps	30-31	W			
Storm Secure	67	Warning Signs	155 & 207		
Surface Cleaner (Alcohol)	118 & 208	Wasp Bag	27		
Sting Reliever	51	Wasp Bait	27		
Storm Ultra	67	Wasp Nest Destroyer Foam	18		
Sorgene Xtra	117 & 209	Wasp/Bee Protection	201-203		
Surface Preparation	149	Wasp & Fly Liquid	27		
		Wasp and Fly Traps & lures	27-29		
T		Waste Storage Containers	178-179		
Talon Pellets	71	Water Soluble bags	23		
Talon Soft Bait	72	Watertight Non-Return Valve	116		
Talon Wax Blocks	72	WCS Tube Trap	92		
Talpex Mole Trap	93	Weed Control	41-42		
Talunex Spherical Tablets	111	Weils Card	108		
Talpirid Mole Trap	93	Weldmesh	102 & 156		
Technical Manuals	188	Weldmesh Clip	156		
Technicians Field Guide	188	Wire Brush	121		
Telescopic Ladder	183 & 216	Wire Cutters	144		
Terms and Conditions	251	Wire Rope	138		
Thermal Foggers	163	Wire Rope Fixings	139		
Tobacco Beetle & Moth Traps	36	Wire Wool	102		
Tools & Ladders	182-183	Wireless Inspection Camera	184-185		
Topex Applicator Kit	111	Wood Boring Insect Treatment	43-44		
Torches & Tools	180-183	Wood Preservation	43-45		
Tracing Dye	73	Wood Protective Treatments	43-44		
Tracking Dust	58 & 159	Wood Rotting Fungi Treatment	43-44		
Tracking Dust & Torch	73				
Traditional Creosote	43				
Transchem	205				

LET'S FIND THE SOLUTION TOGETHER.

OUR SERVICE*

Our Export department understands the requirements of our overseas customers and we offer a complete export service for our diverse range of products to global destinations. Dependant on the goods and the destination, our export department manages the Free Sales Certification as well as Certificates of Origin, hazardous packing and dangerous goods notices. The goods can be couriered direct, via freight forwarders or as consolidated freight.



EXPORT PROCESS



Telephone +44 (0) 117 967 2222 Email beh@barrettine.co.uk

*Some of our export products such as poisons, rodenticides and herbicides are subject to regional regulated approval and customers may wish to purchase on an Ex Works basis. For global shipping, we can arrange couriers to handle goods with the convenience of track and trace capability.

SUPPLIER OF TRUSTED
PEST CONTROL
SOLUTIONS

SAME DAY DISPATCH
EXPEDITED DELIVERY OPTIONS AVAILABLE

Next day before 9.30am and noon as well as Saturday deliveries available upon request. Free SMS email notification and tracking on offer. Please telephone the office for details.

The above services apply to the UK mainland (excluding Scotland) and are subject to goods being confirmed in stock at time of order.

Goods are also available to collect direct from the warehouse between 8.30am to 4pm every working day.

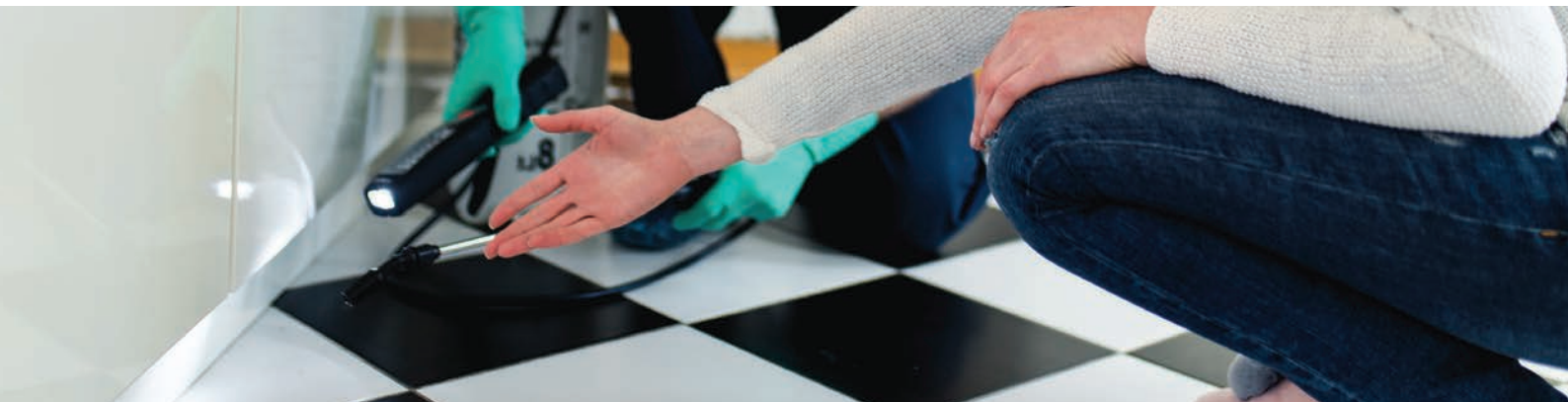

SAME DAY DISPATCH
EXPEDITED DELIVERY OPTIONS AVAILABLE

Place a confirmed order by telephone before 3.30pm and the consignment will be dispatched the same working day. Delivery time scales may vary depending upon courier performance and delivery options chosen at time of order.

NO CHARGE is made for standard delivery service for orders over £245.00 (excluding VAT) £8.25 charge for orders less than £245.00 (excluding VAT).



Prefer to pay by credit card? Order and pay online via our website or telephone your order/quote your mastercard visa number and your goods are on their way.

Unit 4 Caxton Business Park, Crown Way, Warmley, Bristol BS30 8XJ.
T. 0117 967 2222 E. beh@barrettine.co.uk www.barrettineEnv.co.uk

Barrettine Group Website: www.barrettine.co.uk

